



Updated Step 1 ATC TM System Requirements - Cycle 3

Document information

Project Title	ATC Trajectory Management Design
Project Number	10.02.01
Project Manager	EUROCONTROL
Deliverable Name	Updated Step 1 ATC TM System Requirements - Cycle 3
Deliverable ID	D88
Edition	00.03.00
Template Version	03.00.00

Task contributors

DFS; ENAV; EUROCONTROL; INDRA; NORACON; FINMECCANICA, THALES

Abstract

This document contains the Step 1 ATC technical requirements for Trajectory Management.

The document is developed in the form of a technical specification (TS/IRS), to be used as one of the primary inputs to the prototype development and verification phases.

The document has been produced in 2016 in order to update the Step 1 Requirements already produced by the project in previous years according to the latest step 1 inputs.

Rational for rejection
None.

Document History

Edition	Date	Status	Author	Justification
00.00.01	16/09/2015	Preliminary Draft	FINMECCANICA	Initial draft created from D87.
00.00.02	30/06/2016	Draft	FINMECCANICA	Review of the requirements on the basis of input from partners and validation results
00.00.03	03/08/2016	Final version	FINMECCANICA	Updated with inputs from review
00.01.00	12/08/2016	Final	Eurocontrol	Updated with the approval
00.02.00	29/09/2016	Final	FINMECCANICA	Update After SESAR JU Assessment
00.03.00	10/11/2016	Final	FINMECCANICA	Update After SESAR JU Assessment 2 ROUND

Intellectual Property Rights (foreground)

This deliverable consists of SJU foreground.

founding members



Avenue de Cortenbergh 100 | B -1000 Bruxelles
www.sesarju.eu

3 of 97

Table of Contents

EXECUTIVE SUMMARY	7
1 INTRODUCTION	8
1.1 PURPOSE OF THE DOCUMENT	8
1.2 INTENDED READERSHIP	8
1.3 INPUTS FROM OTHER PROJECTS	9
1.4 STRUCTURE OF THE DOCUMENT	11
1.5 REQUIREMENTS DEFINITIONS – GENERAL GUIDANCE	11
1.6 FUNCTIONAL BLOCK PURPOSE.....	12
1.6.1 <i>Trajectory Management</i>	12
1.6.2 <i>Initial 4D</i>	12
1.6.3 <i>Trajectory Prediction</i>	12
1.7 FUNCTIONAL BLOCK OVERVIEW	13
1.8 GLOSSARY OF TERMS	14
1.9 ACRONYMS AND TERMINOLOGY.....	15
2 GENERAL FUNCTIONAL BLOCK DESCRIPTION	20
2.1 CONTEXT	20
2.2 FUNCTIONAL BLOCK MODES AND STATES	21
2.3 MAJOR FUNCTIONAL BLOCK CAPABILITIES	22
2.4 USER CHARACTERISTICS	23
2.5 OPERATIONAL SCENARIOS.....	24
2.5.1 <i>Trajectory Management Framework and System Interoperability with air and ground data sharing (ENB 03.01.01 TMF)</i>	25
2.5.2 <i>Enhanced Arrival & Departure Management in TMA and En Route (OFA 04.01.02)</i>	26
2.6 FUNCTIONAL	27
2.6.1 <i>Functional decomposition</i>	27
2.6.1.1 Functional Breakdown of TP&M.....	27
2.6.1.2 Interactions of TP&M FB with other FB.....	28
2.6.2 <i>Functional analysis</i>	31
2.7 SERVICE VIEW	32
3 FUNCTIONAL BLOCK FUNCTIONAL AND NON-FUNCTIONAL REQUIREMENTS	33
3.1 CAPABILITIES	33
3.1.1 <i>Sequence Arrivals Capability</i>	33
3.1.2 <i>Issue/Cancel CTA Capability</i>	36
3.1.2.1 Issue CTA Instruction.....	39
3.1.2.2 Issue CTA Cancellation Instruction.....	43
3.1.2.3 Display CTA	44
3.1.2.4 Share Executive CTA Instructions	47
3.1.2.5 Air-Ground CTA Consistency Check	48
3.1.2.6 RTA Achievable / Not Achievable	50
3.1.3 <i>2D Route Capability</i>	51
3.1.3.1 Route Change.....	53
3.1.3.2 Full Route Clearance	54
3.1.3.3 Display Route Changes.....	55
3.1.3.4 Air-Ground Route Clearance Conformance Check	56
3.1.4 <i>Standard Arrival Procedures Capability</i>	58
3.1.4.1 Share STAR allocation	60
3.1.5 <i>Predict 4D Ground Trajectory Capability</i>	61
3.1.5.1 Predict Trajectory	61
3.1.5.2 Apply CTA	62
3.1.5.3 Improve TP with Mode-S ADD	63
3.1.5.4 Improve TP with FOC/WOC Flight Performance Data.....	65
3.1.5.5 Improve TP with ADS-C ADD	69

founding members



Avenue de Cortenbergh 100 | B -1000 Bruxelles
www.sesarju.eu

4 of 97

3.1.5.6	TP uncertainty.....	70
3.1.5.7	TP in PBN operations.....	71
3.1.5.8	Trajectory Calculation.....	72
3.2	PERFORMANCE CHARACTERISTICS.....	89
3.3	SAFETY & SECURITY.....	89
3.4	MAINTAINABILITY.....	89
3.5	RELIABILITY.....	89
3.6	FUNCTIONAL BLOCK INTERNAL DATA REQUIREMENTS.....	89
3.7	DESIGN AND CONSTRUCTION CONSTRAINTS.....	89
3.8	FUNCTIONAL BLOCK INTERFACE REQUIREMENTS.....	89
4	ASSUMPTIONS.....	90
5	REFERENCES.....	91
5.1	USE OF COPYRIGHT / PATENT MATERIAL /CLASSIFIED MATERIAL.....	92
5.2	TRACEABILITY.....	92
	APPENDIX A.....	93
	APPENDIX B.....	95

founding members



Avenue de Cortenbergh 100 | B -1000 Bruxelles
www.sesarju.eu

List of tables

No Tables.

List of figures

Figure 1 - Inputs to TS	10
Figure 2 functional breakdown for TP&M.....	20
Figure 3 TM Requirements Breakdown	22
Figure 4 Functional View.....	32
Figure 5 Arrival Sequence Domain Model	34
Figure 6: EAT implemented by CTA Allocation and Uplink	37
Figure 7 CTA Domain Model.....	38
Figure 8 CTA Operational state chart (HMI)	44
Figure 9: Route Domain	51
Figure 10 Route change impact on CTA.....	53
Figure 11 Route Change Operational Status Diagram	55
Figure 12 STAR in C-ATSU	59
Figure 13 STAR in D-ATSU	59

founding members



Avenue de Cortenbergh 100 | B -1000 Bruxelles
www.sesarju.eu

6 of 97

Executive summary

This document summarizes the Trajectory Management (TM) ATC System Requirements analysed and defined during all the 10.02.01 project life.

This specification describes trajectory management functionality of the ENR/APP ground system required to support step 1 validations mainly:

- the management of the 2D route including alignment and consistency between ground and air systems,
- the issuing and cancellation of CTA constraints, including alignment and consistency between ground and air systems
- STAR allocation and clearance in order to improve CDA and i4D operations
- the use of aircraft derived data (e.g. EPP) for improved ATC trajectory prediction accuracy.
- the use of data from FOC/WOC to improve trajectory prediction accuracy
- The management of 4D Ground Trajectory

As the functional block is a logical entity (function) and not a component of the system with defined interfaces (IRS), the subject of the requirements is “the system” as a whole rather than a particular functional block. Each requirement will be allocated to one or more functional blocks (typically TP&M).

This document, respect to the previous version D87, provides a review of the requirements and don't include additional requirements respect the previous version.

1 Introduction

1.1 Purpose of the document

This document contains a set of Trajectory Management ATC System Requirements for Step 1, specifically those trajectory management (TM) requirements related to Initial 4D (i4D) and improved trajectory prediction (TP).

This technical specification (TS) will be used for the development of the P10.2.1 prototypes, thereby allowing the validation of the operational concepts defined by WP4 and WP5.

The specification is prototype and release neutral and therefore is applicable for any release of a prototype. Not all requirements will be implemented by all prototypes.

1.2 Intended readership

The intended audience of this document is:

- The related primary operational projects [P04.05], [P05.06.01] and [P05.05.01]
 - To check that the system functionality is in line with the Trajectory Management Framework and will be able to support the operational scenarios and services.
- The SESAR Technical Architecture project [PB4.3]
 - To check that the ATC ENR/APP system and its interfaces are in line with the system of systems decomposition/architecture.
- The WP 10 federating project [P10.1.7]
 - To check that the functional block implements the assigned enablers and associated operational requirements.
 - To check for requirement duplication and consistency with other projects impacting on the same functional blocks.
- P10.2.2 & P10.2.5 Trajectory Management Projects
 - For information and review.
- Integrated Validation Projects [P4.3] and [P5.3]
 - To perform integrated validation using the prototypes based on this specification.
- Other WP10 projects
 - For information only.

1.3 Inputs from other projects

The following documents produced by operational projects have been used as input to this specification. These are the documents currently available at this time.

- 04.02 D98 - DOD Step 1
- 04.05 D822 TMF/IOP Technical Note for 2014
- 04.07.03 D06 - Updated OSED
- 05.05.01 D01 – OSED-Step 1
- 05.06.01 D74 – OSED-It3
- 05.06.01 M196 – SPR-It3
- 05.06.01 M197 – INTEROP-It3
- 05.06.04 D32 - OSED
- 05.06.04 D30 – SPR
- 04.07.02 D19 – OSED
- 04.07.02 D10 – OSED 3
- 04.07.02 D020 - SPR
- 05.06.04 D34 – Updated Step 1 ATC TM System Requirements - Cycle 3
- P5.5.1-D838-TMF-IOP co-ordination with OFA Report 2014 (16/03/2015)
- P4.5-D823- TMF INTEROP for Step 1 Initial Release (July 2015)
- P4.5 TMF-IOP Technical Note – Final (29/01/2016)
- P4.7.2-D11-Safety and performance Requirements_3 (10/01/2016)
- P5.5.1-D839-TMF-IOP co-ordination with OFA Report 2015 (15/12/2015)
- P4.7.2 D22-Preliminary OSED 4
- P5.5.1/4.5 TMF-IOP co-ordination with OFA Report 2014
- P5.5.1/4.5 TMF-IOP co-ordination with OFA Report 2015
- P4.7.2 D30 - Preliminary Safety and Performance Requirements for MTCD/TCT_4
- P4.7.2 D60 - Preliminary Safety and Performance Requirements for TRACT_4
- P5.7.2 D77-Preliminary V2 OSED for Step 1
- 5.7.2 D78-Preliminary V2 SPR for Step 1
- 5.7.2 D79-Preliminary V2 INTEROP for Step 2
- 10.01.07 D115 Technical Architecture Document (TAD) Cycle 4

founding members



Avenue de Cortenbergh 100 | B -1000 Bruxelles
www.sesarju.eu

9 of 97

The following diagram summarises the main inputs used in the production of this TS, and where they come from:

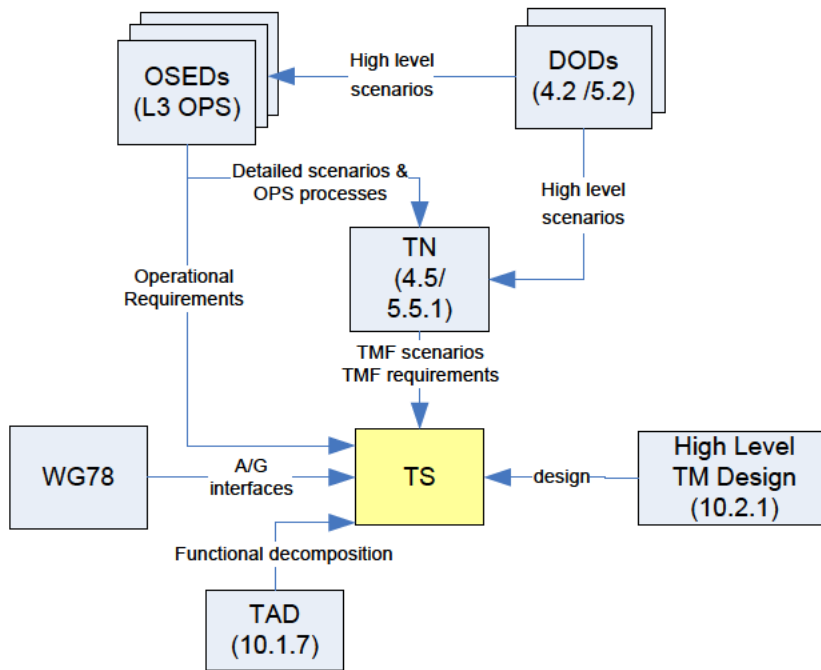

Figure 1 - Inputs to TS

1.4 Structure of the document

This document consists of following sections:

- Chapter 1: introduction; purpose and scope; requirements structure; and high level overview
- Chapter 2: General component description
- Chapter 3: Functional and Non-Functional Requirements

This section is divided into sub sections to specify the system requirements, that is, those characteristics of the system that are conditions for its verification. This section is divided into subparagraphs to collate together requirements associated with each capability of the system. A "capability" is defined as a group of related requirements relating to a specific system function.

Each requirement is assigned a project-unique identifier to support testing and traceability and stated in such a way that an objective test can be defined for it.

- Chapter 4: Assumptions
- Chapter 5: Referenced documents

1.5 Requirements Definitions – General Guidance

The requirements are grouped according to functional capabilities.

Requirements are numbered according to the following template:

REQ-10.02.01-TS-nnnn.mmmm

Where:

- nnnn=0001 identifies requirements originating from the Release 1 Specification (D03-001)
- nnnn=0002 identifies requirements originating from v2 of the Step 1 specification (D74)
- nnnn=0003 identifies requirements originating from v2b of the Step 1 specification (D74)
- nnnn=0004 identifies requirements originating from version v3 of the Step 1 specification (D74)
- nnnn=0005 identifies requirements originating from 2014 version of the Step 1 specification (D86)
- nnnn=0006 identifies requirements originating from 2015 and 2016 version of the Step 1 specification (D87)
- nnnn.mmmm is a unique number.

(Note that nnnn=000X, does not imply that the requirements are for release X; they can be for any release of any step)

This specification also contains some domain models to aid understanding. A domain model captures the entities and relationships in the domain of interest, therefore defining the vocabulary and key concepts of the problem domain.

founding members



Avenue de Cortenbergh 100 | B -1000 Bruxelles
www.sesarju.eu

11 of 97

1.6 Functional block Purpose

1.6.1 Trajectory Management

Trajectory management is defined by B4.2 as “The process by which the Business or Mission Trajectory of the aircraft is planned, agreed, updated and revised. It is achieved through Collaborative Decision Making (CDM) processes between Airspace Users (Aircraft Operators) and ATM Service Providers (Air Navigation Service Providers, Airports) or directly between the Flight Crew and the Controller during the execution phase when time does not permit CDM.”

Trajectory Management (TM) is a fundamental principle of Trajectory Based Operations (TBO), using 4D trajectories as the basis for planning and executing all flight operations supported by the air navigation service provider. Trajectory Management functionality is required to improve the trajectories to meet the high level objectives of TBO. The improvement of the trajectories may be an accuracy improvement and improvements related to the ability to manage (create, revise, update...) the local trajectories in synchronisation and collaboration with other stakeholders.

The ENR/APP ATC system plays a key role in the TM process and a specific TM & TP functional block has been created by P10.1.7 in order to encapsulate the ATC system functionality that directly supports the overall TM process. However several other functional blocks of the ENR/APP Ground System also support the TM process because Trajectory Management is a transversal function shared between geographically remote systems (air and ground) therefore Ground-Ground and Air-Ground Data Communication Functional Blocks are also crucial.

1.6.2 Initial 4D

One particular aspect of TM is Initial 4D (i4D). i4D is a first step towards a full implementation of 4D trajectory based operations utilising air-ground data link. The i4D concept includes the sharing of airborne and ground trajectories and flying to a single time constraint.

i4D brings improved predictability through improved trajectory prediction accuracy which in turn brings improved conflict detection resulting in fewer tactical instructions affecting the trajectory in the short term, i4D also brings increased automation resulting in improvements in capacity and safety, and improved flight efficiency through optimised speed and descent profiles.

1.6.3 Trajectory Prediction

Trajectory Prediction is the process of computing and predicting the future trajectory of an aircraft. The computation is performed based on the current state and future intent of the aircraft (aircraft intent and flight intent), an aircraft performance model, the airspace definition (adaptation data) and a forecast of the meteorological conditions.

1.7 Functional block Overview

The functional blocks defined in the TAD by P10.1.7 do not align 1-to-1 with the scope of the L3 projects in WP10. In WP10, there isn't a single TS per functional block because a TS is produced by each project. Therefore the scope of this TS is the ATC Trajectory Management requirements which cover several functional blocks of the ENR/APP ATC System.

founding members



Avenue de Cortenbergh 100 | B -1000 Bruxelles
www.sesarju.eu

13 of 97

1.8 Glossary of Terms

Note that further terms are defined for each of the functional capabilities (chapter 3).

Term	Definition
ATC Constraint	Constraints imposed by ATC that may restrict the aircraft from following its user preferred profile, e.g., performing "Free Flight".
ATC Clearance	Authorization for an aircraft to proceed under conditions specified by an air traffic control unit.
ATC Instruction	Directives issued by air traffic control for the purpose of requiring a pilot to take a specific action.
ATC Information	Information provided by ATC to the flight crew, for example which STAR to expect.
Current (C_ATSU) ATSU	The ATSU that can exchange ATC communications messages with an aircraft
Downstream (D_ATSU) ATSU	An ATSU planned to be crossed by the flight and downstream of the C_ATSU.
Flight Intent	Flight intent (FI) generalizes the concept of flight plan (a flight plan can be seen as an instance of flight intent) and includes, in addition to the strategic information typically included in a flight plan, such as departure and arrival airports, intended route, preferred cruise flight level and speed, estimated time of arrival (ETA), etc., other information of a more tactical and dynamic nature, such as intended SID and STAR, updates to the ETA, amendments to route/speed/level, descriptions of instructions issued by the controller, etc. (From [7], AIDL Final Report).
I4D Flight	A flight capable of time-based operations. The flight is logged on to the ground system and CPDLC is connected.
Planned Trajectory	The planned trajectory represents a medium-term view of the trajectory of a flight through an area of interest. In this context, the term "medium-term" is often considered to extend from a number of hours before the flight takes place, up to one or two minutes from the current time. The planned trajectory is built initially in accordance with the flight intent, as described by the flight plan, and constrained by ATC procedures. Once the flight is active, the trajectory can be modified by planning constraints, and by the integration of flight progress. The planned trajectory is the basis upon which flight data is nominally distributed to the sectors traversed by a flight, coordination is performed between sectors and between ATC units, sector planning and medium-term conflict detection are performed, and upon-which deviation from the planned intent is monitored.
RBT	Reference Business Trajectory. It is the trajectory that the Airspace User agrees to fly and that the ANSP and Airport agree to facilitate.
System	In this document "the system" refers to the ENR/APP ATC System as defined

founding members



Avenue de Cortenbergh 100 | B -1000 Bruxelles
www.sesarju.eu

14 of 97

Term	Definition
	by the ADD [1].

1.9 Acronyms and Terminology

Acronym	Definition
ADD	Aircraft Derived Data
ADEP	Airport of Departure
ADS-C	Automatic Dependant Surveillance Contract
AFL	Actual Flight Level
AGDC	Air-Ground Data Communication
AGDS	Air-Ground Datalink Services
AIDL	Aircraft Intent Description Language
AMAN	Arrival Management
ANSP	Air Navigation Service Provider
AO	Aircraft Operator
AOR	Area of Responsibility
APP	Approach
ARES	Airspace Reservation
ATC	Air Traffic Control
ATCO	Air Traffic Control Officer
ATM	Air Traffic Management
ATMS	Air Traffic Management System
ATS	Air Traffic Services
ATSU	Air Traffic System Unit
AU	Airspace User
BADA	Base of Aircraft Data
C&T	Coordination & Transfer

founding members



Avenue de Cortenbergh 100 | B -1000 Bruxelles
www.sesarju.eu

15 of 97

Acronym	Definition
CAS	Calibrated Air Speed
CDA	Continuous Descent Approach
CDM	Collaborative Decision Making
CDR	Conditional Routes
CFL	Cleared Flight Level
CHMI	Controller Human Machine Interface Management
CONF	Conflict Management
CORR	Correlation Management
CPDLC	Controller Pilot Data Link Communication
CTA	Controlled Time of Arrival
CTO	Controlled Time Over
CWP	Controller Working Position
DAP	Downlink Aircraft Parameters
DOD	Detailed Operational Description
EAT	Estimated Approach Time
EFPL	Extended Flight Plan
ENB	Enabler
ENR	En-Route
EPP	Extended Projected Profile
ETA	Estimated Time of Arrival
ETO	Estimated Time Over
ETOT	Estimated Take Off Time
FAF	Final Approach Fix
FB	Functional Block
FDMP	Flight Data Manager Publisher
FI	Flight Intent

founding members



Avenue de Cortenbergh 100 | B -1000 Bruxelles
www.sesarju.eu

16 of 97

Acronym	Definition
FL	Flight Level
FMS	Flight Management System
FO	Flight Object
FOC	Flight Operations Centre
FPL	Flight Plan
FPLD	Flight Plan - Lifecycle Mgt - Data Distribution
FPM	Flight Path Monitoring
FT	Feet
FUA	Flexible Use of Airspace
GGDC	Legacy Ground-Ground Data Communication
GGIOP	Ground-Ground IOP Management
HMI	Human Machine Interface
IAF	Initial Approach Fix
IAP	Instrument Approach Procedure
IAS	Indicated Air Speed
ICAO	International Civil Aviation Organization
i4D	Initial 4D trajectory
IFPS	Initial Flight Plan Provider System
IFR	Instrument Flight Rule
INTEROP	Interoperability
IOP	Interoperability
IRS	Interface Requirements Specification
ISA	International Standard Atmosphere
ISO	International Standards Organization
LTCM	Local Traffic Complexity Management
MONA	Monitoring Aids

founding members



Avenue de Cortenbergh 100 | B -1000 Bruxelles
www.sesarju.eu

17 of 97

Acronym	Definition
MSL	Mean Sea Level
MTCD	Medium-Term Conflict Detection
NFL	Entry Flight Level
NM	Network Manager
OFA	Operational Focus Area
OLDI	On-line Data Interchange
OPS	Operational
OPSUP	Operational Supervision
OSED	Operational Service and Environment Definition
PBN	Performance Based Navigation
PC	Planning Controller
PV	Performance Verification
RBT	Reference Business Trajectory
REQ	Requirement
RPA	Remote Piloted Aircraft
RTA	Required Time of Arrival
SBT	Shared Business Trajectory
SDM	Supplementary Data Message
SESAR	Single European Sky ATM Research Programme
SFPL	System Flight Plan
SID	Standard Instrument Departure
SJU	SESAR Joint Undertaking
SNET	Safety Nets
SP	System Parameter
SPR	Safety and Performance Requirements
SSR	Surveillance Secondary Radar

founding members



Avenue de Cortenbergh 100 | B -1000 Bruxelles
www.sesarju.eu

18 of 97

Acronym	Definition
STAR	Standard Terminal Arrival Route
SUPP	Support
SUR	Surveillance
SWIM	System Wide Information Management
SWP	Sub Work Package
TAD	Technical Architecture Description
TAS	True Air Speed
TBO	Time Based Operations
TC	Tactical controller
TM	Trajectory Management
TMA	Terminal Manoeuvring Area
TMF	Trajectory Management Framework
TOD	Top Of Descent
TOW	Take-Off Weight
TP	Trajectory Prediction
TRACT	TRajjectory Adjustment through Constraint of Time
TS	Technical Specification
TSA	Temporary Segregated Area
TTL / TTG	Time to lose / Time to gain
VFR	Visual Flight Rules
VPS	Variable Parameter System
WILCO	Will Comply
WOC	Wing Operations Center
WP	Work Package

2 General Functional block Description

2.1 Context

The following figure gives an overview of the role of the different functional blocks within the i4D Scenario. More details on the overall En-Route/Approach system architecture are given in the deliverable WP10.01.07-D115-Technical Architecture Description.

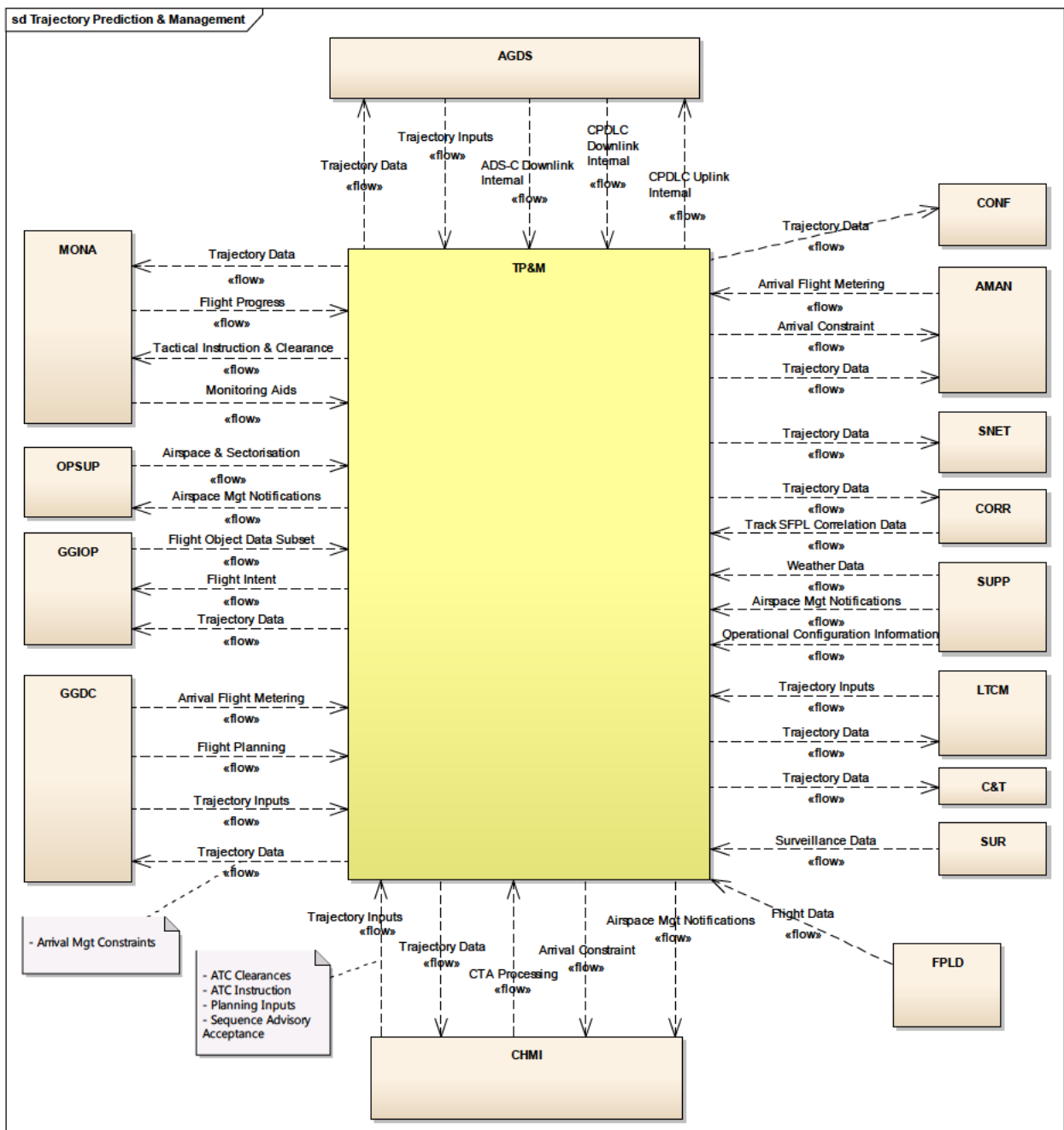

Figure 2 functional breakdown for TP&M

founding members



Avenue de Cortenbergh 100 | B -1000 Bruxelles
 www.sesarju.eu

The flight plan change is not necessarily triggered by the Air-Ground Trajectory Inconsistency in case the inconsistency is due to the ground system”.

2.2 Functional block Modes and States

N/A.

founding members



Avenue de Cortenbergh 100 | B -1000 Bruxelles
www.sesarju.eu

21 of 97

2.3 Major Functional block Capabilities

The requirements are organised around the following functional capabilities (of the system):

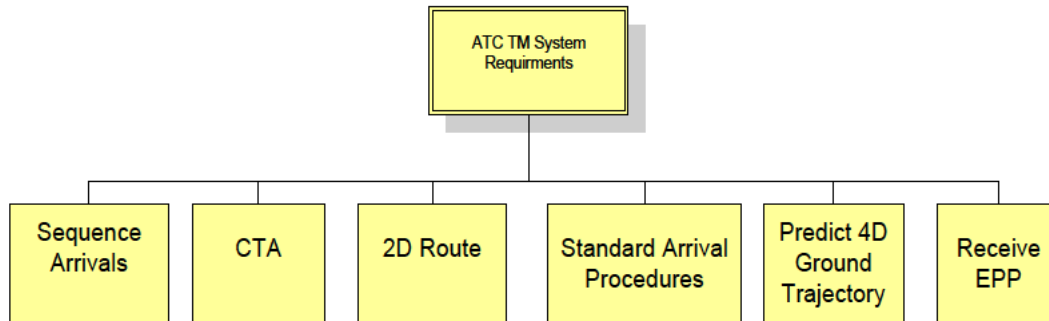

Figure 3 TM Requirements Breakdown

2.4 User Characteristics

There are several users (typically controllers) supported by the ATC ENR/APP system with different roles and responsibilities. Listed below are some of these roles and some of their associated tasks:

- **Planning Controller:** Coordinate an entry flight, check the planned trajectory of a flight intending to enter the sector for potential separation risk with flights already in the sector or other inbound flights. Take into account pilot intent and constraints and reflect the changes in the planned trajectory. Coordinate sector exit checking the exit conditions for potential separation risk in the exit boundary.
- **Executive Controller:** Clear the optimised planned trajectory with the Flight Crew, monitor the separation of the flights and transfer the assumed flight to the appropriate controller when no pending actions exist for that flight in the sector. This controller is responsible for “implementing” revisions of planned trajectory (issuing an ATC clearance or instruction), e.g. a CTA.
- **Sequence Manager / Supervisor :** Manage of the sequence to runway, generally with the support of an automated arrival management (AMAN) tool

founding members



Avenue de Cortenbergh 100 | B -1000 Bruxelles
www.sesarju.eu

23 of 97

2.5 Operational Scenarios

The Trajectory Management Scenario is split into the following sub scenarios:

- 1 **En Route preparations for reception of an inbound flight:** This covers the operations that can happen, prior to a flight's entry into the subject ATSU's airspace. It covers the period after creation of the iRBT/iRMT and up to the point where flights are about to be coordinated into the En-route sectors concerned. This includes Trajectory Management support for the various events which can occur during this preparatory period, such as Complexity Management requested RBT revisions.
- 2 **Operations & Transfer of flights between ATC units:** This covers the trajectory operations that can occur, while flights are in the process of being transferred and coordinated, into and out of the En-route sectors and during traversal across the sector airspace. This includes Trajectory Management support for the various events which can occur during this period, such as Separation Management requested RBT revisions. It excludes the cases which follow and which are described separately as special subjects in more detail:
- 3 **Trajectory Management Support for Application of Arrival Management time constraints:** This covers the Trajectory Management services used during the execution phase application of a CTA as a result of Arrival Management extended into En-route airspace. The objective is to expose the SESAR Step 1 operational circumstances and events that can trigger Trajectory Management related services associated with the agreement and application of a CTA constraint. It is not a complete description of what is needed for the Arrival Management concepts or operations: the scenario only covers the TM-related part of AMAN; for further details on that refer to the SWP 05.02 DOD Step 1.
- 4 **Passage of flights through an ARES:** This covers Trajectory Management related support for nominal and non-nominal passage of flights through an ARES in accordance with civil/military advanced Flexible Use of Airspace (FUA) agreements.
- 5 **Step 1 Military Operations:** This covers the Trajectory Management related services associated with making and using an ARES with an assigned activation period.
- 6 **Oceanic Procedures:** This covers the Trajectory Management related services associated with transit of flights to, across and from the Oceanic regions.

This specification supports the operational improvements (OIs) of the following operational focus areas (OFAs).

2.5.1 Trajectory Management Framework and System Interoperability with air and ground data sharing (ENB 03.01.01 TMF)

(Scenario 1,2,3)

One of the key concepts in SESAR is to enable a switch from Airspace Based Operations to Trajectory Based Operations in the Air Traffic Management (ATM) domain, by ensuring that airborne and ground systems share the same view of the aircraft trajectory and that the flight is executed in accordance with this reference

Therefore each ATM system will no longer predict its own view of the trajectory in an almost stand-alone mode but interoperability with other systems will be needed in order to ensure a common view for the flight and to manage the trajectory on a wider scope than previously. The Trajectory Management (TM) function becomes a transverse function of the European ATM system (E-ATMS) and of which one element is the ground ATC system.

TM can be seen as a set of processes/services that allow the computation, creation, revision and update of any flight trajectory and its distribution to the relevant actors.

The process of TM starts off-line with the building of the SBT/SMT and continues up to the end of the flight when the trajectories flown and computed by air and ground systems are stored for further analysis.

As the ATM system needs to consider any type of flight, the TM process needs to be able to support 4D equipped a/c, non-equipped a/c, military flights and in the future Remote Piloted Aircraft (RPA).

During the execution of the flight, various actors may interact with the trajectory, including the Flight Operations Centre (FOC/WOC) and Wing Operations Centre (WOC), amongst others. These actors need to change specific flight preferences for ATM automation tools, where a revision of the trajectory of one or more aircraft is required in order to satisfy ATM constraints. The requirement to revise a specific trajectory usually arises from the controller but also, less frequently, from the aircraft flight deck.

Trajectory Management OFA is number ENB 03.01.01.

founding members



Avenue de Cortenbergh 100 | B -1000 Bruxelles
www.sesarju.eu

25 of 97

2.5.2 Enhanced Arrival & Departure Management in TMA and En Route (OFA 04.01.02)

(Scenario 3)

Computed and predicted single Controlled Time of Arrival (CTA) for En-route and TMA environments, with associated airborne technology e.g. Flight Management System (FMS) and the appropriate ground-based system support by using initial 4D capability, allows to improve arrival management and sequence building, especially for medium and high density operations and including military operations.

This objective is to make use of advanced airborne technologies (e.g. advanced flight management capability for self-management to a time constraint already exist in many aircraft but they are not fully exploited by the ground systems), and integrate the various airborne technologies in the end-to-end ATM system.

The use of aircraft trajectory intent in relation to its flight management [time/navigation] should be exploited by ground systems.

Enhanced Arrival & Departure Management in TMA and En Route OFA is number 04.01.02.

founding members



Avenue de Cortenbergh 100 | B -1000 Bruxelles
www.sesarju.eu

26 of 97

2.6 Functional

2.6.1 Functional decomposition

TP&M Trajectory Prediction & Management

The Trajectory Prediction and Management functional block (Fig. 2) itself creates the planned flight trajectory according to the flight intent (planned route and tactical constraints), aircraft intent (where extracted from downlinked data) and predefined environment data and constraints.

TP&M also allows the creation of all the other types of contextual trajectories such as tactical, deviation, what-if, what-else...

Where interoperability is supported through the use of the flight object, it is assumed that the environment data is sufficient to compute the trajectory over the complete IOP area and trajectories are thus synchronized between the concerned actors within defined tolerances.

More specifically, TP&M:

- Manages local Flight Intents and integrates the various relative requested revisions whatever the origin (local system request or synchronisation with external stakeholders)
- Maintains an up-to-date trajectory in regards to the flight progress available from MONA and track information from surveillance
- Improves the accuracy of the ground trajectories that it manages using downlink airborne trajectories and aircraft intent (e.g. through Extended Projected Profile data).
- Identify the intersections of the trajectories with any defined airspace when required. Those intersections are assumed to be provided in the usual Trajectory Data flows.

2.6.1.1 Functional Breakdown of TP&M

Capability: Sequence Arrivals

This capability encompasses sequencing of inbound flights for arrival at destination airport using estimates over entry points or metering fixes, calculating controlled times to be provided to pilots or airborne systems via next upstream center or directly.

The description is found in the chapter §3.1.1, however no requirements are defined there, since no “Sequence Arrival Capability” requirements impact TP&M TS. All requirements referencing “Sequence Arrival Capability” are already provided by AMAN TS [ref. 22].

Capability: Issue/Cancel CTA

This capability encompasses requirements which deal with delivering chain to the aircraft the Controlled Time of Arrival at a certain Metering Fix. It includes all actions until confirmation (or rejection/unable) from the pilot and controlling the flight progress (real time check of feasibility). In case of rejection by the pilot it includes also cancellation of CTA.

The requirements are listed in the chapter §3.1.2

Capability: 2-D Route

founding members



Avenue de Cortenbergh 100 | B -1000 Bruxelles
www.sesarju.eu

This capability encompasses requirements which deal with horizontal (2D) route management including modifications as a collaborative process between Pilot and Controller and vice versa. Especially it deals with route modifications (by adding/removing waypoint fixes), which affect CTA metering fixes when CTA/RTA is active. With the help of downlinked route (EPP) consistency monitoring is enabled (with warnings).

The requirements are listed in the chapter §3.1.3

Capability: STandard ARrival Route

This capability encompasses in the present issue of TS only one requirement for sharing the STAR allocation.

The requirement is listed in the chapter §3.1.4

Capability: Predict 4-D Ground Trajectory

This capability is the core of this TS and encompasses a big set of requirements which deal with the literal i4D elements that is 2-D route plus Altitude plus Time Over determination as Trajectory computation process. This includes prediction of a 3D trajectory(ies) out of route and constraints, applying CTA making it a 4D trajectory. With ADD (aircraft derived data) and FOC/WOC (Flight operations center / Wing Operation Centre) information the 4D trajectory can be refined.

The requirements are listed in the chapter §3.1.5

Capability: Receive EPP

This capability should encompass requirements which deal with the pure reception of EPP as an own FB. The use of EPP data is described in the above Capabilities, where accordingly..

..the requirements are distributed in the chapters §3.1.2 and 3.1.3 and 3.1.5.

2.6.1.2 Interactions of TP&M FB with other FB

Here is the list of FB's that interact with TP&M within an ATM System:

Controller Human Machine Interaction (CHMI)

The CHMI receives from TP&M:

- Arrival Constraint
- Airspace Management Notifications
- Trajectory Data

This information is used to data presentation to – and interaction with – the controller (covering planner and tactical [executive] roles in En-route and TMA.

Ground-Ground Datalink Communications (GGDC)

GGDC uses the trajectory data from TP&M. It translates data between internal interfaces and the standard protocols in use with the external systems.

Ground-Ground IOP Management (GGIOP)

founding members



Avenue de Cortenbergh 100 | B -1000 Bruxelles
www.sesarju.eu

The “Ground-Ground IOP Management” and “Legacy Ground-Ground Datalink Communication” functional blocks use the SWIM infrastructure and OLDI in order to communicate with other ENR/APP ATC Systems. They contribute to the TM function by exchanging the Flight Intent and its modifications between different ENR/APP ATC systems.

GGIOP uses the information received from TP&M (Trajectory Data and Flight Intent) for the updates of the flight objects (translation of the local SFPL into the FO, FO updates). Subsequently GGIOP will be in charge of the management, dissemination and synchronization of flight objects with other ATSU's in the IOP area.

Operational Supervision (OPSUP)

The Airspace Management Notifications received will be presented to Operational Supervisor. Examples of these notifications could be aerodrome group configuration, runway rate, airspace data (holding area, general approval volume), frequency plan, CDR and TSA status, SSR code allotment plan, Holding area...

Monitoring Aids (MONA)

Trajectory Data and Tactical Instruction and Clearance are received from TP&M.

Trajectory Data is used to detect if a controlled aircraft deviates from its planned trajectory, notifying deviation warnings to the concerned sectors.

Tactical Instruction & Clearance is used to detect if a controlled aircraft deviates from the issued clearance/instruction and notifies the current executive controller.

Air-Ground Datalink Services (AGDS)

The “Air-Ground Datalink Services” functional block uses the air-ground communication infrastructure (through Air-Ground Datalink Communication functional block) in order to communicate with the aircraft. AGDS contributes to the TM function by using the air-ground communications infrastructure (through AGDC) to uplink the ATC Instructions, ATC Clearances and ATC Information to the aircraft in order to synchronise air and ground views of the Flight Intent. AGDS provides the operational reply received from the aircraft to these uplinks (e.g. WILCO, UNABLE, ROGER).

CPDLC Uplink Internal information is used to uplink contract requests to the aircraft.

Trajectory Data is used for consistency checks between downlinked data and ground data.

Conflict Management (CONF)

Trajectory Data is used for Medium-Term and Near-Term detection of conflicts between flights and between flights and restricted airspace, for planner and tactical controller, by analysing flight trajectories.

Arrival Management (AMAN)

Arrival Constraint and Trajectory Data are used for determining an optimal arrival sequence at designated aerodromes and providing associated advisories such as time to lose/gain and Controlled Time of Arrival based on downlinked ETA min/max at the metering point. The sequence and advisories are distributed to the Controller Working Positions and to external clients.

Safety Nets (SNET)

founding members



Avenue de Cortenbergh 100 | B -1000 Bruxelles
www.sesarju.eu

Alerts the ATC controllers in case of short-term danger for an aircraft to infringe separation criteria with other aircraft or danger areas or in case the aircraft deviates from the nominal approach path.

Trajectory Data is received from TP&M and used for the above purpose.

Correlation Management (CORR)

CORR uses the Trajectory Data to correlate system tracks with flight data.

Support Functions (SUPP)

The Support Functions Functional Block does not affect directly the provision of ATM Services at operational time. For the TP&M it is of relevance for reception of meteorological data, airspace management notifications and some operational configuration data which the TP&M consumes.

Local Traffic Complexity Management (LTCM)

LTCM uses the Trajectory Data as input, among others, to calculate traffic complexity within predefined airspace volumes.

Coordination & Transfer (C&T)

C&T uses the input from TP&M for the management of coordination and transfer of flights between "internal" sectors and with external ATSUs.

Surveillance (SUR)

The surveillance functional block provides the TP&M obviously with surveillance data needed to check and fine tune the trajectory computations and management (e.g. in case of significant deviations). Surveillance data are: system tracks supplemented with flight data.

Flight Plan - Lifecycle Mgt - Data Distribution (FPLD)

This FB manages the system flight plans (SFPL) for IFR and VFR flights from creation until their deletion from their life cycle perspective (excluding any trajectory perspective which is within TP&M scope) and encompasses among others the following aspect:

- SFPLs are created and updated upon receipt of flight plans (including extended flight plans), air traffic flow and capacity restrictions, revisions from other ATC centres, or on manual input (including tactical control instructions) for flights that traverse the system's Area of Interest (Aoi).

The TP&M consumes the Flight Data received (also updates) from FPLD for initialisation of the Trajectory computations and its updates.

2.6.2 Functional analysis

For the functional analysis please refer to the P10.1.7 “Allocated Requirements and Models” deliverable.

This scenario covers the creation of the Flight Object by an ATSU when receiving an FPL or an EFPL message from the IFPS and no FO exist yet for this flight plan. This scenario is an intermediary development phase where NM/AM system does not provide yet the FO.

In this context, the first “FO enabled” ATSU receiving an FPL that traverse its AoRs or Aols is responsible for the creation of the FO and its distribution to the other concerned ATSU’s. This ATSU is the FDMP.

General Conditions

- ATSU is inside IOP Area.
- Flight is inside IOP Area, and the trajectory goes by the AoR of the ATSU.

Pre-Conditions

- The ATSU's AoR is the first one traversed by the Flight Plan (ATSU is FDMP).
- IFPS has received an FPL from the AO.

Post Conditions

- First release of the Flight Object is created.
- Flight Object is distributed.

founding members



Avenue de Cortenbergh 100 | B -1000 Bruxelles
www.sesarju.eu

31 of 97

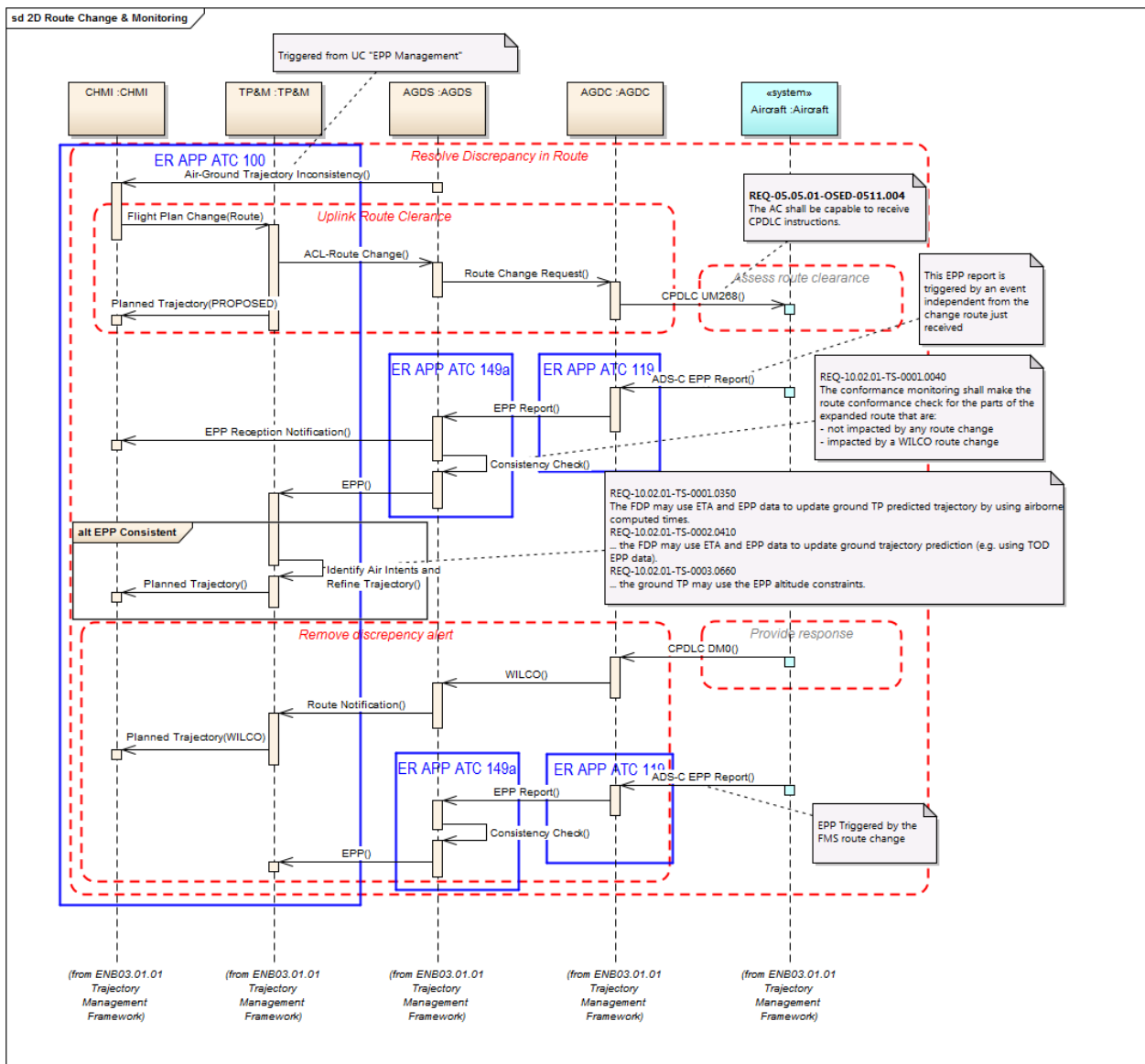

Figure 4 Functional View

2.7 Service View

This specification covers the following TM services:

- Flight Intent
- Trajectory
- FMS Trajectory
- Controller-Pilot Uplink
- ETA min/max

founding members



Avenue de Cortenbergh 100 | B -1000 Bruxelles
 www.sesarju.eu

3 Functional block Functional and non-Functional Requirements

With reference to the requirements status, in the document we use 3 different status:

- <in progress> if the requirement is defined but is not validated in any exercise
- <Validated> if the requirement is validated in almost one of the exercises related to P10.02.01
- <Deleted> if the project Team decided to eliminate the requirement from the list.

The exercises that validated the requirement of this project are:

- EXE-05.06.01-VP-477
- EXE-04.07.02-VP-501
- EXE-05.03-VP-805

3.1 Capabilities

3.1.1 Sequence Arrivals Capability

This capability allows sequencing flights arriving at a aerodrome by allocating an Estimated Approach Time (EAT) according to the position in the sequence and the amount of holding. In order to set an achievable EAT, the system may get from the aircraft a time window on the point (ETA min/max). If the system has an ADS-C connection with the flight, the ETA min/max can be supplied directly by the aircraft; otherwise the ETA min/max is requested to the controlling ATSU in order to make the ADS-C request. Where possible, the arrival management function will set an EAT within the ETA min/max window such that the EAT could be implemented by uplink of a CTA Instruction.

In addition to the EAT itself, the AMAN tool may provide advisories to the controller about how to meet the EAT, these can take the form of a Time To Lose or Gain, or a speed advisory. If the flight is i4D equipped, and the EAT falls within the ETA min/max window, the controller may choose to implement the EAT by issuing a CTA Instruction to the flight crew.

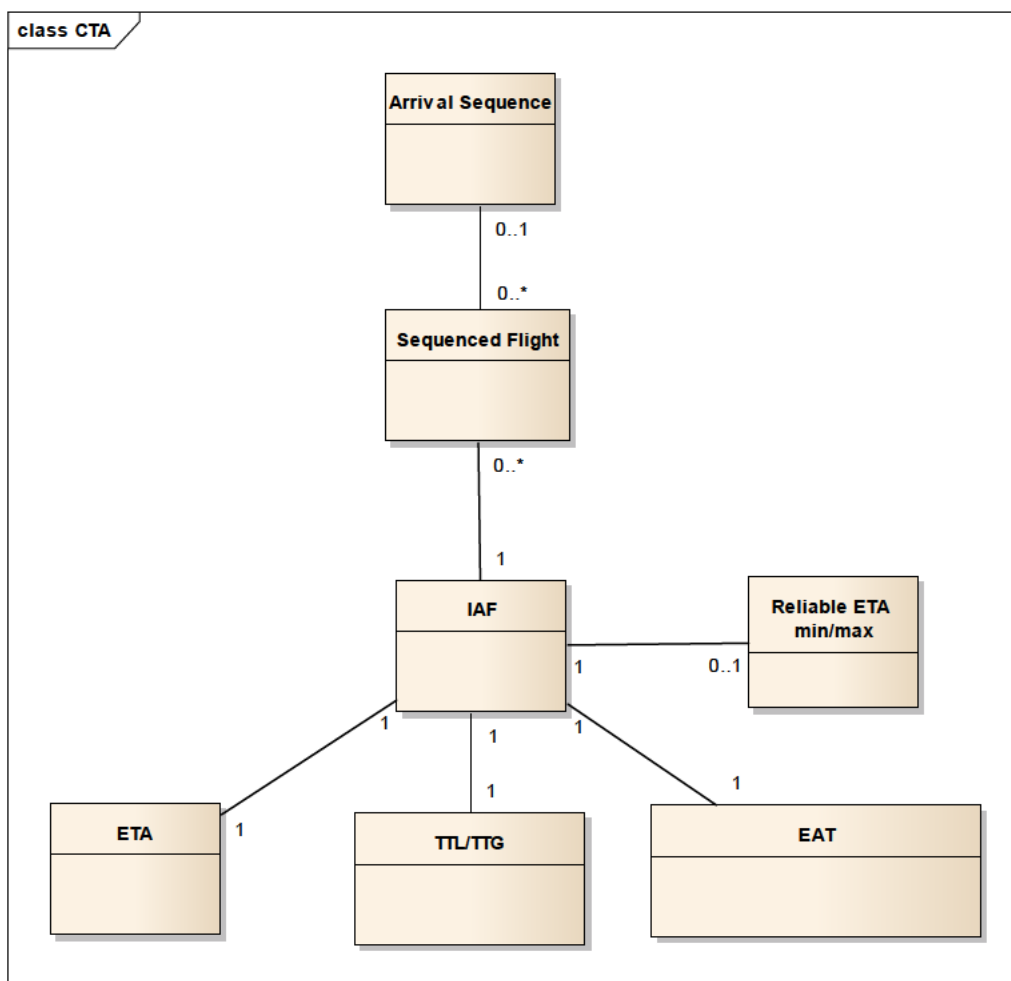

Figure 5 Arrival Sequence Domain Model

Entity	Description
Arrival Sequence	Defines the planned order that flights inbound to an arrival aerodrome will arrive at the metering points.
ETA	Estimated Time of Arrival. This is the time that the aircraft is predicted to arrive in case there was nothing in the way.
IAF	Intermediate Approach Fix. Point over which inbound aircraft are metered (sequenced).
Reliable ETA min/max	Reliable ETA Min/Max provided by the aircraft identifies a time window for the point question which is robust against possible known wind error, within which the aircraft can provide a known and guaranteed time accuracy and performance.
EAT	Estimated Approach Time. This is the target time of arrival designed to position the aircraft in the arrival sequence with minimal holding and to maximise landing rate. The controllers will endeavour to deliver the flights to the metering points at the target time by issuing speed instructions, vectoring, issuing CTA Instructions, or a combination of the above.

founding members



Avenue de Cortenbergh 100 | B -1000 Bruxelles
www.sesarju.eu

Entity	Description
Sequenced Flight	Define a flight just included in the Arrival Sequence
TTL/TTG	The time to lose or gain in order to achieve the EAT.

No "Sequence Arrival Capability" requirements impact TP&M TS.
All requirements referencing "Sequence Arrival Capability" are already provided by AMAN TS.

founding members



Avenue de Cortenbergh 100 | B -1000 Bruxelles
www.sesarju.eu

35 of 97

3.1.2 Issue/Cancel CTA Capability

Once the EAT has been automatically determined by the Arrival Management Function (Approach unit), it is the responsibility of the upstream controlling ATSU to help deliver the flight to the metering fix as close to the EAT as possible.

For i4D equipped aircraft a CTA Instruction may be uplinked to the aircraft by the current executive controller using datalink (The CTA Instruction may also be given by voice). Only 1 CTA can be issued per flight at any given time.

Note that for a non i4D equipped aircraft may be issued a CTA (mainly by voice, if a granularity by seconds is demanded.).

founding members



Avenue de Cortenbergh 100 | B -1000 Bruxelles
www.sesarju.eu

36 of 97

The diagram below shows the typical scenario in which an arrival sequence is computed by the arrival management function in the approach ATSU. According to the desired arrival sequence, the ETA and the amount of holding, a EAT is determined for each aircraft within the AMAN horizon.

The ETA min/max from the aircraft allows the AMAN to try to generate an EAT that is achievable by speed control. If the EAT is within the ETA min/max window, the executive controller at the C-ATSU may decide that the EAT can be best delegated to the flight crew by uplink of a CTA Instruction to the aircraft.

The C-ATSU shares the CTA Instruction issued by executive controller to the downstream ATSU such that when coordination and transfer of control occurs the receiving controller is aware the flight is flying to a CTA. (Note that for non-i4D equipped aircraft, or for EAT outside the ETA min/max window, the C-ATSU may absorb the delay at the IAF by issuing a speed instruction or vectoring the aircraft or as a CTA).

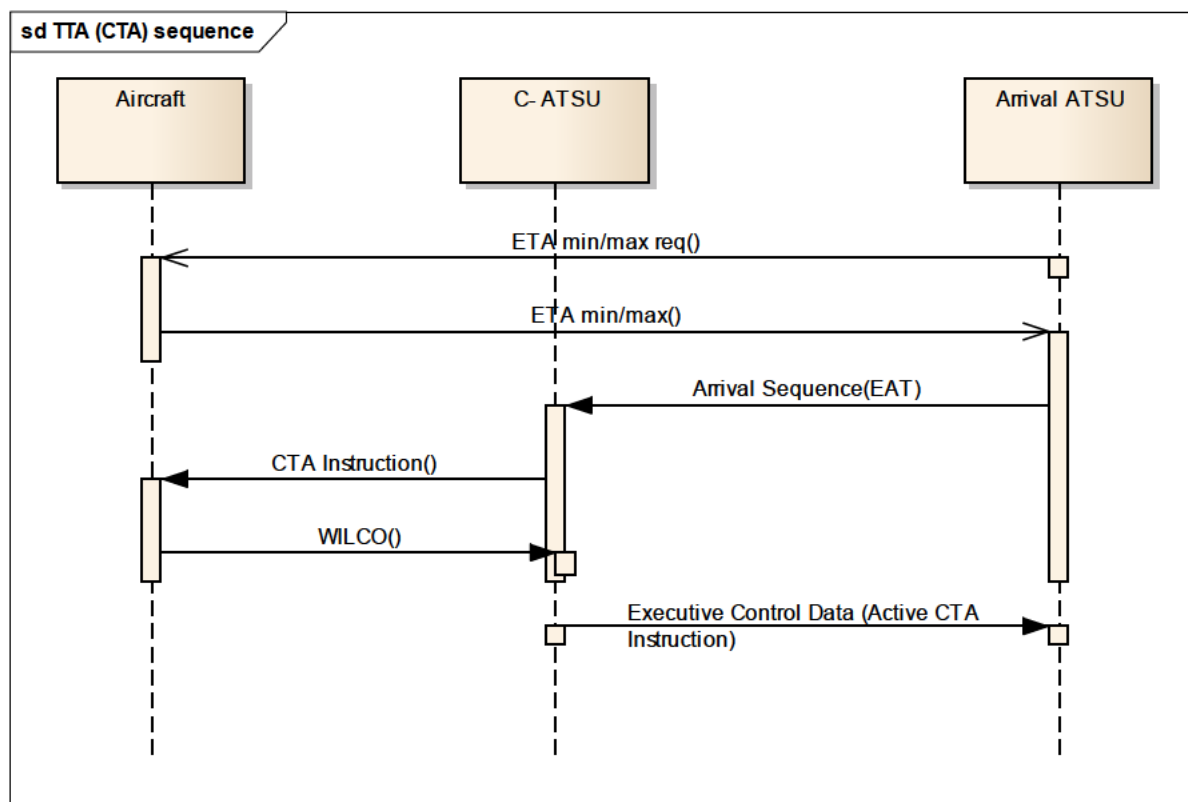

Figure 6: EAT implemented by CTA Allocation and Uplink

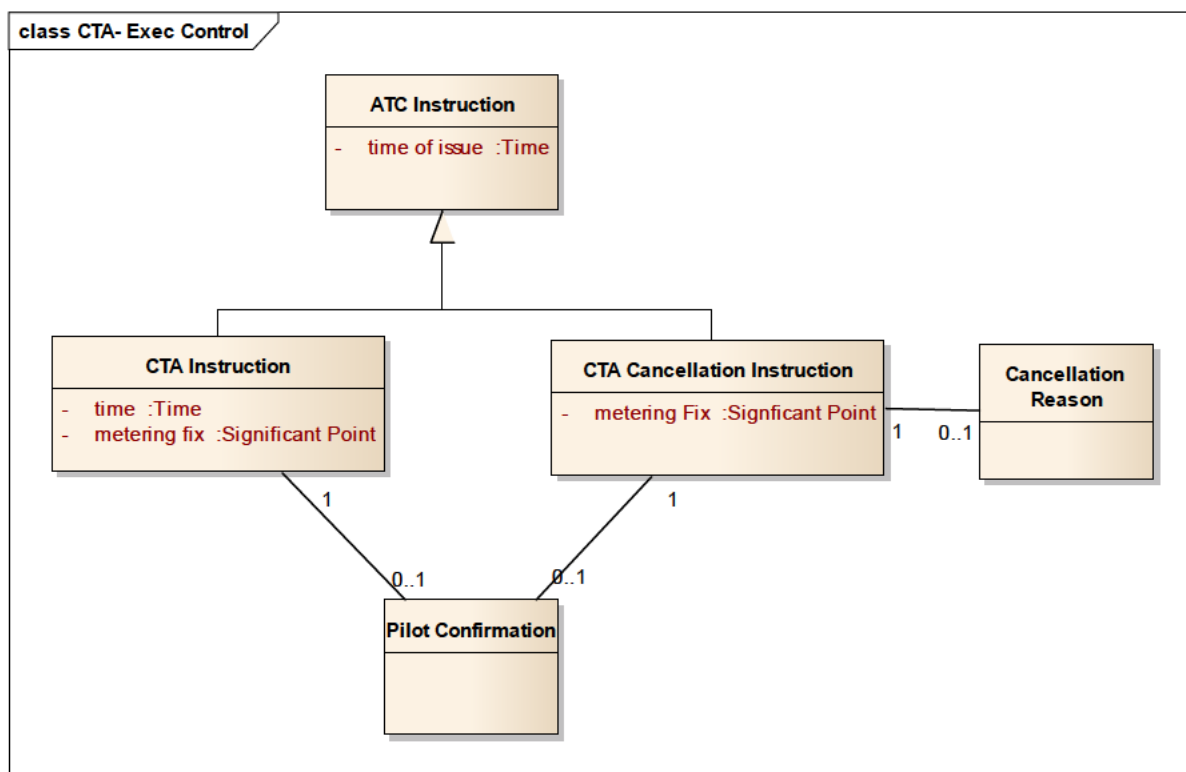

Figure 7 CTA Domain Model

Entity	Description
ATC Instruction	Directives issued by air traffic control for the purpose of requiring a pilot to take a specific action [ICAO 4444].
CTA Instruction	Controlled Time of Arrival Instruction. An ATC Instruction requiring the aircraft to arrive at a particular point at a given time.
CTA Cancellation Instruction	An ATC Instruction to cancel a previously issued CTA Instruction.
Pilot Confirmation	The pilot's response (WILCO or UNABLE) to a controller's ATC Clearance or ATC Instruction.
Cancellation Reason	An reason for a CTA cancellation, e.g. the controller has rejected the uplink task associated to a specific CTA Proposal.

3.1.2.1 Issue CTA Instruction

[REQ]

Identifier	REQ-10.02.01-TS-0001.0010
Requirement	For an i4D flight, the system HMI shall indicate to the executive controller that a CTA Instruction is pending uplink if <ul style="list-style-type: none"> EAT inside the ETA min/max window No air-ground route discrepancy is detected The metering fix on which the EAT applies is in the cleared route
Title	Identification of CTA capable flight.
Status	<Validated>
Rationale	I4D operations (CTA uplink) can be started by C-ATSU only for an i4d-capable flight with which the ADS-C contract has been established. Once logged-on the availability of i4D capability is known.
Category	<Functional><HMI>
Verification Method	<Test>
Validation Method	

[REQ Trace]

Relationship	Linked Element Type	Identifier	Compliance
<ALLOCATED_TO>	<Functional block>	Air-Ground Datalink Services (AGDS)	N/A
<ALLOCATED_TO>	<Functional block>	Controller Human Machine Interaction Management	N/A
<ALLOCATED_TO>	<Functional block>	Trajectory Prediction & Mgt (TP&M)	N/A
<SATISFIES>	<Enabler>	ER APP ATC 149	<Full>
<SATISFIES>	<ATMS Requirement>	REQ-05.06.01-OSED-SG05.0300	<Full>
<SATISFIES>	<ATMS Requirement>	REQ-05.06.01-Step 1SPR IT3-SAF1.0004	<Full>
<SATISFIES>	<ATMS Requirement>	REQ-05.06.01-Step 1SPR IT3-SAF1.0042	<Full>
<SATISFIES>	<ATMS Requirement>	REQ-04.05.00-OSED-F080-0040	<Full>

[REQ]

Identifier	REQ-10.02.01-TS-0005.0200
Requirement	The system shall display on CWP the ETA min-max provided by an aircraft before uplinking the CTA.
Title	ETA min-max on CWP
Status	<Validated>
Rationale	The ETA min-max should be available to the ATCO in order to allow ATCO being aware the CTA actually lies within ETA min-max window. The ETA min-max should be available to the ATCO in order to check that the CTA actually lies within ETA min-max window.
Category	<Functional><HMI>
Verification Method	<Test>
Validation Method	

[REQ Trace]

Relationship	Linked Element Type	Identifier	Compliance
<ALLOCATED_TO>	<Functional block>	Controller Human Machine Interaction Management	N/A
<ALLOCATED_TO>	<Functional block>	Air-Ground Datalink Services (AGDS)	N/A
<SATISFIES>	<Enabler>	APP ATC 148	<Full>
<SATISFIES>	<ATMS Requirement>	REQ-05.06.01-Step 1SPR IT3-SAF1.0071	<Full>
<SATISFIES>	<ATMS Requirement>	REQ-05.06.01-Step 1SPR IT3-PRF1.0004	<Full>
<SATISFIES>	<ATMS Requirement>	REQ-05.06.01-Step 1SPR IT3-PRF1.0005	<Full>

founding members



Avenue de Cortenbergh 100 | B -1000 Bruxelles
www.sesarju.eu

39 of 97

founding members



Avenue de Cortenbergh 100 | B -1000 Bruxelles
www.sesarju.eu

[REQ]

Identifier	REQ-10.02.01-TS-0005.0201
Requirement	The system shall not allow to uplink a CTA with a time constraint outside the ETA min-max window.
Title	System check CTA in ETA min/max window ETA min-max on CWP
Status	<Validated>
Rationale	For i4D aircraft, ground computed constraints shall only be proposed as a CTA when the CTA lies within the received ETA min-max Interval. The ETA min-max should be available to the ATCO in order to check that the CTA actually lies within ETA min-max window.
Category	<Functional>
Verification Method	<Test>
Validation Method	

[REQ Trace]

Relationship	Linked Element Type	Identifier	Compliance
<ALLOCATED_TO>	<Functional block>	Trajectory Prediction & Mgt (TP&M)	N/A
<ALLOCATED_TO>	<Functional block>	Air-Ground Datalink Services (AGDS)	N/A
<SATISFIES>	<Enabler>	APP ATC 148	<Full>
<SATISFIES>	<ATMS Requirement>	REQ-05.06.01-Step 1SPR IT3-SAF1.0071	<Full>
<SATISFIES>	<ATMS Requirement>	REQ-05.06.01-Step 1SPR IT3-PRF1.0004	<Full>
<SATISFIES>	<ATMS Requirement>	REQ-05.06.01-Step 1SPR IT3-PRF1.0005	<Full>

[REQ]

Identifier	REQ-10.02.01-TS-0001.0130
Requirement	For an i4D flight with a pending CTA, the system shall allow the executive controller currently in control of a flight to issue a CTA Instruction only if there is no 2D route discrepancy.
Title	Instruct CTAETA min-max on CWP
Status	<Validated>
Rationale	The CTA uplink is not automatic but is explicitly performed by the current executive controller (the CTA may also be given to the pilot by voice).The ETA min-max should be available to the ATCO in order to check that the CTA actually lies within ETA min-max window.
Category	<Functional>
Verification Method	<Test>
Validation Method	

[REQ Trace]

Relationship	Linked Element Type	Identifier	Compliance
<ALLOCATED_TO>	<Functional block>	Air-Ground Datalink Services (AGDS)	N/A
<ALLOCATED_TO>	<Functional block>	Trajectory Prediction & Mgt (TP&M)	N/A
<SATISFIES>	<Enabler>	APP ATC 148	<Full>
<SATISFIES>	<ATMS Requirement>	REQ-05.06.01-OSED-SG06.0200	<Full>
<SATISFIES>	<ATMS Requirement>	REQ-05.06.01-Step 1SPR IT3-SAF1.0042	<Full>
<SATISFIES>	<ATMS Requirement>	REQ-05.06.01-Step 1SPR IT3-SAF1.0062	<Full>

[REQ]

Identifier	REQ-10.02.01-TS-0005.0210
Requirement	CTA instructions shall always be associated with a point in the cleared route.
Title	CTA in cleared routeETA min-max on CWP
Status	<Validated>
Rationale	The CTA point needs to be associated with a known point within the cleared route. The ETA min-max should be available to the ATCO in order to check

founding members



Avenue de Cortenbergh 100 | B -1000 Bruxelles
www.sesarju.eu

	that the CTA actually lies within ETA min-max window.
Category	<Functional>
Verification Method	<Test>
Validation Method	

[REQ Trace]

Relationship	Linked Element Type	Identifier	Compliance
<ALLOCATED TO>	<Functional block>	Trajectory Prediction & Mgt (TP&M)	N/A
<SATISFIES>	<Enabler>	APP ATC 148	<Full>
<SATISFIES>	<ATMS Requirement>	REQ-05.06.01-OSED-SG05.0200	<Full>
<SATISFIES>	<ATMS Requirement>	REQ-05.06.01-Step 1SPR IT3-SAF1.0039	<Full>
<SATISFIES>	<ATMS Requirement>	REQ-05.06.01-Step 1SPR IT3-SAF1.0044	<Full>
<SATISFIES>	<ATMS Requirement>	REQ-05.06.01-Step 1SPR IT3-SAF1.0045	<Full>

[REQ]

Identifier	REQ-10.02.01-TS-0001.0150
Requirement	The system shall allow a controller to record that a CTA Instruction has been given to the pilot by Voice.
Title	CTA to the pilot by VoiceETA min-max on CWP
Status	<Validated>
Rationale	The CTA may be given to the pilot by voice if the aircraft is not DL equipped or does not have a CPDLC connection. The ETA min-max should be available to the ATCO in order to check that the CTA actually lies within ETA min-max window.
Category	<Functional>
Verification Method	<Test>
Validation Method	

[REQ Trace]

Relationship	Linked Element Type	Identifier	Compliance
<ALLOCATED_TO>	<Functional block>	Controller Human Machine Interaction Management	N/A
<ALLOCATED_TO>	<Functional block>	Trajectory Prediction & Mgt (TP&M)	N/A
<SATISFIES>	<Enabler>	ER APP ATC 149	<Full>
<SATISFIES>	<ATMS Requirement>	REQ-05.06.01-Step 1SPR IT3-SAF1.0081	<Full>

[REQ]

Identifier	REQ-10.02.01-TS-0001.0205
Requirement	The system shall prevent the issuing of a CTA Instruction which specifies an arrival time within SP_TM0006 minutes of current time.
Title	Prevention of too soon CTA
Status	<In Progress>
Rationale	The aircraft/pilot needs time to react to the CTA.
Category	<Functional>
Verification Method	<Test>
Validation Method	

[REQ Trace]

Relationship	Linked Element Type	Identifier	Compliance
<ALLOCATED TO>	<Functional block>	Trajectory Prediction & Mgt (TP&M)	N/A
<SATISFIES>	<Enabler>	APP ATC 148	<Full>
<SATISFIES>	<ATMS Requirement>	REQ-05.05.01-OSED-0511.006pre	<Full>

founding members



Avenue de Cortenbergh 100 | B -1000 Bruxelles
www.sesarju.eu

42 of 97

3.1.2.2 Issue CTA Cancellation Instruction

[REQ]

Identifier	REQ-10.02.01-TS-0003.0210
Requirement	The system shall allow the current executive controller to manually cancel a CTA.
Title	CTA Cancellation Input
Status	<Validated>
Rationale	It must be possible to cancel a CTA if it is no longer applicable. The controller in the current controlling ATSU shall be able to use the HMI to uplink the appropriate pre-formatted CPDLC message to the aircraft to cancel the CTA
Category	<Functional><HMI>
Verification Method	<Test>
Validation Method	

[REQ Trace]

Relationship	Linked Element Type	Identifier	Compliance
<ALLOCATED_TO>	<Functional block>	Controller Human Machine Interaction Management	N/A
<ALLOCATED_TO>	<Functional block>	Trajectory Prediction & Mgt (TP&M)	N/A
<ALLOCATED_TO>	<Functional block>	Air-Ground Datalink Services (AGDS)	N/A
<SATISFIES>	<Enabler>	APP ATC 148	<Full>
<SATISFIES>	<ATMS Requirement>	REQ-05.06.01-OSED-SG08.0200	<Full>
<SATISFIES>	<ATMS Requirement>	REQ-05.06.01-Step 1SPR IT3-SAF1.0114	<Full>
<SATISFIES>	<ATMS Requirement>	REQ-04.05.00-OSED-F080-0130	<Full>

[REQ]

Identifier	REQ-10.02.01-TS-0005.0030
Requirement	If a flight is re-sequenced with a different EAT and a CTA has been issued, the system HMI shall indicate to the current executive controller that CTA cancellation is required.
Title	CTA cancellation due to re-sequencing
Status	<In Progress>
Rationale	AMAN optimises the arrival sequence. Even if the flight has entered the AMAN frozen zone it might be manually re-sequenced. AMAN optimises the arrival sequence. Even if the flight has entered the AMAN frozen zone it might be manually re-sequenced.
Category	<Functional><HMI>
Verification Method	<Test>
Validation Method	

[REQ Trace]

Relationship	Linked Element Type	Identifier	Compliance
<ALLOCATED_TO>	<Functional block>	Air-Ground Datalink Services (AGDS)	N/A
<ALLOCATED_TO>	<Functional block>	Controller Human Machine Interaction Management	N/A
<ALLOCATED_TO>	<Functional block>	Trajectory Prediction & Mgt (TP&M)	N/A
<SATISFIES>	<Enabler>	APP ATC 148	<Full>
<SATISFIES>	<ATMS Requirement>	REQ-05.06.01-OSED-SG07.0300	<Full>

founding members



Avenue de Cortenbergh 100 | B -1000 Bruxelles
www.sesarju.eu

3.1.2.3 Display CTA

The operational status of the CTA shown to the controller on the HMI is a function of the issued CTA Proposals and CTA Cancellations Instructions and Pilot Response (WILCO/UNABLE), as shown in Figure 8.

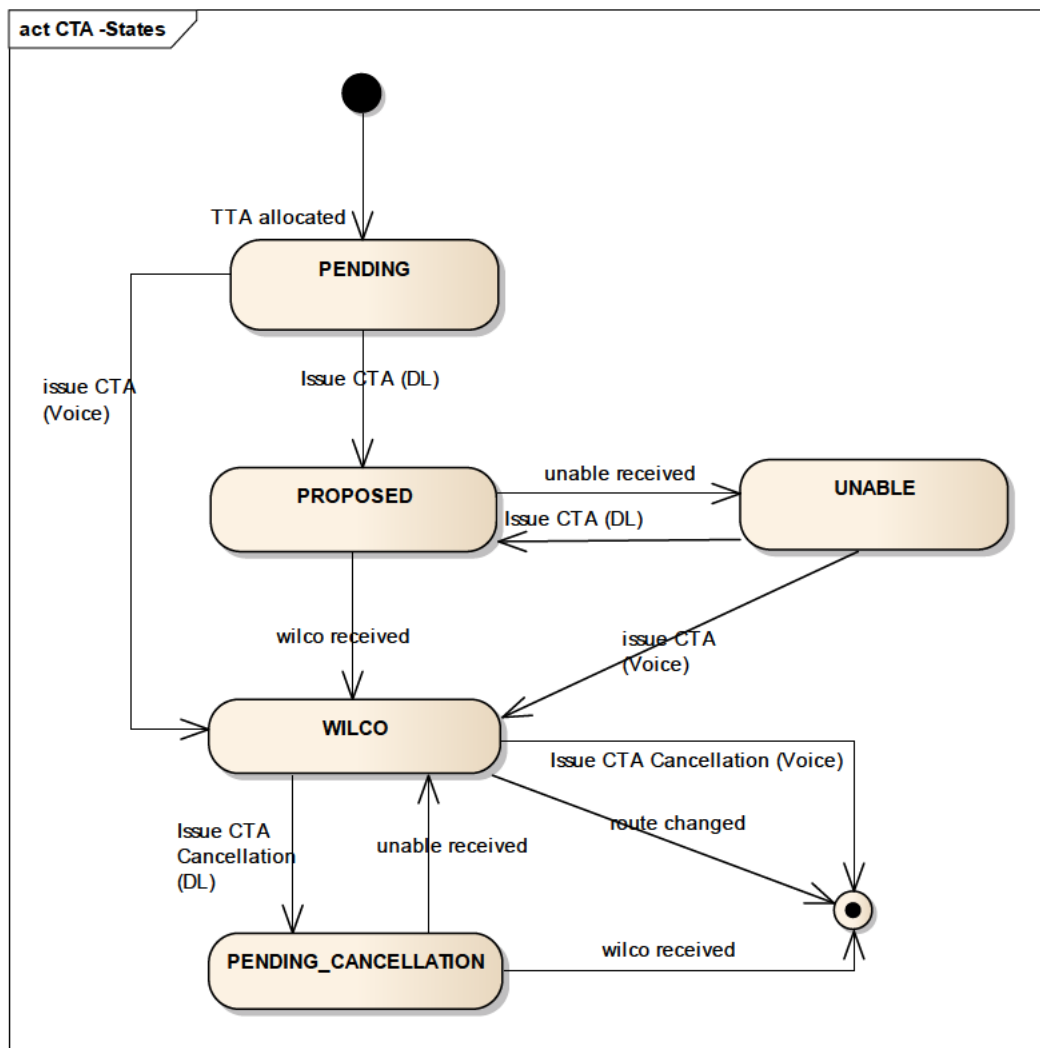

Figure 8 CTA Operational state chart (HMI)

founding members



Avenue de Cortenbergh 100 | B -1000 Bruxelles
 www.sesarju.eu

[REQ]

Identifier	REQ-10.02.01-TS-0003.0470
Requirement	The system shall display on the Controller HMI the CTA and its operational status, according to the Pilot Confirmation(s) to the issued CTA Proposal and CTA Cancellation instructions (Figure 8).
Title	Display CTA airborne status
Status	<Validated>
Rationale	The Controller needs to be aware of which flights are flying to a CTA so that conflicting speed or heading instructions can be avoided. Note that a CTA Instruction may be issued while waiting for the WILCO to a previous CTA Instruction. It is important that the system is able to associate the WILCO to the correct CTA Instruction. The way to show a CTA on the HMI (e.g. in the track label) is not in the scope of this specification.
Category	<Functional><HMI>
Verification Method	<Test>
Validation Method	

[REQ Trace]

Relationship	Linked Element Type	Identifier	Compliance
<ALLOCATED_TO>	<Functional block>	Air-Ground Datalink Services (AGDS)	N/A
<ALLOCATED_TO>	<Functional block>	Controller Human Machine Interaction Management	N/A
<ALLOCATED_TO>	<Functional block>	Trajectory Prediction & Mgt (TP&M)	N/A
<SATISFIES>	<Enabler>	APP ATC 148	<Full>
<SATISFIES>	<ATMS Requirement>	REQ-05.06.01-OSED-SG06.0500	<Full>
<SATISFIES>	<ATMS Requirement>	REQ-05.06.01-Step 1SPR IT3-SAF1.0066	<Full>
<SATISFIES>	<ATMS Requirement>	REQ-05.06.01-Step 1SPR IT3-SAF1.0067	<Full>
<SATISFIES>	<ATMS Requirement>	REQ-05.06.01-Step 1SPR IT3-SAF1.0068	<Full>
<SATISFIES>	<ATMS Requirement>	REQ-05.06.01-Step 1SPR IT3-SAF1.0076	<Full>
<SATISFIES>	<ATMS Requirement>	REQ-05.06.04-OSED-0028.0710	<Full>
<SATISFIES>	<ATMS Requirement>	REQ-05.06.04-OSED-0028.0720	<Full>
<SATISFIES>	<ATMS Requirement>	REQ-04.05.00-OSED-F080-0100	<Full>

[REQ]

Identifier	REQ-10.02.01-TS-0005.0220
Requirement	The system shall display on the Controller HMI the CTA and its operational status, according to the Upstream C-ATSU confirmation to the issued CTA Proposal and CTA Cancellation instructions.
Title	Display CTA ground status
Status	<Validated>
Rationale	The Approach Controller needs to be aware that the upstream executive controller agrees to uplink the CTA request to the Aircraft
Category	<Functional><HMI>
Verification Method	<Test>
Validation Method	

[REQ Trace]

Relationship	Linked Element Type	Identifier	Compliance
<ALLOCATED_TO>	<Functional block>	Air-Ground Datalink Services (AGDS)	N/A
<ALLOCATED_TO>	<Functional block>	Controller Human Machine Interaction Management	N/A
<ALLOCATED_TO>	<Functional block>	Trajectory Prediction & Mgt (TP&M)	N/A
<SATISFIES>	<Enabler>	APP ATC 148	<Full>
<SATISFIES>	<ATMS Requirement>	REQ-05.06.01-OSED-SG06.0600	<Full>
<SATISFIES>	<ATMS Requirement>	REQ-05.06.01-Step 1SPR IT3-SAF1.0066	<Full>
<SATISFIES>	<ATMS Requirement>	REQ-05.06.01-Step 1SPR IT3-SAF1.0067	<Full>
<SATISFIES>	<ATMS Requirement>	REQ-05.06.01-Step 1SPR IT3-SAF1.0075	<Full>
<SATISFIES>	<ATMS Requirement>	REQ-05.06.01-Step 1SPR IT3-SAF1.0076	<Full>
<SATISFIES>	<ATMS Requirement>	REQ-05.06.01-Step 1SPR IT3-SAF1.0116	<Full>

founding members



Avenue de Cortenbergh 100 | B -1000 Bruxelles
www.sesarju.eu

<SATISFIES>	<ATMS Requirement>	REQ-04.05.00-OSED-F080-0100	<Full>
-------------	--------------------	-----------------------------	--------

founding members



Avenue de Cortenbergh 100 | B -1000 Bruxelles
www.sesarju.eu

3.1.2.4 Share Executive CTA Instructions

[REQ]

Identifier	REQ-10.02.01-TS-0005.0040
Requirement	The system shall share with adjacent ATSUs: - last active CTA Instruction issued to a flight (i.e. for which a WILCO was received), or - indication that there is currently no active CTA (no CTA issued or no WILCO)
Title	Share CTA Instruction
Status	<Validated>
Rationale	The CTA Instruction is shared as part of the executive control data with adjacent ATSUs. This allows the adjacent centre to be aware that a flight is flying to a CTA before taking it under control. This information may be shared by OLDI (e.g. SDM) or through SWIM (e.g. an information service or flight object).
Category	<Functional>
Verification Method	<Test>
Validation Method	

[REQ Trace]

Relationship	Linked Element Type	Identifier	Compliance
<ALLOCATED_TO>	<Functional block>	Ground-Ground Legacy Datalink Communications (GGDC)	N/A
<ALLOCATED_TO>	<Functional block>	Ground-Ground IOP Mgt (GGIOP)	N/A
<ALLOCATED_TO>	<Functional block>	Trajectory Prediction & Mgt (TP&M)	N/A
<SATISFIES>	<Enabler>	ER APP ATC 100a/b/c	<Full>
<SATISFIES>	<ATMS Requirement>	REQ-05.06.01-OSED-SG06.0400	<Full>
<SATISFIES>	<ATMS Requirement>	REQ-05.06.01-Step 1SPR IT3-SAF1.0036	<Full>
<SATISFIES>	<ATMS Requirement>	REQ-05.06.01-Step 1SPR IT3-SAF1.0085	<Full>
<SATISFIES>	<ATMS Requirement>	REQ-05.06.01-Step 1SPR IT3-SAF1.0093	<Full>

founding members



Avenue de Cortenbergh 100 | B -1000 Bruxelles
www.sesarju.eu

47 of 97

3.1.2.5 Air-Ground CTA Consistency Check

EPP synchronisation allows the system to verify that the aircraft system and the ground system share the same view of any CTA constraint.

[REQ]

Identifier	REQ-10.02.01-TS-0001.0245
Requirement	A non-controlling system, in absence of any G/G link, shall assume that the CTA Instruction has WILCO-ed when the received EPP data show that the CTA applies on the metering fix.
Title	CTA status derived from EPP
Status	<In Progress>
Rationale	In absence of SWIM or modified OLDI, there is no means to notify downstream units that a CTA has been issued to the aircraft. Therefore where legacy G/G links are still in use this information is received directly from the aircraft in the EPP (EPP is requested approximately at coordination time and not before to avoid too many simultaneous connections).
Category	<Functional>
Verification Method	<Test>
Validation Method	

[REQ Trace]

Relationship	Linked Element Type	Identifier	Compliance
<ALLOCATED TO>	<Functional block>	Air-Ground Datalink Services (AGDS)	N/A
<ALLOCATED TO>	<Functional block>	Trajectory Prediction & Mgt (TP&M)	N/A
<SATISFIES>	<Enabler>	ER APP ATC 82	<Full>
<SATISFIES>	<ATMS Requirement>	REQ-05.05.01-OSED-0511.0013	<Full>
<SATISFIES>	<ATMS Requirement>	REQ-05.05.01-OSED-0511.005	<Full>

[REQ]

Identifier	REQ-10.02.01-TS-0002.0080
Requirement	The system shall display a warning on the controller HMI if the CTA is missing from the EPP and the CTA Instruction was WILCO-ed more that SP_TM0007 minutes ago.
Title	CTA not activated in EPP
Status	<Validated>
Rationale	Either the Flight Crew did not arm the CTA on the EPP, despite the acceptance of the CTA. Or there was a long response time of airborne system between CTA load in FMS and reception in ATC.
Category	<Functional><HMI>
Verification Method	<Test>
Validation Method	

[REQ Trace]

Relationship	Linked Element Type	Identifier	Compliance
<ALLOCATED_TO>	<Functional block>	Controller Human Machine Interaction Management	N/A
<ALLOCATED TO>	<Functional block>	Monitoring Aids (MONA)	N/A
<SATISFIES>	<Enabler>	ER APP ATC 82	<Full>
<SATISFIES>	<ATMS Requirement>	REQ-05.06.01-Step 1SPR IT3-SAF1.0083	<Full>

founding members



Avenue de Cortenbergh 100 | B -1000 Bruxelles
www.sesarju.eu

[REQ]

Identifier	REQ-10.02.01-TS-0004.0790
Requirement	The system shall display a warning on the controller HMI if an EPP is not received within SP_TM0007 minutes from the time the CTA Instruction was WILCO-ed.
Title	CTA not activated in FMS
Status	<In Progress>
Rationale	Either the Flight Crew did not arm the CTA on the EPP, despite the acceptance of the CTA, Or there was a long response time of airborne system between CTA load in FMS and reception in ATC.
Category	<Functional><HMI>
Verification Method	<Test>
Validation Method	

[REQ Trace]

Relationship	Linked Element Type	Identifier	Compliance
<ALLOCATED_TO>	<Functional block>	Controller Human Machine Interaction Management	N/A
<ALLOCATED_TO>	<Functional block>	Monitoring Aids (MONA)	N/A
<SATISFIES>	<Enabler>	ER APP ATC 82	<Full>
<SATISFIES>	<ATMS Requirement>	REQ-05.05.01-OSED-0511.SYS8.1	<Full>

founding members



Avenue de Cortenbergh 100 | B -1000 Bruxelles
www.sesarju.eu

3.1.2.6 RTA Achievable / Not Achievable

[REQ]

Identifier	REQ-10.02.01-TS-0004.0460
Requirement	The system shall display an alert on the controller HMI if the RTA status is “not achievable” as extracted from the last received EPP report.
Title	Display RTA status
Status	<In Progress>
Rationale	All controllers along the flight path of an i4D equipped a/c shall know if such aircraft flying under a 4D closed-loop constraint (i.e. an RTA resulting from a proposed CTA) is not any more able to comply with it.
Category	<Functional><HMI>
Verification Method	<Test>
Validation Method	

[REQ Trace]

Relationship	Linked Element Type	Identifier	Compliance
<ALLOCATED_TO>	<Functional block>	Controller Human Machine Interaction Management	N/A
<ALLOCATED_TO>	<Functional block>	Monitoring Aids (MONA)	N/A
<ALLOCATED_TO>	<Functional block>	Trajectory Prediction & Mgt (TP&M)	N/A
<SATISFIES>	<Enabler>	ER APP ATC 100a/b/c	<Full>
<SATISFIES>	<ATMS Requirement>	REQ-05.06.01-OSED-SG07.0200	<Full>
<SATISFIES>	<ATMS Requirement>	REQ-05.06.01-OSED-SG07.0300	<Full>

[REQ]

Identifier	REQ-10.02.01-TS-0005.0230
Requirement	The ground system shall provide an alert in case the active CTA is predicted to not be achievable based on ground trajectory predictions.
Title	CTA Real time monitoring
Status	<Validated>
Rationale	In the event the ground system predicts the likelihood that the CTA will be missed it will alert the controller. Note: it is not expected that the controller will take explicit action based solely on a ground alert.
Category	<Functional><HMI>
Verification Method	<Test>
Validation Method	

founding members



Avenue de Cortenbergh 100 | B -1000 Bruxelles
www.sesarju.eu

[REQ Trace]

Relationship	Linked Element Type	Identifier	Compliance
<ALLOCATED_TO>	<Functional block>	Controller Human Machine Interaction Management	N/A
<ALLOCATED_TO>	<Functional block>	Trajectory Prediction & Mgt (TP&M)	N/A
<SATISFIES>	<Enabler>	APP ATC 148	<Full>
<SATISFIES>	<ATMS Requirement>	REQ-05.06.01-OSED-SG07.0200	<Full>
<SATISFIES>	<ATMS Requirement>	REQ-05.06.01-OSED-SG07.0300	<Full>
<SATISFIES>	<ATMS Requirement>	REQ-05.06.01-Step 1SPR IT3-SAF1.0091	<Full>
<SATISFIES>	<ATMS Requirement>	REQ-05.06.01-Step 1SPR IT3-SAF1.0100	<Full>
<SATISFIES>	<ATMS Requirement>	REQ-05.06.01-Step 1SPR IT3-SAF1.0101	<Full>
<SATISFIES>	<ATMS Requirement>	REQ-05.06.01-Step 1SPR IT3-SAF1.0121	<Full>
<SATISFIES>	<ATMS Requirement>	REQ-05.06.01-Step 1SPR IT3-PRF1.0006	<Full>
<SATISFIES>	<ATMS Requirement>	REQ-05.06.01-Step 1SPR IT3-PRF1.0007	<Full>

3.1.3 2D Route Capability

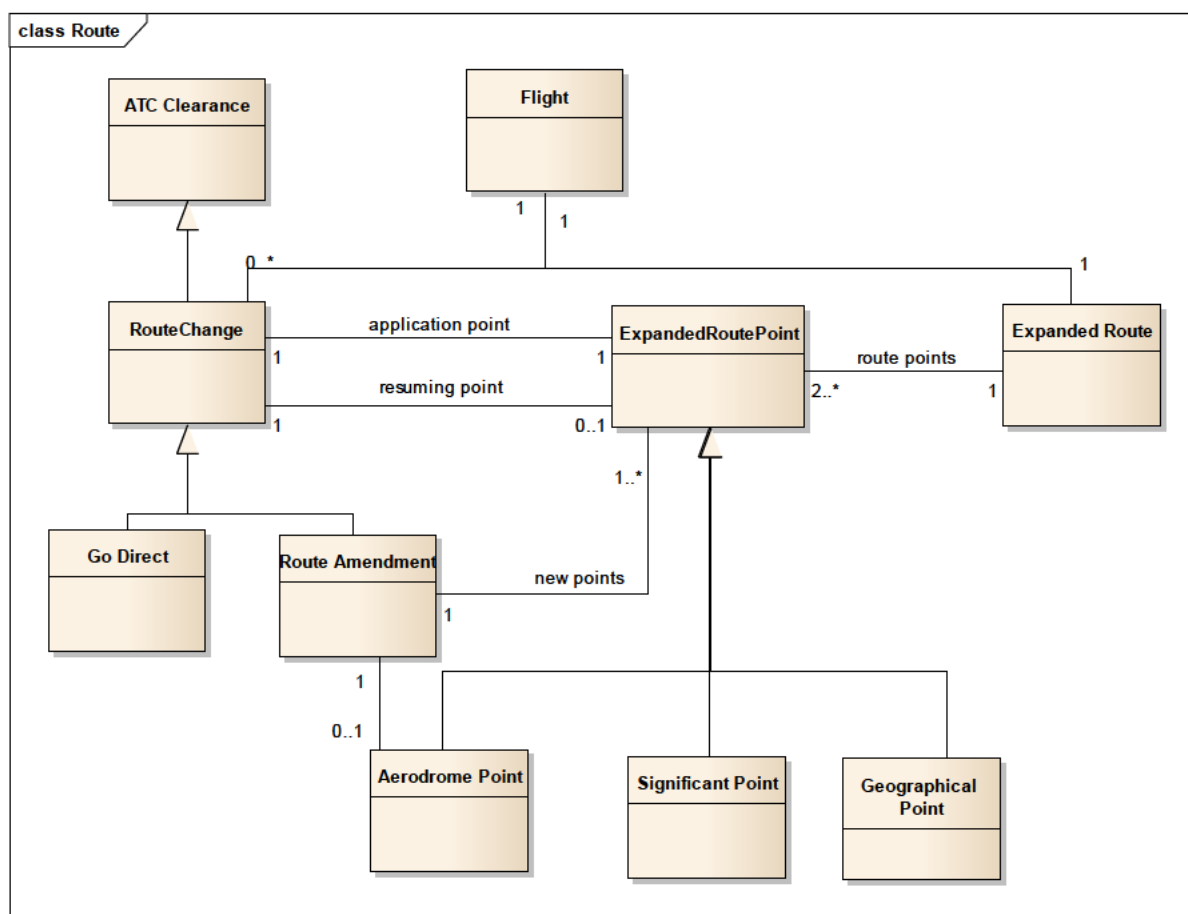

Figure 9: Route Domain

founding members



Avenue de Cortenbergh 100 | B -1000 Bruxelles
 www.sesarju.eu

Entity	Description
Aerodrome Point	A Route Point representing an Aerodrome; usually the departure or arrival point.
Application Point	Point at which a manoeuvre shall be started to execute an ATC instruction.
Expanded Route Point	A point that describes the horizontal path of a flight as planned by ATC. It will be revised by both planned and cleared Route Changes i.e. alternative routings that the aircraft is not yet cleared to follow (non-cleared route elements), and changes to the Cleared Route, e.g. when the aircraft is cleared from present position direct to a fix further along its route.
Geographical point	Point defined by geographical coordinates (lat., long.) or range and bearing from a significant point.
Go-Direct	An instruction to proceed directly to a given route point.
Route Amendment	An alteration to the route from the initial filed flight plan (SBT/SMT).
Route Point	A static 2D point, a sequence of which defines the 2D path of the aircraft. It can be an Aerodrome Point, Significant Point or a Geographical Point.
Route Change	A modification to the Planned Route representing a route clearance that has been issued or yet to be issued to the aircraft.
Significant point	A specified geographical location (identifiable by a name) used to define an Air Traffic Service (ATS) route, the flight path of an aircraft and/or for other navigation/ATS purposes (Eurocontrol lexicon).

3.1.3.1 Route Change

This section describes the manual change of 2D route by a controller or flight data operator. This manual change might be the result of a Pilot Request.

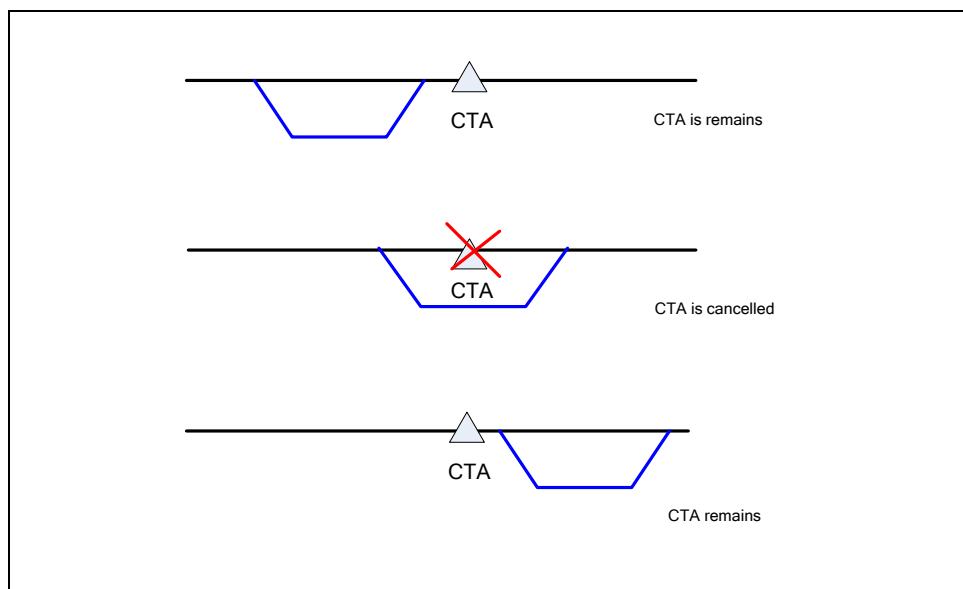

Figure 10 Route change impact on CTA

[REQ]

Identifier	REQ-10.02.01-TS-0001.0270
Requirement	On change of route, if the point on which a CTA applies is removed from the route, the system shall cancel the CTA.
Title	Cancellation of CTA on change of route
Status	<In Progress>
Rationale	The CTA is no longer valid if the metering fix is removed from the route. In this case the CTA cancellation is automatic for air and ground systems, so does not need to be uplinked. (Note that automatic cancellation and removal of the CTA occurs at all relevant ATSUs due to processing of the route amendment). If the distance-to-go is changed, an RTA missed might be downlinked.
Category	<Functional>
Verification Method	<Test>
Validation Method	

[REQ Trace]

Relationship	Linked Element Type	Identifier	Compliance
<ALLOCATED TO>	<Functional block>	Trajectory Prediction & Mgt (TP&M)	N/A
<SATISFIES>	<Enabler>	ER APP ATC 100a/b/c	<Full>
<SATISFIES>	<ATMS Requirement>	REQ-05.05.01-OSED-0511.BAP1.4	<Full>
<SATISFIES>	<ATMS Requirement>	REQ-05.05.01-OSED-0511.BAP1.2	<Full>
<SATISFIES>	<ATMS Requirement>	REQ-04.05-OSED-ATFCMFUA.018	<Full>

founding members



Avenue de Cortenbergh 100 | B -1000 Bruxelles
www.sesarju.eu

3.1.3.2 Full Route Clearance

[REQ]

Identifier	REQ-10.02.01-TS-0004.0600
Requirement	On receipt of a WILCO from the aircraft corresponding to a “full” route clearance, the system shall behave as if a WILCO had been received for each route change occurring within the scope of the route clearance.
Title	WILCO Full Route Clearance: Route Change
Status	<Validated>
Rationale	When the Controller HMI requests a full route clearance, the divergent portions may contain one or more route changes. If a WILCO is received for the portion, the system must be informed that each corresponding route change has also been WILCO-ed.
Category	<Functional>
Verification Method	<Test>
Validation Method	

[REQ Trace]

Relationship	Linked Element Type	Identifier	Compliance
<ALLOCATED_TO>	<Functional block>	Air-Ground Datalink Services (AGDS)	N/A
<ALLOCATED_TO>	<Functional block>	Trajectory Prediction & Mgt (TP&M)	N/A
<SATISFIES>	<Enabler>	ER APP ATC 104	<Full>
<SATISFIES>	<ATMS Requirement>	REQ-05.05.01-OSED-0511.001	<Full>

The figure below shows the different views of the 2D route. The system compares the EPP and expanded route, in order to detect divergences (shown in the figure below). The system uplinks route clearances to the aircraft in order to re-align the view.

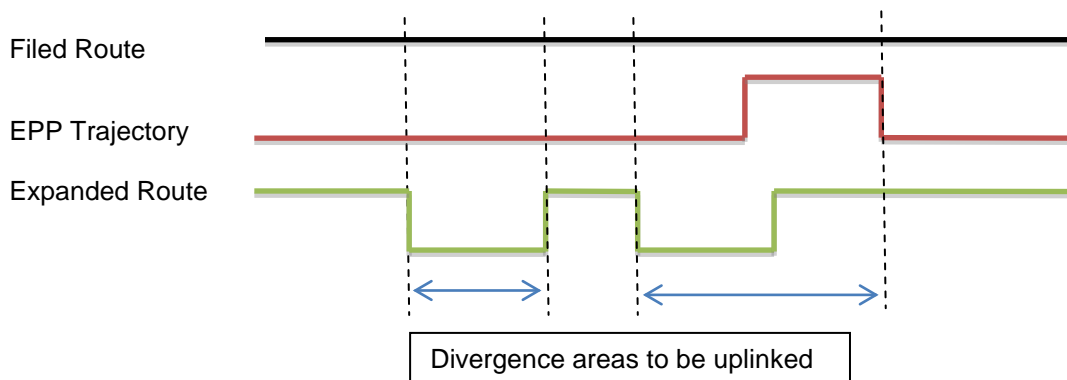

founding members



Avenue de Cortenbergh 100 | B -1000 Bruxelles
www.sesarju.eu

3.1.3.3 Display Route Changes

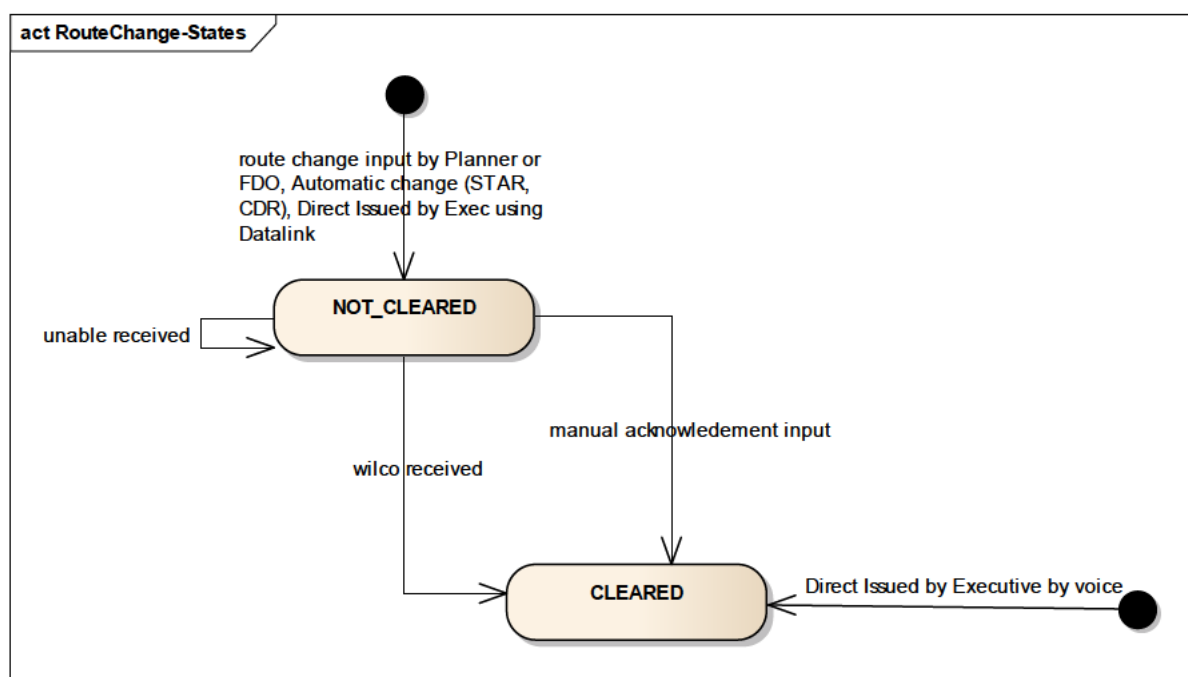

Figure 11 Route Change Operational Status Diagram

[REQ]

Identifier	REQ-10.02.01-TS-0003.0690
Requirement	The system shall provide an indication on the Controller HMI if the flight is approaching an un-cleared (see Figure 11) part of the route.
Title	Display Route Clearance status
Status	<Validated>
Rationale	The controller needs to be aware of the changes made to the cleared route by ATC such that a route clearance can be given if necessary, in order to keep the air and ground views aligned.
Category	<Functional><HMI>
Verification Method	<Test>
Validation Method	

[REQ Trace]

Relationship	Linked Element Type	Identifier	Compliance
<ALLOCATED_TO>	<Functional block>	Controller Human Machine Interaction Management	N/A
<ALLOCATED_TO>	<Functional block>	Trajectory Prediction & Mgt (TP&M)	N/A
<SATISFIES>	<Enabler>	ER APP ATC 104	<Full>
<SATISFIES>	<ATMS Requirement>	REQ-04.05-OSED-ATFCMFUA.022	<Full>

founding members



Avenue de Cortenbergh 100 | B -1000 Bruxelles
www.sesarju.eu

3.1.3.4 Air-Ground Route Clearance Conformance Check

[REQ]

Identifier	REQ-10.02.01-TS-0001.0030
Requirement	The system shall compare the list of points in a received EPP with the expanded route point list to check for 2D divergence.
Title	2D divergence check.
Status	<Validated>
Rationale	It is important that the controller and flight crew have a common view of the cleared route in order that the controller knows what the flight will do next and is able to plan rather than react tactically.
Category	<Functional>
Verification Method	<Test>
Validation Method	

[REQ Trace]

Relationship	Linked Element Type	Identifier	Compliance
<ALLOCATED_TO>	<Functional block>	Monitoring Aids (MONA)	N/A
<SATISFIES>	<Enabler>	ER APP ATC 82	<Full>
<SATISFIES>	<ATMS Requirement>	REQ-05.06.01-OSED-SG02.0200	<Full>
<SATISFIES>	<ATMS Requirement>	REQ-05.06.01-Step 1SPR IT3-SAF1.0011	<Full>
<SATISFIES>	<ATMS Requirement>	REQ-05.06.01-Step 1SPR IT3-SAF1.0014	<Full>
<SATISFIES>	<ATMS Requirement>	REQ-05.06.01-Step 1SPR IT3-SAF1.0121	<Full>
<SATISFIES>	<ATMS Requirement>	REQ-05.05.01-OSED-0511.SYS8.3.a.2	<Full>
<SATISFIES>	<ATMS Requirement>	REQ-04.05.00-OSED-F060-0050	<Full>

[REQ]

Identifier	REQ-10.02.01-TS-0001.0040
Requirement	The system shall make the route conformance check for the parts of the expanded route within the AOR that are: <ul style="list-style-type: none"> - not impacted by any route change, or - impacted by a WILCO route change
Title	Route Consistency check scope.
Status	<Validated>
Rationale	An inconsistency warning should not be raised for ground modified parts of the route which are already known to be divergent (i.e. impacted by a not yet WILCO-ed or UNABLE route change).
Category	<Functional>
Verification Method	<Test>
Validation Method	

[REQ Trace]

Relationship	Linked Element Type	Identifier	Compliance
<ALLOCATED_TO>	<Functional block>	Monitoring Aids (MONA)	N/A
<SATISFIES>	<Enabler>	ER APP ATC 82	<Full>
<SATISFIES>	<ATMS Requirement>	REQ-05.06.01-Step 1SPR IT3-SAF1.0112	<Full>
<SATISFIES>	<ATMS Requirement>	REQ-05.06.01-Step 1SPR IT3-SAF1.0121	<Full>
<SATISFIES>	<ATMS Requirement>	REQ-05.05.01-OSED-0511.SYS8.3.a.2	<Full>
<SATISFIES>	<ATMS Requirement>	REQ-04.05.00-OSED-F060-0050	<Full>

founding members



Avenue de Cortenbergh 100 | B -1000 Bruxelles
www.sesarju.eu

56 of 97

[REQ]

Identifier	REQ-10.02.01-TS-0001.0050
Requirement	The system shall display on the controller HMI a warning about the point of divergence (i.e. the last route point in common).when an air-ground 2D non-conformance is detected.
Title	Warning of air-ground 2D inconsistency.
Status	<Validated>
Rationale	The HMI displays a warning to the controller in order to take the appropriate action (i.e. revise the ground route or uplink a route clearance that will resolve any route inconsistencies) in order to align the air and ground routes.
Category	<Functional><HMI>
Verification Method	<Test>
Validation Method	

[REQ Trace]

Relationship	Linked Element Type	Identifier	Compliance
<ALLOCATED_TO>	<Functional block>	Controller Human Machine Interaction Management	N/A
<ALLOCATED_TO>	<Functional block>	Monitoring Aids (MONA)	N/A
<SATISFIES>	<Enabler>	ER APP ATC 82	<Full>
<SATISFIES>	<ATMS Requirement>	REQ-05.06.01-OSED-SG02.0300	<Full>
<SATISFIES>	<ATMS Requirement>	REQ-05.06.01-Step 1SPR IT3-SAF1.0011	<Full>
<SATISFIES>	<ATMS Requirement>	REQ-05.06.01-Step 1SPR IT3-SAF1.0014	<Full>
<SATISFIES>	<ATMS Requirement>	REQ-05.06.01-Step 1SPR IT3-SAF1.0015	<Full>
<SATISFIES>	<ATMS Requirement>	REQ-05.06.01-Step 1SPR IT3-SAF1.0112	<Full>
<SATISFIES>	<ATMS Requirement>	REQ-05.05.01-OSED-0511.SYS8.3.a.2	<Full>
<SATISFIES>	<ATMS Requirement>	REQ-04.05.00-OSED-F060-0070	<Full>
<SATISFIES>	<ATMS Requirement>	REQ-04.05.00-OSED-F060-0080	<Full>
<SATISFIES>	<ATMS Requirement>	REQ-04.05.00-OSED-F060-0090	<Full>

founding members



Avenue de Cortenbergh 100 | B -1000 Bruxelles
www.sesarju.eu

57 of 97

3.1.4 Standard Arrival Procedures Capability

Arrivals and departures are managed using Standard Instrument Departure routes (SID) and Standard Terminal Arrival Routes (STAR). SIDs and STARs are intended to ensure the safe and efficient flow of air traffic operating to and from the same or different runways, at the same or neighbouring airfields.

SIDs and STARs aim to de-conflict potentially conflicting traffic by the use of specific routings and levels. Typically, each runway will have a number of SIDs and STARs to ensure that air traffic is not unnecessarily delayed by deviation from or to the aerodrome.

The STAR defines the intended arrival route from the STAR point to the Initial Approach Fix (IAF), after which the Instrument Approach Procedure (IAP) is applied in order to arrive at the FAF.

Furthermore, having the knowledge about runways in use and the allocated STAR enables the ENR ATC System to pass the information to arriving aircraft.

Runway configuration can be modified on short notice because of weather (wind direction), tactical conditions or local procedures (e.g. noise abatement procedures). These changes may occur frequently. Currently this information is passed verbally and the environment databases of the ATC systems are updated manually.

The aim is to provide an automated support for passing the STAR allocation and the runway usage information in order to allow automatic STAR allocation and early uplink.

Entity	Description
Standard Terminal Arrival Route (STAR)	A designated instrument flight rule (IFR) arrival route linking a significant point, normally on an ATS route, with a point from which a published Instrument Approach Procedure can be commenced [ICAO].
IAF	Initial Approach Fix. The Initial Approach Fix is the point where an instrument approach procedure begins.
Aerodrome Group	Set of aerodromes inter-dependant for the use of runways. The set can be a single aerodrome.
Runway Configuration	Configuration for take-off or landing of the runways in an aerodrome group.
STAR Allocation	The STAR expected to be flown based on conditions such as the runway configuration at the time of arrival.
STAR Clearance	ATC clearance giving authorisation for a certain STAR to be flown

The choice of STAR, determines the IAF, which is the point on which the AMAN will typically put the CTA. Therefore the STAR should be allocated in advance of CTA setting.

The choice of STAR also affects the Top of Descent (TOD) for the aircraft because the allocation of a STAR changes the track miles to go to landing (as shown in the diagrams below). Earlier allocation and synchronisation of the STAR, which facilitates more accurate and earlier TOD calculation, will permit fewer steps during descent. Therefore, this becomes an enabler for Continuous Descent Approaches (CDA), another capability being developed for SESAR.

Two cases are considered:

Case 1: STAR allocated by the C-ATSU:

founding members



Avenue de Cortenbergh 100 | B -1000 Bruxelles
www.sesarju.eu

- ENR (C-ATSU) allocates STAR based on runway configuration
- C-ATSU uplinks STAR clearance to a/c
- C-ATSU provides the allocated STAR to D-ATSU for information

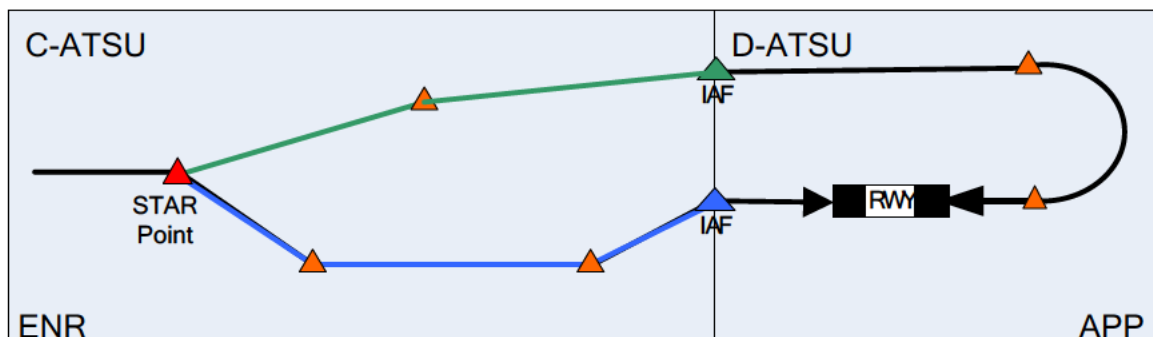

Figure 12 STAR in C-ATSU

Case 2: STAR allocated by the D-ATSU:

- D-ATSU allocates STAR based on runway configuration
- D-ATSU provides the STAR to C-ATSU
- ENR/C-ATSU uplinks STAR allocation to a/c

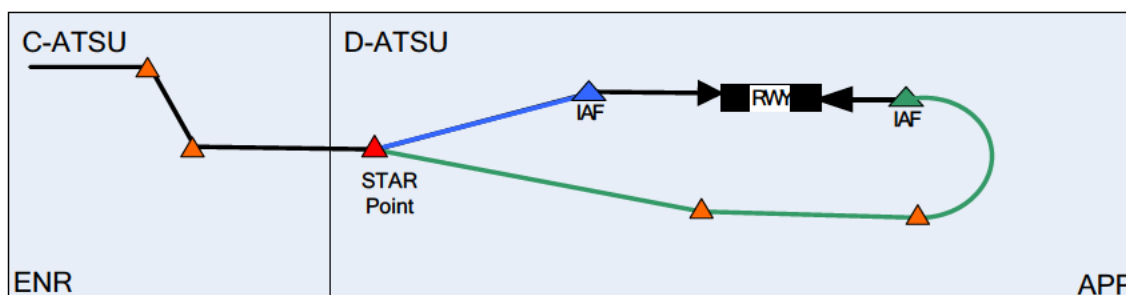

Figure 13 STAR in D-ATSU

Note that there are currently no requirements covering the 3rd bullet of case 2 (clearance of STAR in a downstream unit) as this case is not covered by the available release of the 4.5 TMF Technical Note, because the coordination with P5.6.1 is still on-going. In absence of the appropriate user case is not possible to define the appropriate requirement.

3.1.4.1 Share STAR allocation

[REQ]

Identifier	REQ-10.02.01-TS-0005.0080
Requirement	The system shall override the locally allocated STAR with the latest STAR allocation received from the ATSU containing the STAR point.
Title	Receive STAR allocation
Status	<Validated>
Rationale	The ATSU responsible for the STAR allocation is able to provide the accurate information to adjacent upstream and downstream ATSUs.
Category	<Functional>
Verification Method	<Test>
Validation Method	

[REQ Trace]

Relationship	Linked Element Type	Identifier	Compliance
<ALLOCATED_TO>	<Functional block>	Ground-Ground Legacy Datalink Communications (GGDC)	N/A
<ALLOCATED_TO>	<Functional block>	Ground-Ground IOP Mgt (GGIOP)	N/A
<ALLOCATED_TO>	<Functional block>	Trajectory Prediction & Mgt (TP&M)	N/A
<SATISFIES>	<Enabler>	ER APP ATC 101	<Full>
<SATISFIES>	<ATMS Requirement>	REQ-04.05.00-OSED-F010-0070	<Full>

founding members



Avenue de Cortenbergh 100 | B -1000 Bruxelles
www.sesarju.eu

60 of 97

3.1.5 Predict 4D Ground Trajectory Capability

3.1.5.1 Predict Trajectory

The system will create a planned trajectory which forms the local view of the RBT/RMT. Initially this will be created using IFPS flight plan data and subsequently updated by controller inputs, surveillance data, aircraft derived data and controller tools.

[REQ]

Identifier	REQ-10.02.01-TS-0002.0010
Requirement	The system shall compute a planned trajectory for each flight plan.
Title	Local view of RBT/RMT
Status	<Validated>
Rationale	Need to create a local view of the RBT/RMT for all flight plans. This is valid for both i4D and non-i4d aircraft. For i4D aircraft once the EPP is received it may be used to update the local trajectory. The trajectory is displayed on the HMI and used by controller tools and AMAN.
Category	<Functional>
Verification Method	<Test>
Validation Method	

[REQ Trace]

Relationship	Linked Element Type	Identifier	Compliance
<ALLOCATED_TO>	<Functional block>	Trajectory Prediction & Mgt (TP&M)	N/A
<ALLOCATED_TO>	<Functional block>	Controller Human Machine Interaction Management	N/A
<SATISFIES>	<Enabler>	ER APP ATC 149	<Full>
<SATISFIES>	<ATMS Requirement>	REQ-05.06.01-OSED-SG02.0200	<Full>
<SATISFIES>	<ATMS Requirement>	REQ-05.06.01-Step 1SPR IT3-SAF1.0069	<Full>
<SATISFIES>	<ATMS Requirement>	REQ-05.06.01-Step 1SPR IT3-SAF1.0092	<Full>

founding members



Avenue de Cortenbergh 100 | B -1000 Bruxelles
www.sesarju.eu

61 of 97

3.1.5.2 Apply CTA

Once issued to the aircraft as an instruction the CTA is reflected in the planned trajectory.

[REQ]

Identifier	REQ-10.02.01-TS-0001.0210
Requirement	When a CTA on a point is different from the current calculated time at the point (+/-tolerance), the system shall compute the planned trajectory applying a change of airspeed within the normal operating envelope and without any additional level change in order to attempt to comply with the constraint.
Title	Inclusion of CTA in ground trajectory.
Status	<Validated>
Rationale	Many tools and system functions work based on the ground TP, so the trajectory must be recomputed taking into account the CTA which can bring a 4D change to the trajectory.
Category	<Functional>
Verification Method	<Test>
Validation Method	

[REQ Trace]

Relationship	Linked Element Type	Identifier	Compliance
<ALLOCATED_TO>	<Functional block>	Trajectory Prediction & Mgt (TP&M)	N/A
<SATISFIES>	<Enabler>	ER APP ATC 149	<Full>
<SATISFIES>	<ATMS Requirement>	REQ-05.05.01-OSED-0511.008.3	<Full>

[REQ]

Identifier	REQ-10.02.01-TS-0001.0320
Requirement	If the aircraft state is not known for a flight, the system shall choose an ETO over the first trajectory point in order that a CTA is reached without changing the user preferred airspeed.
Title	Use of CTA as temporal reference.
Status	<In Progress>
Rationale	The CTA may be input in ENR before the aircraft is correlated in the APP. This implies a time shift of trajectory.
Category	<Functional>
Verification Method	<Test>
Validation Method	

[REQ Trace]

Relationship	Linked Element Type	Identifier	Compliance
<ALLOCATED_TO>	<Functional block>	Trajectory Prediction & Mgt (TP&M)	N/A
<SATISFIES>	<Enabler>	ER APP ATC 149	<Full>
<SATISFIES>	<ATMS Requirement>	REQ-05.05.01-OSED-0511.010	<Full>

founding members



Avenue de Cortenbergh 100 | B -1000 Bruxelles
www.sesarju.eu

62 of 97

3.1.5.3 Improve TP with Mode-S ADD

This capability allows the ground ATC to use the Indicated Airspeed (IAS)/ Mach received by Mode-S surveillance in order to improve the ground-TP.

Indicated Airspeed (IAS)/Mach is considered to be a key ADD parameter for use in TP, because aircraft maintain constant IAS or Mach during climbs and descents phases; therefore the current observed IAS/Mach can often be used as a good predictor of the future airspeed. The BADA aircraft performance model reflects this by defining a speed profile for each aircraft type consisting of three defined speed parameters for each phase of flight (climb, and descent):

- V1 - standard CAS (knots) below 10,000 ft;
- V2 - standard CAS (knots) between 10,000 ft and Mach transition altitude;
- M - standard Mach number above Mach transition altitude;

Below approximately 10,000ft the aircraft flies a constant indicated airspeed (IAS) of 250 knots. This is set by ATC procedures (V1). Above approximately 10,000ft the aircraft attains and then maintains a constant IAS (V2) until it reaches the Mach transition altitude. As the aircraft climbs through its Mach transition altitude the aircraft switches to a constant Mach (M) regime.

The values defined in the BADA model represent generic values for an aircraft type, which are average values covering different airline operators and routes.

The mode S down-linked IAS/Mach may enable more accurate TP predictions because it provides an actual value for the individual aircraft, which may be used in place of the generic BADA model value to predict the aircraft behaviour during the constant IAS/Mach phase.

[REQ]

Identifier	REQ-10.02.01-TS-0005.0090
Requirement	If available, the system shall use the Mode S IAS or Mach for the initial speed on the first point of the predicted trajectory.
Title	Mode S IAS for Initial Condition
Status	<Validated>
Rationale	Use of actual aircraft speed in TP increases accuracy.
Category	<Functional>
Verification Method	<Test>
Validation Method	

[REQ Trace]

Relationship	Linked Element Type	Identifier	Compliance
<ALLOCATED TO>	<Functional block>	Surveillance (SUR)	N/A
<ALLOCATED TO>	<Functional block>	Trajectory Prediction & Mgt (TP&M)	N/A
<SATISFIES>	<Enabler>	ER APP ATC 104	<Full>
<SATISFIES>	<ATMS Requirement>	REQ-04.05.00-OSED-S100-0010	<Full>
<SATISFIES>	<ATMS Requirement>	REQ-04.05.00-OSED-S100-0020	<Full>

[REQ]

Identifier	REQ-10.02.01-TS-0005.0100
Requirement	The system shall derive the BADA “V2” parameter (constant climb/descent IAS) from the Mode S IAS, if <ul style="list-style-type: none"> - the aircraft is climbing (resp. descending) - the aircraft is above 10,000 FT, and - no speed instruction is active, and - Mode S IAS value is stable (not increasing/decreasing)
Title	V2 speed parameter from Mode S IAS
Status	<Validated>
Rationale	The mode S down-linked IAS value may enable more accurate TP predictions because it provides an actual value for the individual aircraft, which may be used in place of the generic BADA model value to predict the aircraft behaviour during the constant IAS phase.
Category	<Functional>
Verification Method	<Test>
Validation Method	

[REQ Trace]

Relationship	Linked Element Type	Identifier	Compliance
<ALLOCATED TO>	<Functional block>	Trajectory Prediction & Mgt (TP&M)	N/A
<SATISFIES>	<Enabler>	ER APP ATC 104	<Full>
<SATISFIES>	<ATMS Requirement>	REQ-04.05.00-OSED-F090-0020	<Full>

[REQ]

Identifier	REQ-10.02.01-TS-0005.0110
Requirement	The system shall derive the BADA “M” parameter (constant climb/descent Mach) from the Mode S Mach, if <ul style="list-style-type: none"> - the aircraft is climbing (resp. descending) - the aircraft is above 10,000 FT, and - no speed instruction is active, and - Mode S Mach value is stable (not increasing/decreasing)
Title	M speed parameter
Status	<Validated>
Rationale	The mode S down-linked Mach value may enable more accurate TP predictions because it provides an actual value for the individual aircraft, which may be used in place of the generic BADA model value to predict the aircraft behaviour during the constant Mach phase. The ground system has to detect when the IAS/Mach crossover has occurred.
Category	<Functional>
Verification Method	<Test>
Validation Method	

[REQ Trace]

Relationship	Linked Element Type	Identifier	Compliance
<ALLOCATED TO>	<Functional block>	Trajectory Prediction & Mgt (TP&M)	N/A
<SATISFIES>	<Enabler>	ER APP ATC 104	<Full>
<SATISFIES>	<ATMS Requirement>	REQ-04.05.00-OSED-F090-0020	<Full>

founding members



Avenue de Cortenbergh 100 | B -1000 Bruxelles
www.sesarju.eu

64 of 97

3.1.5.4 Improve TP with FOC/WOC Flight Performance Data

An **Extended Flight Plan (EFPL)** is a flight plan message which, in addition to the ICAO defined flight plan information, includes flight trajectory information in the form of a 4D trajectory, as calculated by the operator of the flight, as well as Performance Data specific to the flight.

An EFPL supplements the ICAO 4444 flight plan with the following additional information:

- **4D Trajectory:** AU calculated flight trajectory taking into account constraints and meteorological information for its calculation.
- **Flight Performance Data:** it represents the climbing and descending capabilities of the aircraft specific to the flight, taking into account the performance of the airframe that is used to operate the flight as well as any other parameters that may influence it such as engine settings and status, cost factor applied by the operator. The Flight Performance Data may be provided either as climb and descent performance profile or as the total weight of aircraft as part of the 4D trajectory (see the 4D trajectory content description above).

The flight performance Data consists of climb and descent performance profiles described as a sequence of points in which every point is defined by:

- Cumulative Distance from the aerodrome of departure
- Level: Altitude above mean sea level (MSL) in feet (ft) or meters (m) or Flight level (FL).
- Cumulative Time elapsed from the aerodrome of departure

The ATC system must derive the aircraft performance parameters to feed into the BADA model from the performance profile in order to improve the accuracy of the local TP.

The typical procedure is to first compute the ground speed (distance/time) for each point in the performance profile. Then as the flight performance data doesn't consider any meteorological data, ground speed is equivalent to TAS. Finally the IAS and Mach number can be computed from the TAS based on the International Standard Atmosphere (ISA) conditions at the given level.

From the IAS and Mach values the constant IAS climb speed (BADA “V2” parameter) and also the transition to a constant Mach number (BADA “M” parameter) can be deduced.

[REQ]

Identifier	REQ-10.02.01-TS-0005.0120
Requirement	The system shall derive the BADA “V2” parameters (constant climb/descent IAS) from the aircraft operator’s climb/descent performance profiles.
Title	Use of FOC/WOC profile to determine IAS component of speed schedule
Status	<Validated>
Rationale	EFPL data provides FOC/WOC information like take-off mass and climb/descent speeds which are currently estimated by ATC in trajectory prediction processes. Extended Flight Plan information, referenced in [4] SESAR 04.05 D822 as taken from P07.06.02, include: - Total Weight, including The total weight at the ADEP is the Take-Off Weight (TOW). - True air speed: Estimated speed of the aircraft at the location expressed as Mach number or True Air Speed (TAS). Note: this can bring to an approximate evaluation of BADA “V2” parameter, IAS may be derived by TAS, using Level and estimated Temperature (ISO or GRIB derived). - Mach number: Estimated speed of the aircraft at the location expressed as Mach number
Category	<Functional>
Verification Method	<Test>
Validation Method	

[REQ Trace]

Relationship	Linked Element Type	Identifier	Compliance
<ALLOCATED_TO>	<Functional block>	Ground-Ground Legacy Datalink Communications (GGDC)	N/A
<ALLOCATED_TO>	<Functional block>	Trajectory Prediction & Mgt (TP&M)	N/A
<SATISFIES>	<Enabler>	ER APP ATC 104	<Full>
<SATISFIES>	<ATMS Requirement>	REQ-04.05.00-OSED-S110-0010	<Full>

[REQ]

Identifier	REQ-10.02.01-TS-0005.0130
Requirement	The system shall derive the BADA “M” parameters (constant climb/descent Mach) from the aircraft operator’s climb/descent performance profile.
Title	Use of FOC/WOC profile to determine Mach component of speed schedule
Status	<Validated>
Rationale	The parameters from the aircraft are more accurate than the BADA ones. EFPL data provides FOC/WOC information like take-off mass and climb/descent speeds which are currently estimated by ATC in trajectory prediction processes.
Category	<Functional>
Verification Method	<Test>
Validation Method	

[REQ Trace]

Relationship	Linked Element Type	Identifier	Compliance
<ALLOCATED_TO>	<Functional block>	Ground-Ground Legacy Datalink Communications (GGDC)	N/A

founding members



Avenue de Cortenbergh 100 | B -1000 Bruxelles
www.sesarju.eu

66 of 97

<ALLOCATED_TO>	<Functional block>	Trajectory Prediction & Mgt (TP&M)	N/A
<SATISFIES>	<Enabler>	ER APP ATC 104	<Full>
<SATISFIES>	<ATMS Requirement>	REQ-04.05.00-OSED-S110-0030	<Full>
<SATISFIES>	<ATMS Requirement>	REQ-04.05.00-OSED-S110-0010	<Full>

[REQ]

Identifier	REQ-10.02.01-TS-0005.0140
Requirement	The system shall use the mass from the corresponding point in the aircraft operator's 4D profile as mass on the first point of the planned trajectory.
Title	Extraction of mass from FOC/WOC profile
Status	<Validated>
Rationale	Opportunity to improve TP accuracy with reliable mass from FOC/WOC. The 4D trajectory in the EFPL and the locally predicted trajectory may have different scopes. If the first point of the planned trajectory is the ADEP this corresponds to the Take –off weight (TOW).
Category	<Functional>
Verification Method	<Test>
Validation Method	

[REQ Trace]

Relationship	Linked Element Type	Identifier	Compliance
<ALLOCATED_TO>	<Functional block>	Ground-Ground Legacy Datalink Communications (GGDC)	N/A
<ALLOCATED_TO>	<Functional block>	Trajectory Prediction & Mgt (TP&M)	N/A
<SATISFIES>	<Enabler>	ER APP ATC 100a/b/c	<Full>
<SATISFIES>	<ATMS Requirement>	REQ-04.05.00-OSED-S110-0010	<Full>
<SATISFIES>	<ATMS Requirement>	REQ-04.05.00-OSED-S110-0030	<Full>

[REQ]

Identifier	REQ-10.02.01-TS-0003.0680
Requirement	The system shall check received FOC/WOC data against existing flight plan data: FOC/WOC data can be associated to an existing flight plan in local system database: - Take-Off weight is consistent with current aircraft type - Climb/descent/cruise speeds are within min max aircraft capacities along the climb/cruise/descent phase
Title	FOC/WOC data checks
Status	<Validated>
Rationale	Ensure integrity of TP function EFPL data provides FOC/WOC information like take-off mass and climb/descent speeds which are currently estimated by ATC in trajectory prediction processes.
Category	<Functional>
Verification Method	<Test>
Validation Method	

[REQ Trace]

Relationship	Linked Element Type	Identifier	Compliance
<ALLOCATED_TO>	<Functional block>	Ground-Ground Legacy Datalink Communications (GGDC)	N/A
<ALLOCATED_TO>	<Functional block>	Trajectory Prediction & Mgt (TP&M)	N/A
<SATISFIES>	<Enabler>	ER APP ATC 82	<Full>
<SATISFIES>	<ATMS Requirement>	REQ-04.05.00-OSED-S110-0010	<Full>
<SATISFIES>	<ATMS Requirement>	REQ-04.05.00-OSED-S110-0030	<Full>

founding members



Avenue de Cortenbergh 100 | B -1000 Bruxelles
www.sesarju.eu

67 of 97

[REQ]

Identifier	REQ-10.02.01-TS-0005.0150
Requirement	In the following order of priority (high to low), the system shall use as BADA "V2" and "M" parameters for the trajectory prediction: - the values derived from the aircraft operator's performance profile (EFPL) - the values derived from Mode S IAS - the offline defined default value
Title	Speed Schedule Priority
Status	<Validated>
Rationale	The parameters from the aircraft operator are more accurate than the BADA ones.
Category	<Functional>
Verification Method	<Test>
Validation Method	

[REQ Trace]

Relationship	Linked Element Type	Identifier	Compliance
<ALLOCATED TO>	<Functional block>	Trajectory Prediction & Mgt (TP&M)	N/A
<SATISFIES>	<Enabler>	ER APP ATC 104	<Full>
<SATISFIES>	<ATMS Requirement>	REQ-04.05.00-OSED-S110-0010	<Full>
<SATISFIES>	<ATMS Requirement>	REQ-04.05.00-OSED-S110-0030	<Full>

founding members



Avenue de Cortenbergh 100 | B -1000 Bruxelles
www.sesarju.eu

3.1.5.5 Improve TP with ADS-C ADD

This capability allows the ground ATC to make air and ground trajectories “consistent” such that they can be displayed on the Controller HMI and can be used to feed ATC tools

[REQ]

Identifier	REQ-10.02.01-TS-0001.0350
Requirement	The system may use relevant EPP data to update ground TP predicted trajectory by using airborne computed data.
Title	Use down-linked EPP data to improve accuracy of ground trajectory
Status	<Validated>
Rationale	The ADS-C received data may be used by the ground ATM system to update ground predicted trajectory. Relevant EPP data that may be used are mass, speed schedule, ETO, TOD. The usage of relevant EPP data shall allow an improvement in the accuracy of the ground TP performed by an ATSU
Category	<Functional>
Verification Method	<Test>
Validation Method	

[REQ Trace]

Relationship	Linked Element Type	Identifier	Compliance
<ALLOCATED_TO>	<Functional block>	Air-Ground Datalink Services (AGDS)	N/A
<ALLOCATED_TO>	<Functional block>	Trajectory Prediction & Mgt (TP&M)	N/A
<SATISFIES>	<Enabler>	ER APP ATC 104	<Full>
<SATISFIES>	<ATMS Requirement>	REQ-05.05.01-OSED-0511.001	<Full>
<SATISFIES>	<ATMS Requirement>	REQ-05.06.01-OSED-SG02.0200	<Full>
<SATISFIES>	<ATMS Requirement>	REQ-05.06.01-OSED-SG7a.0100	<Full>
<SATISFIES>	<ATMS Requirement>	REQ-04.05.00-OSED-F060-0120	<Full>
<SATISFIES>	<ATMS Requirement>	REQ-04.05.00-OSED-F060-0130	<Full>
<SATISFIES>	<ATMS Requirement>	REQ-04.05.00-OSED-F060-0140	<Full>

[REQ]

Identifier	REQ-10.02.01-TS-0002.0090
Requirement	The system shall update the ground trajectory using the EPP only if the EPP is less than SP_TM0013 minutes old.
Title	Out of date EPP
Status	<Validated>
Rationale	Out of date EPP should not be used to update the ground TP because it is no longer accurate.
Category	<Functional>
Verification Method	<Test>
Validation Method	

[REQ Trace]

Relationship	Linked Element Type	Identifier	Compliance
<ALLOCATED_TO>	<Functional block>	Trajectory Prediction & Mgt (TP&M)	N/A
<SATISFIES>	<Enabler>	ER APP ATC 104	<Full>
<SATISFIES>	<ATMS Requirement>	REQ-05.05.01-OSED-0511.003	<Full>
<SATISFIES>	<ATMS Requirement>	REQ-05.05.01-OSED-0511.002	<Full>
<SATISFIES>	<ATMS Requirement>	REQ-05.06.01-OSED-SG02.0200	<Full>

founding members



Avenue de Cortenbergh 100 | B -1000 Bruxelles
www.sesarju.eu

69 of 97

3.1.5.6 TP uncertainty

To reach Trajectory Based Operation it is necessary that ATC system determines the quality and the accuracy of the planned trajectory. It is in particular very important for Separation Management services. In step 1, the time uncertainty is key in the concept. It needs to take into account the fact that the i4D connection and possibly on-going CTA will improve the predicted times accuracy. The uncertainty is expressed along the waypoints but it is left to the implementation to implement online uncertainty values or calibrated fixed uncertainties that can be obtained by offline statistical studies or by published standards (like from WG85 publications).

[REQ]

Identifier	REQ-10.02.01-TS-0002.0500
Requirement	The system shall compute the predicted time uncertainty (min/max time) for each waypoint of the trajectory, taking into account the availability and accuracy of data that impacts directly the time uncertainty.
Title	Trajectory Predicted times uncertainty
Status	<In Progress>
Rationale	Needed for conflicts and resolution detection tools.
Category	<Functional>
Verification Method	<Test>
Validation Method	

[REQ Trace]

Relationship	Linked Element Type	Identifier	Compliance
<SATISFIES>	<Enabler>	ER APP ATC 82	<Full>
<ALLOCATED TO>	<Functional block>	Trajectory Prediction & Mgt (TP&M)	N/A

[REQ]

Identifier	REQ-10.02.01-TS-0003.0710
Requirement	The system shall compute the predicted level uncertainty (min/max level) for each waypoint of the trajectory, taking into account the availability and accuracy of data that impacts directly the level uncertainty.
Title	Trajectory Predicted Level uncertainty
Status	<In Progress>
Rationale	Needed for conflicts and resolution detection tools. Note that requirement is optional for step 1 because only time uncertainty is needed for time based operations; however the requirement is included because when computing time uncertainty using a 4D prediction, also the level uncertainty can be indirectly obtained.
Category	<Functional>
Verification Method	<Test>
Validation Method	

[REQ Trace]

Relationship	Linked Element Type	Identifier	Compliance
<SATISFIES>	<Enabler>	ER APP ATC 82	<Full>
<ALLOCATED TO>	<Functional block>	Trajectory Prediction & Mgt (TP&M)	N/A

founding members



Avenue de Cortenbergh 100 | B -1000 Bruxelles
www.sesarju.eu

70 of 97

3.1.5.7 TP in PBN operations

It is necessary that ATC system predict the trajectory with enough accuracy to allow the PBN operation and reduction of route lateral separation to be supported. ATC systems need also to support the new PBN operational procedures.

[REQ]

Identifier	REQ-10.02.01-TS-0005.0300
Requirement	The system shall predict the En-route part of the trajectory with an off track error on straight and turning paths compatible with En-route PBN operations (7NM route separation).
Title	En-route accuracy
Status	<Validated>
Rationale	To safely allow the reduction of the route separation to 7NM in En-route.
Category	<Functional>
Verification Method	<Test>
Validation Method	

[REQ Trace]

Relationship	Linked Element Type	Identifier	Compliance
<ALLOCATED_TO>	<Functional block>	Trajectory Prediction & Mgt (TP&M)	N/A
<SATISFIES>	<Enabler>	ER APP ATC 100a/b/c	<Full>
<SATISFIES>	<ATMS Requirement>	REQ-04.07.03-OSED-0001.0001	<Full>
<SATISFIES>	<ATMS Requirement>	REQ-04.07.03-OSED-0001.0003	<Full>
<SATISFIES>	<ATMS Requirement>	REQ-04.07.03-OSED-0001.0004	<Full>
<SATISFIES>	<ATMS Requirement>	REQ-04.07.03-SPR-0001.0005	<Full>

[REQ]

Identifier	REQ-10.02.01-TS-0005.0310
Requirement	The system shall predict the trajectory at the TMA interface with an off track error compatible with PBN operations at TMA entry (6NM route separation).
Title	TMA accuracy
Status	<Validated>
Rationale	To safely allow the reduction of the route separation to 6NM in TMA.
Category	<Functional>
Verification Method	<Test>
Validation Method	

[REQ Trace]

Relationship	Linked Element Type	Identifier	Compliance
<ALLOCATED_TO>	<Functional block>	Trajectory Prediction & Mgt (TP&M)	N/A
<SATISFIES>	<Enabler>	APP ATC 94	<Full>
<SATISFIES>	<ATMS Requirement>	REQ-04.07.03-OSED-0001.0002	<Full>
<SATISFIES>	<ATMS Requirement>	REQ-04.07.03-OSED-0001.0003	<Full>
<SATISFIES>	<ATMS Requirement>	REQ-04.07.03-OSED-0001.0004	<Full>
<SATISFIES>	<ATMS Requirement>	REQ-04.07.03-SPR-0001.0005	<Full>

[REQ]

Identifier	REQ-10.02.01-TS-0005.0320
Requirement	The system shall be able to predict a trajectory that follows a given parallel offsets ATCO instructions (used by ATCO as alternative to radar vectoring) to the planned route.

founding members



Avenue de Cortenbergh 100 | B -1000 Bruxelles
www.sesarju.eu

Title	Parallel offset
Status	<In Progress>
Rationale	The Air Traffic Controller can use Tactical Parallel Offsets in place of radar vectoring.
Category	<Functional>
Verification Method	<Test>
Validation Method	

[REQ Trace]

Relationship	Linked Element Type	Identifier	Compliance
<ALLOCATED TO>	<Functional block>	Trajectory Prediction & Mgt (TP&M)	N/A
<SATISFIES>	<Enabler>	ER APP ATC 100a/b/c	<Full>
<SATISFIES>	<ATMS Requirement>	REQ-04.07.03-OSED-0001.0002	<Full>
<SATISFIES>	<ATMS Requirement>	REQ-04.07.03-OSED-0001.0006	<Full>

[REQ]

Identifier	REQ-10.02.01-TS-0005.0330
Requirement	The system shall be able to predict the trajectory in a free route environment.
Title	Accuracy for MTCD
Status	<Validated>
Rationale	The trajectory needs to be correctly predicted even when free route is used.
Category	<Functional>
Verification Method	<Test>
Validation Method	

[REQ Trace]

Relationship	Linked Element Type	Identifier	Compliance
<ALLOCATED TO>	<Functional block>	Air-Ground Datalink Services (AGDS)	N/A
<ALLOCATED TO>	<Functional block>	Arrival Mgt (AMAN)	N/A
<SATISFIES>	<Enabler>	ER APP ATC 100a/b/c	<Full>
<SATISFIES>	<ATMS Requirement>	REQ-04.07.03-SPR-0001.0006	<Full>

3.1.5.8 Trajectory Calculation

It is necessary define the requirement for the Trajectory Calculation in the ATC Trajectory Planning and Management systems.

3.1.5.8.1 Flight Level value (CFL, NFL, AFL).

[REQ]

Identifier	REQ-10.02.01-TS-0006.0010
Requirement	The system shall calculate the Tactical Trajectory if track data and CFL or track data and NFL are available.
Title	Conditions for calculation of Tactical Trajectory
Status	<In Progress>
Rationale	It's necessary to know the candidate flights for tactical trajectory calculation.
Category	<Functional>
Verification Method	<Test>
Validation Method	

[REQ Trace]

Relationship	Linked Element Type	Identifier	Compliance
<ALLOCATED TO>	<Functional block>	Trajectory Prediction & Mgt (TP&M)	N/A
<SATISFIES>	<Enabler>	ER APP ATC 100a/b/c	<Full>
<SATISFIES>	<ATMS Requirement>	REQ-04.07.02-SPR-CDR1.1020	<Full>
<SATISFIES>	<ATMS Requirement>	REQ-04.07.02-OSED-0001.2041	<Full>

founding members



Avenue de Cortenbergh 100 | B -1000 Bruxelles
www.sesarju.eu

[REQ]

Identifier	REQ-10.02.01-TS-0006.0020
Requirement	The system shall assign for each aircraft a valid Cleared Flight Level (CFL) basing in the flight plan data.
Title	CFL assignment
Status	<In Progress>
Rationale	For trajectory calculation it is necessary that each flight has an assigned CFL.
Category	<Functional>
Verification Method	<Test>
Validation Method	

[REQ Trace]

Relationship	Linked Element Type	Identifier	Compliance
<ALLOCATED TO>	<Functional block>	Trajectory Prediction & Mgt (TP&M)	N/A
<SATISFIES>	<Enabler>	ER APP ATC 100a/b/c	<Full>
<SATISFIES>	<ATMS Requirement>	REQ-04.07.02-OSED-0001.3089	<Partial>

[REQ]

Identifier	REQ-10.02.01-TS-0006.0030
Requirement	The system shall assign for each aircraft the Entry Flight Level (NFL) of the first controlled sector in case of not valid CFL is available.
Title	NFL assignment
Status	<In Progress>
Rationale	If not valid CFL is available, the assigned NFL is necessary and will be used in the trajectory calculation.
Category	<Functional>
Verification Method	<Test>
Validation Method	

[REQ Trace]

Relationship	Linked Element Type	Identifier	Compliance
<ALLOCATED TO>	<Functional block>	Trajectory Prediction & Mgt (TP&M)	N/A
<SATISFIES>	<Enabler>	ER APP ATC 100a/b/c	<Full>
<SATISFIES>	<ATMS Requirement>	REQ-04.07.02-SPR-CDR1.1030	<Partial>
<SATISFIES>	<ATMS Requirement>	REQ-04.07.02-OSED-0001.3089	<Partial>

[REQ]

Identifier	REQ-10.02.01-TS-0006.0040
Requirement	The system shall mark as cancelled a cleared vertical rate when the difference between AFL and CFL is less than a threshold.
Title	Cleared vertical rate cancelled.
Status	<In Progress>
Rationale	If a vertical rate clearance hasn't validity, it can trigger safety critical situations and infringement of vertical separation.
Category	<Functional>
Verification Method	<Test>
Validation Method	

[REQ Trace]

Relationship	Linked Element Type	Identifier	Compliance
<ALLOCATED TO>	<Functional block>	Trajectory Prediction & Mgt (TP&M)	N/A
<SATISFIES>	<Enabler>	ER APP ATC 100a/b/c	<Full>
<SATISFIES>	<ATMS Requirement>	REQ-04.07.02-OSED-0001.3090	<Full>

founding members



Avenue de Cortenbergh 100 | B -1000 Bruxelles
www.sesarju.eu

3.1.5.8.2 Lateral/Vertical Trajectory

[REQ]

Identifier	REQ-10.02.01-TS-0006.0050
Requirement	The system shall calculate the vertical part of the tactical trajectory if none vertical deviation has been detected by FPM based on the actual rate (or cleared rate if available) plus a rate buffer if the aircraft moves towards the CFL.
Title	Vertical tactical trajectory calculation.
Status	<In Progress>
Rationale	If the aircraft is still at level a minimum and maximum rate shall be used instead. When the CFL is reached, cleared vertical rate shouldn't be taken into account.
Category	<Functional>
Verification Method	<Test>
Validation Method	

[REQ Trace]

Relationship	Linked Element Type	Identifier	Compliance
<ALLOCATED TO>	<Functional block>	Trajectory Prediction & Mgt (TP&M)	N/A
<SATISFIES>	<Enabler>	ER APP ATC 100a/b/c	<Full>
<SATISFIES>	<ATMS Requirement>	REQ-04.07.02-OSED-0001.3011	<Full>

[REQ]

Identifier	REQ-10.02.01-TS-0006.0060
Requirement	The lateral part of the tactical trajectory shall be calculated if none lateral deviation has been detected by FPM: a) NO LATERAL CLEARANCE. b) OPEN HEADING. c) DIRECT.
Title	Lateral trajectory calculation.
Status	<In Progress>
Rationale	These conditions are supposed for the calculation of the lateral trajectory: a) NO LATERAL CLEARANCE: along the cleared route to the clearance limit; b) OPEN HEADING: to extrapolated lat/long position based on the cleared heading which can be reached within time horizon. c) DIRECT: to the cleared fix, and then along the cleared route to the clearance limit.
Category	<Functional>
Verification Method	<Test>
Validation Method	

[REQ Trace]

Relationship	Linked Element Type	Identifier	Compliance
<ALLOCATED TO>	<Functional block>	Trajectory Prediction & Mgt (TP&M)	N/A
<SATISFIES>	<Enabler>	ER APP ATC 100a/b/c	<Full>
<SATISFIES>	<ATMS Requirement>	REQ-04.07.02-OSED-0001.3093	<Full>

[REQ]

Identifier	REQ-10.02.01-TS-0006.0070
Requirement	If a vertical rate deviation has been detected (no CFL deviation is detected at the same time) the system shall calculate the vertical part of the tactical

Founding members



Avenue de Cortenbergh 100 | B -1000 Bruxelles
www.sesarju.eu

	deviation trajectory based on the actual rate plus a rate buffer if the aircraft moves towards the CFL.
Title	Prediction of vertical trajectory after a rate deviation.
Status	<In Progress>
Rationale	If the aircraft is still at level, a minimum and maximum rate shall be used. The speed and altitude change of the aircraft shall be calculated basing on: a) the actual rate from AFL to CFL if the aircraft climbs/descends towards the CFL, b) a nominal vertical rate from AFL to CFL if the actual rate is zero (aircraft still level). The actual rate shall be derived from downlinked Mode S DAP if available.
Category	<Functional>
Verification Method	<Test>
Validation Method	

[REQ Trace]

Relationship	Linked Element Type	Identifier	Compliance
<ALLOCATED_TO>	<Functional block>	Trajectory Prediction & Mgt (TP&M)	N/A
<SATISFIES>	<Enabler>	ER APP ATC 100a/b/c	<Full>
<SATISFIES>	<ATMS Requirement>	REQ-04.07.02-OSED-0001.3011	<Full>

[REQ]

Identifier	REQ-10.02.01-TS-0006.0080
Requirement	If a CFL deviation has been detected the system shall calculate the vertical part of the tactical deviation trajectory based on the actual rate plus a rate buffer.
Title	Prediction of vertical trajectory after a CFL deviation.
Status	<In Progress>
Rationale	The speed and altitude change of the aircraft shall be based on the actual climb or descent rate from the AFL to a maximum or minimum flight level.
Category	<Functional>
Verification Method	<Test>
Validation Method	

[REQ Trace]

Relationship	Linked Element Type	Identifier	Compliance
<ALLOCATED_TO>	<Functional block>	Trajectory Prediction & Mgt (TP&M)	N/A
<SATISFIES>	<Enabler>	ER APP ATC 100a/b/c	<Full>
<SATISFIES>	<ATMS Requirement>	REQ-04.07.02-OSED-0001.3011	<Full>
<SATISFIES>	<ATMS Requirement>	REQ-04.07.02-OSED-0001.3012	<Full>

[REQ]

Identifier	REQ-10.02.01-TS-0006.0090
Requirement	The system shall calculate the lateral part of the deviation trajectory from the current track position of the aircraft to the extrapolated lat/long positions based on the current track and ground speed within a time horizon if a lateral deviation has been detected (Not considering Tactical Tajejectory)
Title	Prediction of lateral trajectory after lateral deviation
Status	<In Progress>
Rationale	In case of lateral deviation the trajectory shall be limited because it is expected that the aircraft returns to the cleared route in due time.
Category	<Functional>
Verification Method	<Test>
Validation Method	

founding members



Avenue de Cortenbergh 100 | B -1000 Bruxelles
www.sesarju.eu

[REQ Trace]

Relationship	Linked Element Type	Identifier	Compliance
<ALLOCATED_TO>	<Functional block>	Trajectory Prediction & Mgt (TP&M)	N/A
<SATISFIES>	<Enabler>	ER APP ATC 100a/b/c	<Full>
<SATISFIES>	<ATMS Requirement>	REQ-04.07.02-OSED-0001.3010	<Full>

[REQ]

Identifier	REQ-10.02.01-TS-0006.0100
Requirement	The system shall maintain constant and equal to the Entry Flight level (NFL the vertical part of an Entry Coordination Trajectory from the beginning to the end of the sector.
Title	Vertical part of an Entry Trajectory
Status	<In Progress>
Rationale	When a Entry flight Level is agreed and assigned to an aircraft before entering a sector, this level will be maintain during all the time that the aircraft will be into the sector.
Category	<Functional>
Verification Method	<Test>
Validation Method	

[REQ Trace]

Relationship	Linked Element Type	Identifier	Compliance
<ALLOCATED_TO>	<Functional block>	Trajectory Prediction & Mgt (TP&M)	N/A
<SATISFIES>	<Enabler>	ER APP ATC 100a/b/c	<Full>
<SATISFIES>	<ATMS Requirement>	REQ-04.07.02-OSED-0001.3099	<Full>

3.1.5.8.3 Tactical Trajectory

[REQ]

Identifier	REQ-10.02.01-TS-0006.0115
Requirement	Any new clearance shall lead to the re-computation of the tactical trajectory.
Title	Clearances leading to the tactical trajectory update
Status	<In Progress>
Rationale	Turn time shall be used for calculation of lateral latency time (refer to Trajectory Calculation) dependent on the difference between actual track and cleared track if the aircraft moves into the direction of the cleared track. Note: The reaction time can be configured to establish the adequate value means a VPS (Variable Parameter System)
Category	<Functional>
Verification Method	<Test>
Validation Method	

[REQ Trace]

Relationship	Linked Element Type	Identifier	Compliance
<ALLOCATED_TO>	<Functional block>	Trajectory Prediction & Mgt (TP&M)	N/A
<SATISFIES>	<Enabler>	ER APP ATC 100a/b/c	<Full>
<SATISFIES>	<ATMS Requirement>	REQ-04.07.02-SPR-CDR1.1040	<Full>

[REQ]

Identifier	REQ-10.02.01-TS-0006.0120
Requirement	The system shall take into account the reaction time of controller and pilot after a lateral clearance, in order to calculate the tactical trajectory during trajectory prediction process.
Title	Reaction time of controller and pilot after lateral clearance.
Status	<In Progress>

founding members



Avenue de Cortenbergh 100 | B -1000 Bruxelles
www.sesarju.eu

76 of 97

Rationale	Turn time shall be used for calculation of lateral latency time (refer to Trajectory Calculation) dependent on the difference between actual track and cleared track if the aircraft moves into the direction of the cleared track. Note: The reaction time can be configured to establish the adequate value means a VPS (Variable Parameter System)
Category	<Functional>
Verification Method	<Test>
Validation Method	

[REQ Trace]

Relationship	Linked Element Type	Identifier	Compliance
<ALLOCATED TO>	<Functional block>	Trajectory Prediction & Mgt (TP&M)	N/A
<SATISFIES>	<Enabler>	ER APP ATC 100a/b/c	<Full>
<SATISFIES>	<ATMS Requirement>	REQ-04.07.02-SPR-CDR1.1100	<Full>
<SATISFIES>	<ATMS Requirement>	REQ-04.07.02-OSED-0001.3091	<Full>

3.1.5.8.4 Open Heading

[REQ]

Identifier	REQ-10.02.01-TS-0006.0130
Requirement	The computation of the tactical trajectory shall take wind data into account when determining the actual ground path of an open heading.
Title	Wind data affecting open heading.
Status	<In Progress>
Rationale	The wind data influences the trajectory progress of aircraft, differing from its planned trajectory. Taking into account the wind data improves accuracy of CD& R.
Category	<Functional>
Verification Method	<Test>
Validation Method	

[REQ Trace]

Relationship	Linked Element Type	Identifier	Compliance
<ALLOCATED TO>	<Functional block>	Trajectory Prediction & Mgt (TP&M)	N/A
<SATISFIES>	<Enabler>	ER APP ATC 100a/b/c	<Full>
<SATISFIES>	<ATMS Requirement>	REQ-04.07.02-OSED-0001.3008	<Full>

3.1.5.8.5 Deviation Trajectory

[REQ]

Identifier	REQ-10.02.01-TS-0006.0140
Requirement	The system shall calculate a Deviation Trajectory when conformance monitoring functions detect that the aircraft is behaving in a manner outside of what is expected.
Title	Deviation Trajectory calculation.
Status	<In Progress>
Rationale	The not expecting behaviour may be caused by: <ul style="list-style-type: none"> a) Vertical rate deviation; b) Route deviation; c) Speed deviation; d) Cleared flight level (CFL) deviation; e) No valid flight plan data
Category	<Functional>
Verification Method	<Test>
Validation Method	

[REQ Trace]

Relationship	Linked Element Type	Identifier	Compliance
<ALLOCATED_TO>	<Functional block>	Trajectory Prediction & Mgt (TP&M)	N/A
<SATISFIES>	<Enabler>	ER APP ATC 101	<Full>
<SATISFIES>	<ATMS Requirement>	REQ-04.07.02-SPR-CDR1.1120	<Full>
<SATISFIES>	<ATMS Requirement>	REQ-04.07.02-SPR-CDR1.1130	<Full>
<SATISFIES>	<ATMS Requirement>	REQ-04.07.02-SPR-CDR1.1140	<Full>
<SATISFIES>	<ATMS Requirement>	REQ-04.07.02-SPR-CDR1.1150	<Full>
<SATISFIES>	<ATMS Requirement>	REQ-04.07.02-SPR-CDR1.1160	<Full>
<SATISFIES>	<ATMS Requirement>	REQ-04.07.02-SPR-CDR1.1170	<Full>
<SATISFIES>	<ATMS Requirement>	REQ-04.07.02-OSED-0001.2004	<Full>

3.1.5.8.6 Aircraft separation

[REQ]

Identifier	REQ-10.02.01-TS-0006.0150
Requirement	The system shall be able to detect situations where an aircraft is predicted to be below the applicable separation of interest with respect to another aircraft, or a designated volume of airspace, classified respectively as "aircraft-to-aircraft" and "aircraft-to-airspace" encounters.
Title	"Aircraft-to-aircraft" and "aircraft-to-airspace" encounters.
Status	<in progress>
Rationale	The separation of interest is the proximity of a pair of aircraft is considered to be of interest to a controller, for the airspace and conditions concerned. Particular instances of the Separation of Interest may be applied for each level of separation activity. The actual separation values used will take into account aspects such as the type of clearance issued, the requested navigation precision and the airspace rules.
Category	<Functional>
Verification Method	<Test>
Validation Method	

[REQ Trace]

Relationship	Linked Element Type	Identifier	Compliance
founding members			



<ALLOCATED_TO>	<Functional block>	Trajectory Prediction & Mgt (TP&M)	N/A
<SATISFIES>	<Enabler>	ER APP ATC 100a/b/c	<Full>
<SATISFIES>	<ATMS Requirement>	REQ-04.07.02-OSED-0001.3032	<Full>

3.1.5.8.7 What-if and What-else probing processes

[REQ]

Identifier	REQ-10.02.01-TS-0006.0160
Requirement	The system shall calculate the tactical what-if and what-else trajectories on request
Title	What-if and a What-else probing
Status	<In Progress>
Rationale	Tentative and Speculative trajectories are derived from what-if and what-else probing respectively, and they are calculated only on request.
Category	<Functional>
Verification Method	<Test>
Validation Method	

[REQ Trace]

Relationship	Linked Element Type	Identifier	Compliance
<ALLOCATED_TO>	<Functional block>	Trajectory Prediction & Mgt (TP&M)	N/A
<SATISFIES>	<Enabler>	ER APP ATC 100a/b/c	<Full>
<SATISFIES>	<ATMS Requirement>	REQ-04.07.02-SPR-CDR1.1230	<Full>
<SATISFIES>	<ATMS Requirement>	REQ-04.07.02-SPR-CDR1.1290	<Full>
<SATISFIES>	<ATMS Requirement>	REQ-04.07.02-OSED-0001.3038	<Full>

[REQ]

Identifier	REQ-10.02.01-TS-0006.0190
Requirement	The system shall calculate the following tactical what-else trajectories at each track update for all aircraft: a) Level clearances including rates (all suitable level clearances multiplied by number of vertical rates); b) Direct clearances - for fixes on route and off route. c) Open heading/track clearances (relative Heading clearances in steps).
Title	What-else probes calculation.
Status	<In Progress>
Rationale	The What-else calculation ensures that the system takes into account all the possible solutions immediately.
Category	<Functional>
Verification Method	<Test>
Validation Method	

[REQ Trace]

Relationship	Linked Element Type	Identifier	Compliance
<ALLOCATED_TO>	<Functional block>	Trajectory Prediction & Mgt (TP&M)	N/A
<SATISFIES>	<Enabler>	ER APP ATC 100a/b/c	<Full>
<SATISFIES>	<ATMS Requirement>	REQ-04.07.02-OSED-0001.4009	<Full>

[REQ]

Identifier	REQ-10.02.01-TS-0006.0210
Requirement	The system shall calculate the What-else tactical trajectory based on the same requirements as for Entry Trajectory calculation.
Title	What-else probing computation.

founding members



Avenue de Cortenbergh 100 | B -1000 Bruxelles
www.sesarju.eu

79 of 97

Status	<In Progress>
Rationale	In the what-else probing process, several Speculative Trajectories and associated data arising from What-If Probing are assessed for the impact on the occurrence of predicted Encounters.
Category	<Functional>
Verification Method	<Test>
Validation Method	

[REQ Trace]

Relationship	Linked Element Type	Identifier	Compliance
<ALLOCATED_TO>	<Functional block>	Trajectory Prediction & Mgt (TP&M)	N/A
<SATISFIES>	<Enabler>	ER APP ATC 100a/b/c	<Full>
<SATISFIES>	<ATMS Requirement>	REQ-04.07.02-OSED-0001.2036	<Full>

[REQ]

Identifier	REQ-10.02.01-TS-0006.0220
Requirement	The system shall use the Entry Flight Level within a configurable look ahead time in the computation of the What-else tactical trajectory. .
Title	What-else probing computation.
Status	<In Progress>
Rationale	When a what-else tactical trajectory is calculated exists a period of time, look ahead time, in which the Entry Flight level is defined and it must be used while the course of this period.
Category	<Functional>
Verification Method	<Test>
Validation Method	

[REQ Trace]

Relationship	Linked Element Type	Identifier	Compliance
<ALLOCATED_TO>	<Functional block>	Trajectory Prediction & Mgt (TP&M)	N/A
<SATISFIES>	<Enabler>	ER APP ATC 100a/b/c	<Full>
<SATISFIES>	<ATMS Requirement>	REQ-04.07.02-OSED-0001.3106	<Full>

3.1.5.8.8 Entry Trajectory

[REQ]

Identifier	REQ-10.02.01-TS-0006.0230
Requirement	The system shall calculate the Entry Trajectory for flights that have been coordinated but not yet entered the sector.
Title	Conditions for the Entry Trajectory Calculation.
Status	<Validated>
Rationale	Conditions which cause that An Entry Trajectory is not calculated: a) Flight Path Monitoring (FPM) has detected a NoTT or lateral route deviation b) a lateral open heading or off-route direct clearance has been issued.
Category	<Functional>
Verification Method	<Test>
Validation Method	

[REQ Trace]

Relationship	Linked Element Type	Identifier	Compliance
<ALLOCATED_TO>	<Functional block>	Trajectory Prediction & Mgt (TP&M)	N/A
<SATISFIES>	<Enabler>	ER APP ATC 100a/b/c	<Full>
<SATISFIES>	<ATMS Requirement>	REQ-04.07.02-OSED-0001.2034	<Full>

founding members



Avenue de Cortenbergh 100 | B -1000 Bruxelles
www.sesarju.eu

80 of 97

[REQ]

Identifier	REQ-10.02.01-TS-0006.0240
Requirement	The creation of the tactical entry trajectory shall be done if no lateral clearance had been issued, the lateral part of the Entry Trajectory shall be created from the current track position of the aircraft following its cleared route to the clearance limit.
Title	Lateral part of an Entry Trajectory in absence of lateral clearance
Status	<In Progress>
Rationale	The lateral part is identical to the Tactical Trajectory.
Category	<Functional>
Verification Method	<Test>
Validation Method	

[REQ Trace]

Relationship	Linked Element Type	Identifier	Compliance
<ALLOCATED TO>	<Functional block>	Trajectory Prediction & Mgt (TP&M)	N/A
<SATISFIES>	<Enabler>	ER APP ATC 100a/b/c	<Full>
<SATISFIES>	<ATMS Requirement>	REQ-04.07.02-OSED-0001.3095	<Full>

[REQ]

Identifier	REQ-10.02.01-TS-0006.0250
Requirement	The creation of the tactical entry trajectory shall be done if an on route direct clearance has been issued, the lateral part of the Entry Trajectory shall be created from the current track position to the direct waypoint and thereafter following the aircraft cleared route to the clearance limit.
Title	Lateral part of an Entry Trajectory in case of route direct clearance
Status	<In Progress>
Rationale	The lateral part is identical to the Tactical Trajectory.
Category	<Functional>
Verification Method	<Test>
Validation Method	

[REQ Trace]

Relationship	Linked Element Type	Identifier	Compliance
<ALLOCATED TO>	<Functional block>	Trajectory Prediction & Mgt (TP&M)	N/A
<SATISFIES>	<Enabler>	ER APP ATC 100a/b/c	<Full>
<SATISFIES>	<ATMS Requirement>	REQ-04.07.02-OSED-0001.3095	<Full>

[REQ]

Identifier	REQ-10.02.01-TS-0006.0260
Requirement	The system shall terminate an entry trajectory at the Initial Approach Fix.
Title	Entry Trajectory Scope.
Status	<in progress>
Rationale	The IAF is the limit point to consider an entry trajectory. From here the flight is already beginning the final descent prior to landing phase, so the entry trajectory is not involved at this phase.
Category	<Functional>
Verification Method	<Test>
Validation Method	

[REQ Trace]

Relationship	Linked Element Type	Identifier	Compliance
<ALLOCATED TO>	<Functional block>	Trajectory Prediction & Mgt (TP&M)	N/A

founding members



Avenue de Cortenbergh 100 | B -1000 Bruxelles
www.sesarju.eu

<SATISFIES>	<Enabler>	ER APP ATC 100a/b/c	<Full>
<SATISFIES>	<ATMS Requirement>	REQ-04.07.02-OSED-0001.3100	<Full>

3.1.5.8.9 Speed prediction

[REQ]

Identifier	REQ-10.02.01-TS-0006.0270
Requirement	The computation of the tactical entry trajectory shall use the tactical trajectory current ground speed taking into account the expected speed change with altitude, i.e. constant CAS/constant Mach.
Title	Speed in an Entry Trajectory.
Status	<In Progress>
Rationale	Constant acceleration shall be assumed for the expected speed increase/decrease with increasing/decreasing altitude
Category	<Functional>
Verification Method	<Test>
Validation Method	

[REQ Trace]

Relationship	Linked Element Type	Identifier	Compliance
<ALLOCATED TO>	<Functional block>	Trajectory Prediction & Mgt (TP&M)	N/A
<SATISFIES>	<Enabler>	ER APP ATC 100a/b/c	<Full>
<SATISFIES>	<ATMS Requirement>	REQ-04.07.02-OSED-0001.4052	<Full>

[REQ]

Identifier	REQ-10.02.01-TS-0006.0280
Requirement	The computation of the tactical entry trajectory shall use the speed change of the aircraft and the sector entry times of the Entry Trajectory based on following assumptions: a) Initial FL is the AFL (or CFL if a clearance is still active) in the current sector and the NFL in all following sectors respectively b) Final FL is the NFL of the next sector entry point c) For speed changes a nominal vertical rate PV feet/minute shall be assumed d) If the sector entry FL is below the sector exit FL the climb shall start as soon as possible e) If the sector entry FL is above the sector exit FL the descent shall start as late as possible.
Title	Speed part of Entry Trajectory
Status	<In Progress>
Rationale	The speed increase/decrease with changing altitude will be modelled in order to improve the estimated time over for the waypoints of the trajectory. The altitudes for the modeling of the speed changes need not match the altitudes contained in the trajectory. This design has been chosen, because the speed increase/decrease follows the most probable flight performance whereas the vertical behavior assumes the co-ordinated sector entry throughout the whole sector.
Category	<Functional>
Verification Method	<Test>
Validation Method	

[REQ Trace]

Relationship	Linked Element Type	Identifier	Compliance
<ALLOCATED TO>	<Functional block>	Trajectory Prediction & Mgt (TP&M)	N/A

founding members



Avenue de Cortenbergh 100 | B -1000 Bruxelles
www.sesarju.eu

82 of 97

<SATISFIES>	<Enabler>	ER APP ATC 100a/b/c	<Full>
<SATISFIES>	<ATMS Requirement>	REQ-04.07.02-OSED-0001.4052	<Full>

[REQ]

Identifier	REQ-10.02.01-TS-0006.0290
Requirement	The system shall calculate the speed and altitude change of an aircraft basing on: a) the actual rate (cleared rate if available) from AFL to CFL if the aircraft climbs or descends towards the CFL, b) a nominal vertical rate from AFL to CFL if the actual rate is zero.
Title	Speed and altitude change calculation.
Status	<Validated>
Rationale	Depending on de actual rate or the movement of the aircraft towards the CFL the reference rate to calculate speed and altitude will be different.
Category	<Functional>
Verification Method	<Test>
Validation Method	

[REQ Trace]

Relationship	Linked Element Type	Identifier	Compliance
<ALLOCATED_TO>	<Functional block>	Trajectory Prediction & Mgt (TP&M)	N/A
<SATISFIES>	<Enabler>	ER APP ATC 100a/b/c	<Full>
<SATISFIES>	<ATMS Requirement>	REQ-04.07.02-OSED-0001.3112	<Full>

[REQ]

Identifier	REQ-10.02.01-TS-0006.0300
Requirement	The computation of the tactical trajectory shall use the speed of an aircraft based on the ground speed, taking into account the expected speed change at a different altitude
Title	Ground speed prediction.
Status	<In Progress>
Rationale	Take into account that a constant acceleration shall be assumed for the expected increase/decrease with increasing/decreasing altitude.
Category	<Functional>
Verification Method	<Test>
Validation Method	

[REQ Trace]

Relationship	Linked Element Type	Identifier	Compliance
<ALLOCATED_TO>	<Functional block>	Trajectory Prediction & Mgt (TP&M)	N/A
<SATISFIES>	<Enabler>	ER APP ATC 100a/b/c	<Full>
<SATISFIES>	<ATMS Requirement>	REQ-04.07.02-OSED-0001.3007	<Full>

3.1.5.8.10 Tentative Trajectory

[REQ]

Identifier	REQ-10.02.01-TS-0006.0340
Requirement	What-if planned trajectories based on controller tentative coordination data shall be calculated on request
Title	Tentative trajectories from another trajectory
Status	<Validated>
Rationale	Tentative trajectories are used in What-ifs.
Category	<Functional>
Verification Method	<Test>
Validation Method	

founding members



Avenue de Cortenbergh 100 | B -1000 Bruxelles
www.sesarju.eu

83 of 97

[REQ Trace]

Relationship	Linked Element Type	Identifier	Compliance
<ALLOCATED TO>	<Functional block>	Trajectory Prediction & Mgt (TP&M)	N/A
<SATISFIES>	<Enabler>	ER APP ATC 100a/b/c	<Full>
<SATISFIES>	<ATMS Requirement>	REQ-04.07.02-OSED-0002.3076	<Full>

[REQ]

Identifier	REQ-10.02.01-TS-0006.0350
Requirement	What-else planned trajectories based on system speculative coordination data shall be calculated on request
Title	Speculative Trajectory from another trajectory
Status	<In Progress>
Rationale	Speculative trajectories are used in What-Elses.
Category	<Functional>
Verification Method	<Test>
Validation Method	

[REQ Trace]

Relationship	Linked Element Type	Identifier	Compliance
<ALLOCATED TO>	<Functional block>	Trajectory Prediction & Mgt (TP&M)	N/A
<SATISFIES>	<Enabler>	ER APP ATC 100a/b/c	<Full>
<SATISFIES>	<ATMS Requirement>	REQ-04.07.02-OSED-0002.3077	<Full>

[REQ]

Identifier	REQ-10.02.01-TS-0006.0360
Requirement	The context trajectory generated by the system shall follow the lateral profile of the Planned Trajectory.
Title	Context trajectory after lateral profile
Status	<Validated>
Rationale	Each Context Trajectory maintains a single level following the lateral profile of the Planned Trajectory.
Category	<Functional>
Verification Method	<Test>
Validation Method	

[REQ Trace]

Relationship	Linked Element Type	Identifier	Compliance
<ALLOCATED TO>	<Functional block>	Trajectory Prediction & Mgt (TP&M)	N/A
<SATISFIES>	<Enabler>	ER APP ATC 100a/b/c	<Full>
<SATISFIES>	<ATMS Requirement>	REQ-04.07.02-OSED-0002.4045	<Partial>

[REQ]

Identifier	REQ-10.02.01-TS-0006.0370
Requirement	The context trajectory generated by the system shall be updated with the lateral changes to the initial cleared route.
Title	Updating of context trajectory
Status	<Validated>
Rationale	Unlike planner coordination trajectories, context trajectories shall not subscribe to coordination constraints (heading or route and/or speed).
Category	<Functional>
Verification Method	<Test>
Validation Method	

[REQ Trace]

founding members



Avenue de Cortenbergh 100 | B -1000 Bruxelles
www.sesarju.eu

Relationship	Linked Element Type	Identifier	Compliance
<ALLOCATED_TO>	<Functional block>	Trajectory Prediction & Mgt (TP&M)	N/A
<SATISFIES>	<Enabler>	ER APP ATC 100a/b/c	<Full>
<SATISFIES>	<ATMS Requirement>	REQ-04.07.02-OSED-0002.4045	<Partial>

[REQ]

Identifier	REQ-10.02.01-TS-0006.0380
Requirement	The system shall generate Context Trajectories which are built at every standard Flight Level from the entry-context level to the exit-context level.
Title	Context Trajectories Generation
Status	<in progress>
Rationale	The identification of entry-context and exit-context levels is dictated by the information available in the system at the time of the probe. The range of trajectories represents airspace occupancy in the planning-sector.
Category	<Functional>
Verification Method	<Test>
Validation Method	

[REQ Trace]

Relationship	Linked Element Type	Identifier	Compliance
<ALLOCATED_TO>	<Functional block>	Trajectory Prediction & Mgt (TP&M)	N/A
<SATISFIES>	<Enabler>	ER APP ATC 100a/b/c	<Full>
<SATISFIES>	<ATMS Requirement>	REQ-04.07.02-OSED-0002.4046	<Full>

[REQ]

Identifier	REQ-10.02.01-TS-0006.0390
Requirement	The system shall identifies as “Planner Context Flights” the flights involved in Context Encounters.
Title	Planner Context Flights
Status	<Validated>
Rationale	Context Encounters are detected between Context Trajectories. There is only one separation threshold, “Context Separation”, and therefore no such concept as a “Context Conflict”
Category	<Functional>
Verification Method	<Test>
Validation Method	

[REQ Trace]

Relationship	Linked Element Type	Identifier	Compliance
<ALLOCATED_TO>	<Functional block>	Trajectory Prediction & Mgt (TP&M)	N/A
<SATISFIES>	<Enabler>	ER APP ATC 100a/b/c	<Full>
<SATISFIES>	<ATMS Requirement>	REQ-04.07.02-OSED-0002.3110	<Full>

[REQ]

Identifier	REQ-10.02.01-TS-0006.0410
Requirement	The system shall monitor the deviations from each flight’s entry and exit coordination conditions.
Title	Monitoring of deviations.
Status	<Validated>
Rationale	If deviations of the aircraft from the planning or tactical trajectory are monitored and detected by the ATC system are detected as early as possible the controller can react quickly and resolve them.
Category	<Functional>
Verification Method	<Test>
Validation Method	

founding members



Avenue de Cortenbergh 100 | B -1000 Bruxelles
www.sesarju.eu

85 of 97

[REQ Trace]

Relationship	Linked Element Type	Identifier	Compliance
<ALLOCATED TO>	<Functional block>	Trajectory Prediction & Mgt (TP&M)	N/A
<SATISFIES>	<Enabler>	ER APP ATC 100a/b/c	<Full>
<SATISFIES>	<ATMS Requirement>	REQ-04.07.02-OSED-0002.3053	<Full>

[REQ]

Identifier	REQ-10.02.01-TS-0006.0420
Requirement	The system shall calculate the suitability of sector entry and exit conditions for an aircraft involved in possible encounters in this area.
Title	Entry and exit conditions.
Status	<Validated>
Rationale	Anticipating those encounters between crossing routes at the boundary between sectors, the suitability of sector entry and exit conditions can be determined more reliably.
Category	<Functional>
Verification Method	<Test>
Validation Method	

[REQ Trace]

Relationship	Linked Element Type	Identifier	Compliance
<ALLOCATED TO>	<Functional block>	Trajectory Prediction & Mgt (TP&M)	N/A
<SATISFIES>	<Enabler>	ER APP ATC 100a/b/c	<Full>
<SATISFIES>	<ATMS Requirement>	REQ-04.07.02-OSED-0002.3058	<Full>

[REQ]

Identifier	REQ-10.02.01-TS-0006.0430
Requirement	The system shall be able to alert the controller if any flight is not able to achieve the level associated with the sector entry/exit coordination built by the Coordination Trajectory.
Title	Alerting for entry/exit level not achievable.
Status	<Validated>
Rationale	Planner Controller needs to know if any flight is not able to achieve the level associated with the sector entry/exit coordination. Two solutions are presented: <ul style="list-style-type: none"> -Amend the coordinated level. -Request to the Tactical Controller, who has control of that flight, to take action to climb/descend the flight to the coordinated level.
Category	<Functional>
Verification Method	<Test>
Validation Method	

[REQ Trace]

Relationship	Linked Element Type	Identifier	Compliance
<ALLOCATED TO>	<Functional block>	Trajectory Prediction & Mgt (TP&M)	N/A
<SATISFIES>	<Enabler>	ER APP ATC 100a/b/c	<Full>
<SATISFIES>	<ATMS Requirement>	REQ-04.07.02-OSED-0002.4018	<Full>

founding members



Avenue de Cortenbergh 100 | B -1000 Bruxelles
www.sesarju.eu

86 of 97

3.1.5.8.11CTO Capability

[REQ]

Identifier	REQ-10.02.01-TS-0006.0450
Requirement	The time constraint given in the CTO instruction (i.e. on WILCO answer by the aircraft) shall be shared with adjacent ATSU's.
Title	CTO generation.
Status	<In Progress>
Rationale	It is important that the CTO is considered by all services of the Ground system, existing consistency between services,
Category	<Functional>
Verification Method	<Test>
Validation Method	

[REQ Trace]

Relationship	Linked Element Type	Identifier	Compliance
<ALLOCATED_TO>	<Functional block>	Trajectory Prediction & Mgt (TP&M)	N/A
<SATISFIES>	<Enabler>	ER APP ATC 100a/b/c	<Full>
<SATISFIES>	<ATMS Requirement>	REQ-04.07.02-OSED-0003.4027	<Full>

3.1.5.8.12Coordination Trajectories prediction

[REQ]

Identifier	REQ-10.02.01-TS-0006.0460
Requirement	The system shall calculate Coordination trajectories on request from the PC aid for each flight that either is expected to enter the sector, or is expected to enter the Area of Interest (if any), or is manually selected
Title	Coordination Trajectories.
Status	<in progress>
Rationale	If only is needed to calculate the coordination trajectory for a specific flight, this flight must be selected. In other case, in response on a request, all the coordination trajectories corresponding to interest flights will be calculated.
Category	<Functional>
Verification Method	<Test>
Validation Method	

[REQ Trace]

Relationship	Linked Element Type	Identifier	Compliance
<ALLOCATED_TO>	<Functional block>	Trajectory Prediction & Mgt (TP&M)	N/A
<SATISFIES>	<Enabler>	ER APP ATC 100a/b/c	<Full>
<SATISFIES>	<ATMS Requirement>	REQ-04.07.02-OSED-0002.3119	<Full>

[REQ]

Identifier	REQ-10.02.01-TS-0006.0470
Requirement	The system shall calculate Entry coordination trajectories on request from the planner in order to allow him/her to determine whether the level at which a flight is proposed to enter the sector is acceptable (i.e. safe).
Title	Entry Coordination Trajectories.
Status	<Validated>
Rationale	It's necessary the feasibility and security of the proposed level.
Category	<Functional>
Verification Method	<Test>
Validation Method	

founding members



Avenue de Cortenbergh 100 | B -1000 Bruxelles
www.sesarju.eu

[REQ Trace]

Relationship	Linked Element Type	Identifier	Compliance
<ALLOCATED TO>	<Functional block>	Trajectory Prediction & Mgt (TP&M)	N/A
<SATISFIES>	<Enabler>	ER APP ATC 100a/b/c	<Full>
<SATISFIES>	<ATMS Requirement>	REQ-04.07.02-OSED-0002.4054	<Full>

[REQ]

Identifier	REQ-10.02.01-TS-0006.0480
Requirement	The system shall calculate Exit coordination trajectories on request from the planner in order to allow him/her to determine if the level at which the flight is proposed to the next sector is suitable (i.e. achievable and safe).
Title	Exit Coordination Trajectories.
Status	<Validated>
Rationale	It's necessary the feasibility and security of the proposed level.
Category	<Functional>
Verification Method	<Test>
Validation Method	

[REQ Trace]

Relationship	Linked Element Type	Identifier	Compliance
<ALLOCATED TO>	<Functional block>	Trajectory Prediction & Mgt (TP&M)	N/A
<SATISFIES>	<Enabler>	ER APP ATC 100a/b/c	<Full>
<SATISFIES>	<ATMS Requirement>	REQ-04.07.02-OSED-0002.4055	<Full>

[REQ]

Identifier	REQ-10.02.01-TS-0006.0490
Requirement	In a coordination level (coordinated climb or descent) the system shall calculate Coordination trajectories for each standard flight level comprised between the constraint level and the target level inclusive.
Title	Range of Coordination Trajectories
Status	<In Progress>
Rationale	The Coordination Trajectories generated shall be comprised into a defined range.
Category	<functional>
Verification Method	<Test>
Validation Method	

[REQ Trace]

Relationship	Linked Element Type	Identifier	Compliance
<ALLOCATED TO>	<Functional block>	Trajectory Prediction & Mgt (TP&M)	N/A
<SATISFIES>	<Enabler>	ER APP ATC 100a/b/c	<Full>
<SATISFIES>	<ATMS Requirement>	REQ-04.07.02-OSED-0002.4056	<Full>

3.2 Performance Characteristics

Not Applicable - decisions to be taken by each individual industrial partner.

3.3 Safety & Security

None Applicable for step 1 prototypes as no specific safety or security aspects have been identified from the operational inputs.

3.4 Maintainability

Not Applicable - decisions to be taken by each individual industrial partner.

3.5 Reliability

Not Applicable - decisions to be taken by each individual industrial partner.

3.6 Functional Block Internal Data Requirements

Not Applicable - decisions to be taken by each individual industrial partner.

3.7 Design and Construction Constraints

Not Applicable - decisions to be taken by each individual industrial partner.

3.8 Functional block Interface Requirements

Not Applicable - decisions to be taken by each individual industrial partner.

founding members



Avenue de Cortenbergh 100 | B -1000 Bruxelles
www.sesarju.eu

89 of 97

4 Assumptions

N/A

founding members



Avenue de Cortenbergh 100 | B -1000 Bruxelles
www.sesarju.eu

90 of 97

5 References

- [1] Template Toolbox 03.00.00
<https://extranet.sesarju.eu/Programme%20Library/SESAR%20Template%20Toolbox.dot>
- [2] Requirements and V&V Guidelines 03.00.00
<https://extranet.sesarju.eu/Programme%20Library/Requirements%20and%20VV%20Guidelines.doc>
- [3] Templates and Toolbox User Manual 03.00.00
<https://extranet.sesarju.eu/Programme%20Library/Templates%20and%20Toolbox%20User%20Manual.doc>
- [4] EUROCONTROL ATM Lexicon
<https://extranet.eurocontrol.int/http://atmlexicon.eurocontrol.int/en/index.php/SESAR>
- [5] SESAR Definition Phase – Task 2.4.x Milestone 3 – System Architecture (DLT-0612-244-00-10), September 2007
- [6] IEEE / MIL Standards
- [7] The Roadmap for Delivering High Performing Aviation for Europe - European ATM Master Plan, Edition 2015 <https://www.atmmasterplan.eu/>
- [8] SESAR B04.03-D474, ADD Step 1, 2013 edition, version 00.01.13, 04/07/2014
- [9] SESAR 10.2.1 D72, High Level Trajectory Management Design for Release 2, version 00.01.02, 29/11/2012
- [10] SESAR 10.2.1 D73, Trajectory Management Step 1 Roadmap, version 00.01.04, 28/11/2012
- [11] EUROCONTROL/FAA action plan 16, Common TP Structure and Terminology in support of SESAR & NextGen, Version 1.0, January 29, 2010
- [12] SESAR 10.02.01 D74, ATC TM System Requirements step1, version 00.02.01, 01/08/2012
- [13] SESAR 04.07.03 OSED/SPR/INTEROP D02, version 00.03.05, April 2014
- [14] SESAR 05.05.01 OSED D01, version 00.03.00, February 2011
- [15] SESAR 05.06.01 OSED It3 D74, version 01.00.00, September 2013
- [16] SESAR 05.06.01 SPR It3 M196, version 00.01.00, April 2014
- [17] SESAR 05.06.01 Interop It3 M197, version 00.01.01, December 2013
- [18] SESAR 05.06.04 OSED D32, version 02.00.00, February 2014
- [19] SESAR 05.06.04 SPR D30, version 01.00.00, December 2013
- [20] SESAR 05.02 D101, Step1 Detailed Operational Description, version 00.01.00, October 2011
SESAR 10.01.07 D110, Technical Architecture Description - Cycle 2013, version 00.01.00, March 2014
- [21] SESAR 04.02 D98, Updated Step 1 ATC TM System Requirements - Cycle 3, version 00.06.03, December 2013
- [22] SESAR 04.07.02 OSED D19, version 02.00.00, November 2013
- [23] SESAR 04.07.02 OSED 3 D10, version 01.00.00, February 2015
- [24] SESAR 04.07.02 - SPR D020, version 00.01.01, November 2014
- [25] SESAR 05.06.04 Updated Step 1 ATC TM System Requirements - Cycle 3 D34 version April 2015
- [26] SESAR P10.01.07 D120 – Technical Architecture Document Cycle 5 – v00.01.00 – 03/02/2016
- [27] SESAR 10.09.02 - AMAN Step 1 Technical Specification, version 00.05.00
- [28] P5.5.1-D838-TMF-IOP co-ordination with OFA Report 2014 (16/03/2015)

founding members

Avenue de Cortenbergh 100 | B -1000 Bruxelles
www.sesarju.eu

91 of 97

- [29]P4.5 TMF-IOP Technical Note – Final (29/01/2016)
- [30]P4.7.2-D11-Safety and performance Requirements_3 (10/01/2016)
- [31]P5.5.1-D839-TMF-IOP co-ordination with OFA Report 2015 (15/12/2015)
- [32]P4.7.2 D22-Preliminary OSED 4 (15/01/2016)
- [33]P5.5.1/4.5 TMF-IOP co-ordination with OFA Report 2014 (16/03/2015)
- [34]P5.5.1/4.5 TMF-IOP co-ordination with OFA Report 2015 (09/12/2015)
- [35]P4.7.2 D30 - Preliminary Safety and Performance Requirements for MTCD/TCT_4 (30/11/2015)
- [36]P4.7.2 D60 - Preliminary Safety and Performance Requirements for TRACT_4 (30/11/2015)
- [37]P5.7.2 D77-Preliminary V2 OSED for Step 1 (30/05/2016)
- [38]5.7.2 D78-Preliminary V2 SPR for Step 1 (30/05/2016)
- [39]5.7.2 D79-Preliminary V2 INTEROP for Step 2 (30/05/2016)
- [40]10.01.07 D115 Technical Architecture Document (TAD) Cycle 4 (27/03/2015)
- [41]

5.1 Use of copyright / patent material /classified material

No copyrighted material has been used in the production of the specification.

5.2 Traceability

This section presents the traceability matrices, which identify, for every TS requirement:

The key elements of the TS requirement (identifier and title);

The functional block that the TS requirement is allocated to;

The higher level requirement that the TS requirement satisfies (identifier and title).

See attached file:



10.02.01-D88_SJU_
Assessment_report_f

Appendix A

The following requirements from 04.07.02-OSED have not been considered in the current release of the Technical Specification because they are considered as baseline and are not considered as new requirements for the project 10.02.01.

[REQ]

Identifier	REQ-10.02.01-TS-0006.0310
Requirement	The system shall predict the trajectory for each flight is in one of the following cases: <ul style="list-style-type: none"> • Flight expecting to enter in a sector. • Flight expecting to enter the Area of Interest.
Title	Trajectory prediction cases.
Status	<Deleted>
Rationale	For the flights in which the controller is interested the trajectory will be calculated.
Category	<Baseline>
Verification Method	<Test>
Validation Method	

[REQ Trace]

Relationship	Linked Element Type	Identifier	Compliance
<ALLOCATED_TO>	<Functional block>	Trajectory Prediction & Mgt (TP&M)	N/A
<SATISFIES>	<ATMS Requirement>	REQ-04.07.02-OSED-0002.2011	<Full>

[REQ]

Identifier	REQ-10.02.01-TS-0006.0400
Requirement	The system shall confirm than the entry and exit coordination for each aircraft was successful.
Title	Entry and exit coordination successful.
Status	<Deleted>
Rationale	Planner Controller needs to know if any flight is not able to achieve the level associated with the sector entry/exit coordination. Two solutions are presented: <ul style="list-style-type: none"> -Amend the coordinated level. -Request to the Tactical Controller, who has control of that flight, to takeaction to climb/descend the flight to the coordinated level.
Category	<Baseline>
Verification Method	<Test>
Validation Method	

[REQ Trace]

Relationship	Linked Element Type	Identifier	Compliance
<ALLOCATED_TO>	<Functional block>	Trajectory Prediction & Mgt (TP&M)	N/A
<SATISFIES>	<ATMS Requirement>	REQ-04.07.02-OSED-0002.2014	<Full>

[REQ]

Identifier	REQ-10.02.01-TS-0006.0440
Requirement	The system shall allow the addition of lateral constraints to sector entry and exit boundary coordination.
Title	Addition of lateral constraints.
Status	<Deleted>
Rationale	Lateral constraints are used by the PC to manage the presentation of flights into and out of the sector, helping the TC's task.

founding members



Avenue de Cortenbergh 100 | B -1000 Bruxelles
www.sesarju.eu

Category	<Baseline>
Verification Method	<Test>
Validation Method	

[REQ Trace]

Relationship	Linked Element Type	Identifier	Compliance
<ALLOCATED TO>	<Functional block>	Trajectory Prediction & Mgt (TP&M)	N/A
<SATISFIES>	<ATMS Requirement>	REQ-04.07.02-OSED-0002.4016	<Full>

founding members



Avenue de Cortenbergh 100 | B -1000 Bruxelles
www.sesarju.eu

94 of 97

Appendix B

The following requirements from 04.07.02-OSED was deleted because in accordance with the update of the OSED and are not considered as requirements for the project 10.02.01.

[REQ]

Identifier	REQ-10.02.01-TS-0006.0110
Requirement	The system shall calculate the Tactical Trajectory if no deviation occurred. In case of conformance monitoring functions detect that the aircraft is behaving in a manner outside of what is expected, a Deviation Trajectory is predicted.
Title	Tactical Trajectory vs Deviation Trajectory calculation.
Status	<Deleted>
Rationale	Depending on the deviation conditions the calculated trajectory shall be Tactical or Deviation.
Category	<Functional>
Verification Method	<Test>

[REQ Trace]

Relationship	Linked Element Type	Identifier	Compliance
<ALLOCATED TO>	<Functional block>	Trajectory Prediction & Mgt (TP&M)	N/A
<SATISFIES>	<ATMS Requirement>	REQ-04.07.02-OSED-0001.2033	<Full>

[REQ]

Identifier	REQ-10.02.01-TS-0006.0200
Requirement	The system shall calculate the following tactical what-if probes on request by the controller: a) Closed heading followed by an on route fix (re-join point) b) Direct clearances to fixes off route followed by a fix on the route (re-join point).
Title	What-if probes calculation.
Status	<Deleted>
Rationale	These What-if probes ensure that the system shows if the chosen controller solution for closed heading or Direct is conflict free or not.
Category	<Functional>
Verification Method	<Test>

[REQ Trace]

Relationship	Linked Element Type	Identifier	Compliance
<ALLOCATED TO>	<Functional block>	Trajectory Prediction & Mgt (TP&M)	N/A
<SATISFIES>	<ATMS Requirement>	REQ-04.07.02-OSED-0001.4010	<Full>

founding members



Avenue de Cortenbergh 100 | B -1000 Bruxelles
www.sesarju.eu

95 of 97

-

founding members



Avenue de Cortenbergh 100 | B -1000 Bruxelles
www.sesarju.eu

END OF DOCUMENT -

founding members



Avenue de Cortenbergh 100 | B -1000 Bruxelles
www.sesarju.eu