



Operational concept for the integration of the safety support tools: updated OCD (third year)

Document information

Project Title	Airport Safety Support Tools for Pilots, Vehicle Drivers and Controllers
Project Number	06.07.01
Project Manager	DSNA
Deliverable Name	Operational concept for the integration of the safety support tools: updated OCD (third year)
Deliverable ID	D05
Edition	00.01.03
Template Version	03.00.00

Task contributors

Airbus, DSNA, EUROCONTROL, NORACON, SEAC

Abstract

P06.07.01 and P09.14 develop and validate several "Airport Safety Support Services for Pilots, Vehicle Drivers and Controllers": "Runway Status Lights" (RWSL), "Detection of conflicting ATC clearances", "Conformance monitoring alerts for controllers", "Alerts for vehicle drivers", "Conformance monitoring alerts for pilots" and "Traffic alerts for pilots". These safety support tools will add themselves to the existing ones (A-SMGCS RMCA, Visual aids at runway entries and Surface traffic display to flight crews) and to the "Display of traffic on airport map to vehicle drivers". All these safety support tools are mostly designed independently of each other as they should be operable individually. Nevertheless, several of them can be simultaneously available to flight crews, vehicle drivers and controllers. Furthermore, in a given situation, some alerts can be generated to flight crews and/or vehicle drivers and/or controllers.

This document provides a description of the safety support tools addressed by P06.07.01 and P09.14, and it highlights the possible interactions and complementarities between them.

Document History

Edition	Date	Status	Author	Justification
00.00.01	12/01/2015	Draft	(see Prepared by)	First version of the document integrating the partners' contributions.
00.00.02	17/02/2015	Draft	(see Prepared by)	Second version of the document, integrating the outcome of the OCD WKS on 20/01/2015.
00.00.03	27/02/2015	Draft	(see Prepared by)	Update following internal P6.7.1 review
00.00.04	16/03/2015	Draft	(see Prepared by)	Update following external review. Distributed for approval.
00.01.00	30/03/2015	Final	(see Prepared by)	Approved version.
00.01.01	20/05/2015	Final	(see Prepared by)	Update following SJU assessment
00.01.02	09/09/2016	Final	DSNA	Minor Updates prior publication
00.01.03	07/11/2016	Final	██████████	Page footer updated and review marks removed

Intellectual Property Rights (foreground)

This deliverable consists of SJU foreground.

Table of Contents

EXECUTIVE SUMMARY	7
1 INTRODUCTION	9
1.1 PURPOSE OF THE DOCUMENT	9
1.2 INTENDED READERSHIP	10
1.3 INPUTS FROM OTHER PROJECTS	10
1.4 GLOSSARY OF TERMS	10
1.5 ACRONYMS.....	11
2 OPERATIONAL CONTEXT	14
2.1 OPERATIONAL ISSUES	14
2.1.1 <i>Runway incursions</i>	14
2.1.2 <i>Incidents on taxiways</i>	15
2.1.3 <i>Infringement of restricted or closed areas</i>	16
2.1.4 <i>Detection of conflicting ATC clearances</i>	16
2.1.5 <i>Non-conformance to ATC instructions or procedures</i>	16
2.2 EXISTING AIRPORT SAFETY SUPPORT TOOLS	17
2.2.1 <i>A-SMGCS Level 2</i>	17
2.2.2 <i>Visual aids at runway entries</i>	18
2.2.3 <i>Surface traffic display to flight crews (ATSA-SURF)</i>	19
2.2.4 <i>Alerting and surface traffic display for vehicle drivers</i>	19
3 GENERAL BENEFITS, PROBLEMS AND ASSUMPTIONS	20
3.1 OPERATIONAL BENEFITS	20
3.1.1 <i>General perspective</i>	20
3.1.2 <i>Controller perspective</i>	20
3.1.3 <i>Flight crew perspective</i>	20
3.1.4 <i>Vehicle driver perspective</i>	20
3.2 LEVELS OF ALERTS	21
3.2.1 <i>Flight crews</i>	21
3.2.2 <i>Controllers</i>	21
3.2.3 <i>Vehicle Drivers</i>	22
3.3 PROBLEMS AND RISKS	22
3.4 ASSUMPTIONS	22
4 NEW AIRPORT SAFETY SUPPORT TOOLS	24
4.1 OVERVIEW	24
4.1.1 <i>Runway Status Lights (RWSL)</i>	24
4.1.2 <i>Conformance Monitoring Alerts for Controllers (CMAC)</i>	25
4.1.3 <i>Conformance Monitoring Alerts for Pilots (CMAP)</i>	26
4.1.4 <i>Display of traffic on airport map to vehicle drivers</i>	27
4.1.5 <i>Alerts for vehicle drivers</i>	27
4.1.6 <i>Traffic alerts for flight crews</i>	28
4.2 SUMMARY	30
5 DESCRIPTION OF OPERATIONAL CONCEPTS	32
5.1 TOOLS FOR TOWER CONTROLLERS	32
5.1.1 <i>Prioritisation of Alerts</i>	32
5.1.2 <i>Conflicting ATC Clearances detection (CATC)</i>	32
5.1.3 <i>Conformance Monitoring Alerts for Controllers (CMAC)</i>	38
5.1.4 <i>Integration of safety support tools for controllers</i>	42
5.2 TOOLS FOR FLIGHT CREWS	44
5.2.1 <i>Runway Status Lights (RWSL)</i>	44
5.2.2 <i>Conformance monitoring alerts for flight crews</i>	47
5.2.3 <i>Traffic alerts for flight crews</i>	53

5.2.4	Integration of safety support tools for flight crews.....	59
5.3	TOOLS FOR VEHICLE DRIVERS	61
5.3.1	Runway Status Lights (RWSL).....	61
5.3.2	Traffic alerts for vehicle drivers.....	61
5.3.3	Area infringement alerts for vehicle drivers.....	66
5.3.4	Integration of safety support tools for vehicle drivers.....	68
5.4	INTEGRATION OF SAFETY SUPPORT TOOLS FOR FLIGHT CREWS/VEHICLE DRIVERS AND FOR CONTROLLERS	69
5.4.1	General considerations	69
5.4.2	Safety support tools for flight crews on taxiway.....	69
5.4.3	Safety support tools for flight crews on runway.....	70
5.4.4	Traffic alerts for vehicle drivers.....	72
5.4.5	Area infringement alerts for vehicle drivers.....	73
6	OPERATIONAL EXAMPLES	74
6.1	RUNWAY INCURSIONS	74
6.1.1	Example 1.1: Aircraft cleared to take-off and aircraft crossing runway.....	74
6.1.2	Example 1.2: Variation on example 1.1 with RWSL.....	75
6.1.3	Example 2: Line-up without clearance with landing aircraft.....	76
6.2	INCIDENTS ON TAXIWAYS	78
6.2.1	Example 1: Vehicle passes too close in front of aircraft.....	78
6.2.2	Example 2: Closed area infringement.....	78
6.3	CONFLICTING ATC CLEARANCES	80
6.3.1	Example 1: Aircraft cleared to line-up while another aircraft is already cleared for landing 80	
6.3.2	Example 2: Aircraft cleared to take-off while vehicle is on the runway.....	81
6.3.3	Example 3: Aircraft cleared to land while vehicle is on the runway.....	81
6.4	NON-CONFORMANCE TO ATC CLEARANCES	83
6.4.1	Example 1: "Taxi without clearance".....	83
6.4.2	Example 2: Route deviation.....	83
6.4.3	Example 3: Non-conformance to taxiway suitability	85
7	REFERENCES.....	86
7.1	APPLICABLE DOCUMENTS.....	86
7.2	MAIN P06.07.01 DELIVERABLES	86
7.2.1	RWSL.....	86
7.2.2	Alerts for controllers.....	86
7.2.3	Conformance monitoring alerts for flight crews.....	86
7.2.4	Alerts for vehicle drivers.....	86
7.2.5	Traffic alerts for flight crews.....	87
7.3	OTHER DOCUMENTS.....	87

List of tables

Table 1 – Where do the safety support tools work?	30
Table 2 – Users and types of mobiles addressed by the tools	31
Table 3 – RELs logic	44

List of figures

Figure 1 – Reported runway incursions in Europe (2004-2008)	14
Figure 2 – Actors involved in a sample of runway incursions	15
Figure 3 – Reported runway incursions in Europe (EVAIR, 2008-2012)	15
Figure 4 – Different sets of lights part of the RWSL SolutionConflicting ATC Clearances detection (CATC)	25
Figure 5 – Indication (orange lines) of potential CATCs on an EFS (example only, other implementations of this concept exist)	33
Figure 6 – Indication of a potential CATC in a warning window (example only, other implementations of this concept exist)	34
Figure 7 – Conflicting ATC clearances detection – Functional architecture	36
Figure 8 – Conformance monitoring alerts – Example of Route Deviation Alert 'INFORMATION'	39
Figure 9 – Conformance monitoring alerts – Example of Route Deviation Alert 'ALARM'	39
Figure 10 – Conformance monitoring alerts – Ground functional architecture	40
Figure 11 – RWSL system	45
Figure 12 – Functional architecture for conformance monitoring alerts for flight crews	51
Figure 13 – Scheme of Relevant Traffic position assessment in relation to ownship.....	56
Figure 14 – Functional architecture for traffic alerts for flight crews	57
Figure 15 – Zones for traffic alerts for vehicle drivers.....	62
Figure 16 – Functional architecture for alerts directly generated on-board the vehicle.....	63
Figure 17 – Functional architecture for alerts uplinked to the vehicle	64

Executive summary

To further improve safety of airport operations, in particular with the perspective of a traffic increase assumed by SESAR, P06.07.01 and P09.14 develop and validate several safety support tools for flight crews, vehicle drivers and controllers:

- Runway Status Lights (RWSL) consists in a system of lights that automatically and directly indicate to vehicle drivers and flight crews when it is dangerous to enter, use or cross a runway.
- Detection of conflicting ATC clearances will be based on the ATC clearances input by the controller in a digital system such as Electronic Flight Strips (e.g. one aircraft is cleared to land while another aircraft is cleared to cross the same runway in front of the landing aircraft).
- Conformance monitoring alerts are generated to the controllers in case of non-conformance to ATC instructions, or non-conformance to ATC procedures and aircraft state.
- Conformance monitoring alerts are generated to the flight crew in case of non-compliance to ATC instructions, or non-conformance to ATC procedures and aircraft state. These alerts are independent from the level of airport equipment in terms of safety support tools.
- Traffic alerts will draw the attention of flight crews (as they mainly look out the window during the airport surface operations) in case of a risk of collision with an aircraft or a ground vehicle on a runway.
- Two types of alerts will assist vehicle drivers when a potential risk of collision is imminent:
 - Traffic alerts on the manoeuvring area towards aircraft; and
 - Alerting functions in case of infringement of a restricted or closed area.

When implemented, these safety support tools will add themselves to some existing ones:

- A-SMGCS Runway Incursion Monitoring systems (RIMS) generate alerts in case of conflicts / infringements on runway caused by aircraft or vehicles and incursions in restricted areas caused by aircraft.
- Visual aids at runway entries (i.e. stop bars, runway guard lights, and signs and markings) indicating to the flight crews and the vehicle drivers the proximity to a runway.

These safety support tools can be associated with some other tools:

- Surface traffic display to flight crews (ATSA-SURF) provides flight crews with a display of surrounding aircraft and ground vehicle position and other information together with the own-ship position overlaid on a map of the airport. Standards already exist for this tool (DO-322).
- Display of traffic on airport map to vehicle drivers supplements the normal out-the-window scan to enhance traffic situational awareness on the airport surface for both taxiway and runway operations. This tool is developed by P06.07.01.

All these tools are mostly designed independently of each other as they should be operable individually. Nevertheless, several of them can be simultaneously available to flight crews, vehicle drivers and controllers.

Furthermore, in a given situation, some alerts can be generated to flight crews and/or vehicle drivers and/or controllers (e.g. conformance monitoring alerts for flight crews and controllers, or A-SMGCS RIMS alerts for controllers and Traffic alerts for flight crews).

This document provides an overview of the safety support tools developed and validated by P06.07.01 and P09.14, providing a general description, a functional architecture and a list of identified benefits, technological enablers, constraints, limitations, assumptions, problems and risks. The service and environment are further described in OSEDs.

founding members



Avenue de Cortenbergh 100 | B -1000 Bruxelles
www.sesarju.eu

7 of 88

It highlights the possible interactions between all the safety support tools (including the existing ones) available to a single user (i.e. flight crew, vehicle driver and controller) and to different users.



1 Introduction

1.1 Purpose of the document

This document addresses all the safety support tools included in the P06.07.01 and P09.14 scope:

- Runway Status Lights (RWSL);
- Detection of conflicting ATC clearances;
- Conformance monitoring alerts for controllers;
- Conformance monitoring alerts for pilots;
- Alerts for vehicle drivers (both traffic alerts and alerts in case of infringement of restricted or closed areas); and
- Traffic alerts for pilots.

It has a double objective:

- To keep an overall and consistent view on each safety support tool defined and validated by P06.07.01 and P09.14 to improve airport safety; and
- To address the aspects related to the integration of all these safety support tools (including those already in operations), both inside each domain (i.e. cockpit, ATC and vehicle) and between domains.

The activities on these safety support tools conducted by P06.07.01 are coordinated with the relevant WP09 and WP12 projects developing prototypes including these functions. These projects are more interested in the OSED, SPR and INTEROP developed by P06.07.01 (as they provide lists of requirements) than in this document which is more general and operationally focused. Some prototypes developed by the industrial projects will integrate several of these safety support tools and must ensure interoperability between them.

This deliverable is the third version of the OCD. A first version (D03) and a second version (D04) were delivered during the course of P06.07.01 activities. This version (D05) provides an update based on the work conducted by P06.07.01 since the issue of the second version of the OCD (OSED development, trials, etc.). No other iteration is scheduled until the end of the project.

This version of the OCD includes the following changes:

- General update of the descriptions of the safety support tools in order to be consistent with the latest versions of the OSEDs and planned V3 validations. Particularly, it introduces the following main changes:
 - For Conflicting ATC Clearances detection (CATC), the possibility to provide predictive indications to the controller to show him that if the clearance is selected then it will be conflicting with another one. CATC implementation could thus be limited to predictive indications (i.e. CATC alert may not be triggered depending on local implementation). See section 5.1.2.
 - The detection of Conflicting ATC Clearances and the conformance monitoring alerts for controllers are now addressed in a single OSED, which also takes account of the existing A-SMGCS RCMA alerts. It implies that the coexistence of these three tools is part of this OSED, particularly through the definition of priority rules for the display of the various alerts to the controllers. See section 5.1.1.
 - The description of traffic alerts for pilots is aligned with the planned V3 validations in P09.14 and with the future update of OSED. Particularly, two types of implementation

are described for traffic alerts on runway. A description of traffic alerts on taxiways is also provided to fully reflect the planned V3 validations in P09.14. See section 5.2.3.

- The analysis of coexistence of the various safety support tools from the flight crew's viewpoint is updated accordingly. See section 5.2.4.
- A more detailed analysis of the coexistence of the various safety support tools, with a focus on the coexistence between traffic alerts for pilots on runway and other ground-based safety support tools for controllers. See sections 5.1.4.6 and 5.4 (and more specifically section 5.4.3.5). The potential issues described in these sections were presented and discussed in a Workshop on 20/01/2015 but none of these potential issues were validated or ruled out. They should be addressed during validations and some of them will require some integrated validations with both ground and airborne alerts.

1.2 Intended readership

Participants in the following related SESAR projects can be interested in this document:

- P06.02 (Coordination and consolidation of operational concept definition and validation) and P06.03.01 (The Airport in the ATM environment) to have in a single document an overview of all the airport safety support tools in P06.07.01 and P09.14 scope.
- P06.07.01 (all WAs) to ensure consistency with the documents developed within each work area.
- P09.14 to ensure consistency with the documents developed in this project, particularly as it took over the development of the safety support tools for pilots from P06.07.01 (OSD, SPR and INTEROP).
- P12.03.02 and P12.05.04 as the analysis on the integration of all these safety support tools may be of interest for the development of technical specifications and prototypes.

1.3 Inputs from other projects

This document is developed based on documents delivered by P06.07.01, mainly the OSD and the Validation Reports. The detailed list is provided in section 7.2.

1.4 Glossary of terms

Term	Definition
Alert	Indication of an existing or pending situation during aerodrome operations, or an indication of abnormal A-SMGCS operation, that requires attention /action. [ICAO-A-SMGCS Manual 9830]
Land And Hold Short Operation	Operations which include simultaneous take-offs and landings and/or simultaneous landings when a landing aircraft is able and is instructed by the controller to hold-short of the intersecting runway/taxiway or designated hold-short point. Pilots are expected to promptly inform the controller if the hold short clearance cannot be accepted. [4]
Manoeuvring area	That part of an aerodrome to be used for the take-off, landing and taxiing of aircraft, excluding aprons. [ICAO Annex 14]
Movement area	That part of an aerodrome to be used for the take-off, landing and taxiing of aircraft, consisting of the manoeuvring area and the apron(s). [ICAO

founding members



Avenue de Cortenbergh 100 | B -1000 Bruxelles

www.sesarju.eu

10 of 88

	Annex 14]
--	-----------

The following terminology is used to describe the alerts provided to controllers [17]:

Term	Definition
Information alert (stage 1)	Information level is used to inform the controller that a situation which is potentially dangerous may occur, and he/she needs to be made aware of. According to the situation, the controller receiving this level of alert may take a specific action to resolve the alert if needed.
Alarm alert (stage 2)	Alarm level is used to inform the controller that a critical situation is developing which needs immediate action.

The following terminology is used to describe the indications and alerts provided to flight crews [24]:

Term	Definition
Traffic Indication	Traffic Indication is provided if there is no immediate collision hazard with ownship but a collision hazard could develop over some time.
Runway Status Indication	Runway Status Indication is provided if the flight crew should verify runway status prior to proceeding.
Advisory alert (level 1)	Advisory level is used for conditions that require flight crew awareness and may require subsequent flight crew response.
Caution alert (level 2)	Caution level is used for conditions that require immediate flight crew awareness and subsequent flight crew response.
Warning alert (level 3)	Warning level is used for conditions that require immediate flight crew awareness and immediate flight crew response.

The following terminology is used to describe the alerts provided to vehicle drivers:

Term	Definition
Caution alert (level 1)	Caution level is generated to vehicles about a situation that is becoming potentially dangerous, providing information to help the vehicle driver understand the reason for the danger.
Warning alert (level 2)	Warning level is generated to vehicles about an imminent danger situation. The vehicle driver should take immediate action to avoid an accident and leave the zone according to local procedures for warning alert.

1.5 Acronyms

founding members



Avenue de Cortenbergh 100 | B -1000 Bruxelles
www.sesarju.eu

11 of 88

Acronym	Definition
A/C	Aircraft
A-SMGCS	Advanced Surface Movement Guidance & Control System
ADS-B	Automatic Dependent Surveillance – Broadcast
AGL	Airfield Ground Lighting
ATC	Air Traffic Control
ATM	Air Traffic Management
ATSA-SURF	Enhanced Traffic Situational Awareness on the airport surface
D-ATIS	Digital Automatic Terminal Information Service
D-NOTAM	Digital NOTAM
D-OTIS	Digital Operational Terminal Information Service
ECAC	European Civil Aviation Conference
EFS	Electronic Flight Strips
FLS	Field Lighting System
FMS	Flight Management System
GASR	Group of Aerodrome Safety Regulators
HMI	Human Machine Interface
ICAO	International Civil Aviation Organization
JAA	Joint Aviation Authorities
LAHSO	Land And Hold Short Operation
LVP	Low Visibility Procedure
MLAT	Multilateration
MOPS	Minimum Operational Performance Standards
NOTAM	Notice To Air Men
OANS	On-board Airport Navigation System
OSD	Operational Service and Environment Definition
P2P	Peer-To-Peer
PCN	Pavement Classification Number

Acronym	Definition
RELs	Runway Entrance Lights
RMCA	Runway Monitoring and Conflict Alerting
RSI	Runway Status Indication
RWSL	Runway Status Lights
RWY	Runway
SDF	Sensor Data Fusion
SMR	Surface Movement Radar
TCAS	Traffic alert and Collision Avoidance System
THLs	Take-off Hold Lights
TI	Traffic Indication
SESAR	Single European Sky ATM Research
TAWS	Terrain Awareness And Warning System
TIS-B	Traffic Information Surveillance – Broadcast
VDS	Vehicle Display System
VFR	Visual Flight Rules

2 Operational Context

2.1 Operational issues

2.1.1 Runway incursions

A runway incursion is defined by ICAO as: "**any occurrence at an aerodrome involving the incorrect presence of an aircraft, vehicle or person on the protected area of a surface designated for the landing and take-off of aircraft**". Runway incursions are the major concern for the safety on the airport surface. This issue concerns all mobiles on the airport, i.e. both aircraft and vehicles.

The runway incursions occur on airports with totally different characteristics (i.e. from large and complex airports with multiple runways to small aerodromes used by General Aviation Traffic operating in VFR). Airports with closely spaced parallel runways have an additional risk because arriving aircraft usually have to cross the take-off runway to taxi to the terminal. Another operational context leading to additional risk is airports with snow removal procedures.

In July 2001 a joint runway safety initiative was launched by GASR (Group of Aerodrome Safety Regulators), JAA, ICAO and EUROCONTROL to investigate specific runway safety issues and to identify preventative actions. The main result was the development of the "European Action Plan for the Prevention of Runway Incursions" that was distributed in April 2003 and approved by the EUROCONTROL Provisional Council in April 2004.

Although a number of actions have been taken in the past to reduce their number (e.g. better signage), and some safety nets have been introduced for controllers (A-SMGCS RIMS), runway incursions are still a safety issue.

According to the Safety Regulation Commission Annual Safety Report 2009, "*reported data for the 2008 reporting year shows an increase of about 3% in total numbers of Runway Incursions. At the same time, 2008 has seen an increase in the number of serious incidents (Severity A), with a small decrease in Severity B occurrences reported in comparison with 2007*".

The "Preventing Runway Incursions" Portal of the EUROCONTROL Runway Safety Project provides some figures on the number of runway incursions reported in Europe.

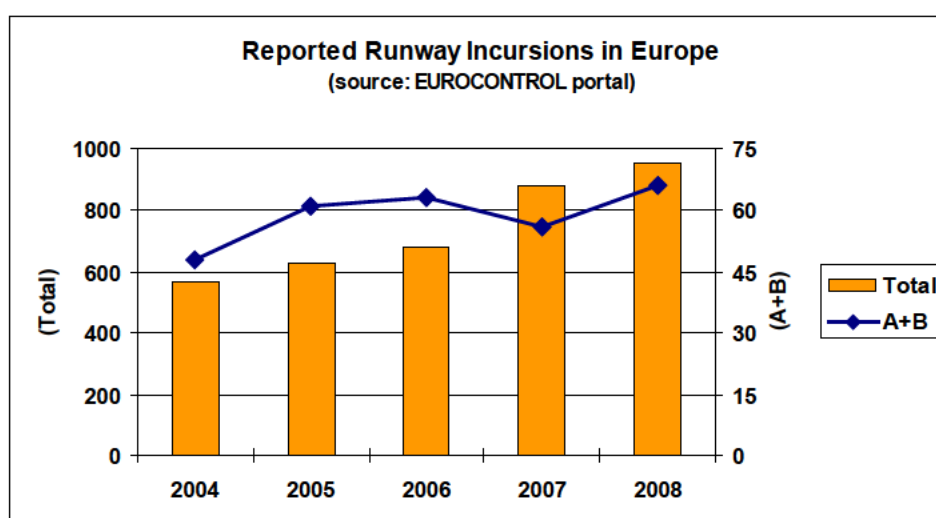

Figure 1 – Reported runway incursions in Europe (2004-2008)

founding members



Avenue de Cortenbergh 100 | B -1000 Bruxelles
www.sesarju.eu

14 of 88

Note: "Severity A" corresponds to serious incidents and "Severity B" to major incidents.

In 2008 the total number of arrival and departures in ECAC was 12,213,585. It means that a runway incursion was reported every 12,789 movements (i.e. $7.8E-05$) and a runway incursion with a severity A or B every 185,054 movements (i.e. $5.4E-06$). It should be noted that actual situation may be even worse as the figure is computed based on reported events only.

Note: It is also worth noticing that vehicles represent a significant part of runway incursions. The EUROCONTROL portal also provides based on limited sample the percentage of people in different professional group having been involved in a runway incursion.

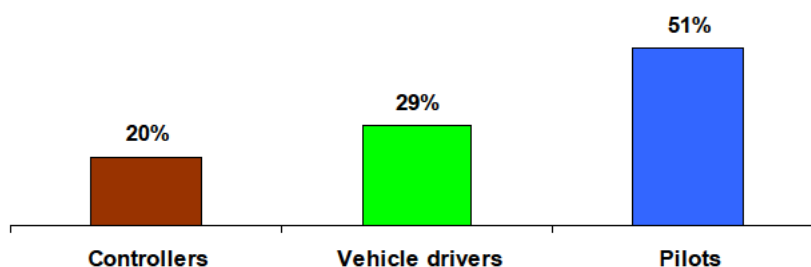

Figure 2 – Actors involved in a sample of runway incursions

This trend observed between 2004 and 2008 is confirmed by the EVAIR Safety Bulletin N°11 for the period 2008-2012 [25]. This report cross-checked the robustness and quality of EVAIR data with the IATA STEADES data base to conclude that the overall trend line of runway incursions is increasing over the period 2008-2012, as depicted in the figure below.

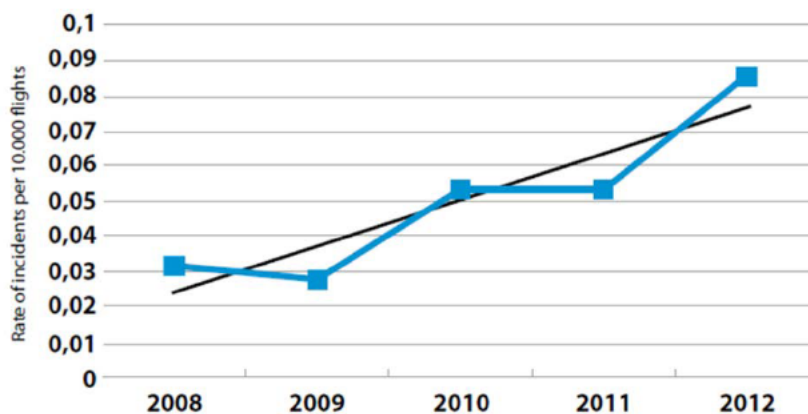

Figure 3 – Reported runway incursions in Europe (EVAIR, 2008-2012)

In this context, the SESAR CONOPS Step 1 [7], section 3.5.2 (Airport Safety), highlights the need to increase surface movement capacity without increasing the risk of runway incursions and taxiing and apron incidents and/or accidents.

2.1.2 Incidents on taxiways

The potential consequences of incidents on taxiways are less safety critical than on runways as the speeds of the mobiles (in particular the aircraft) are lower. Therefore, the efforts to enhance airport

surface safety are mainly focused upon protecting the runway environment. Besides, incidents on taxiways can have other consequences than safety, e.g. delayed taxi, disturbance of traffic flow.

The taxiway system of an airport is a complex environment – its layout is highly dependent on the local operational environment and with a high number of movements on the taxiways accidents between two aircraft or between aircraft and vehicle do occur. The severity of such accidents may typically be less than that of accidents due to runway incursions, but the damage to property and operational efficiency can lead to high costs for airlines. As the efforts to enhance airport surface safety are mainly focused upon protecting the runway environment, there is no active monitoring activity of incidents on taxiways and therefore it is not easy to quantify their number although they occur.

It is relatively easy for flight crews and vehicle drivers to become disorientated on the surface of an airport, particularly if they are not familiar with the local procedures or taxiway layout. The lack of features on an airport surface often serves to compound the problem, particularly in low visibility conditions.

Use of safety nets on taxiway systems is for the moment not very common. In addition to the lower safety criticality than runway incidents, the close proximity of traffic on the airport surface means that it can be very difficult to predict the immediate short term intent of mobiles. This is particularly the case with surface vehicles, which have a much higher agility than taxiing aircraft (which, for example, may require a tow truck to reverse). As therefore, it is not easy for an automated system to determine when a collision between mobiles on the taxiway is imminent without bombarding the operators with multiple false alerts. The difficulty centres on what set of alerting criteria should be used to set the thresholds for triggering a short term conflict alert.

2.1.3 Infringement of restricted or closed areas

This issue refers to two types of situations.

- Mobiles, whilst complying with the ATC clearances, are routed through (either temporarily or permanently) restricted or closed areas (which can be taxiways, runways or aprons).
- Mobiles penetrate restricted or closed areas without authorisation from ATC. It should be noted that in these situations mobiles are failing to comply with airport signage or published procedures and this is likely to be as much of a cause of infringement as not following ATC instruction.

Therefore potentially hazardous situations in this category can be assigned both to controller or mobile error. However, in general “potentially hazardous situations” in this category are likely to be caused by a controller error – i.e. aircraft complying with ATC clearances that guide aircraft to an inaccessible area or blocked route.

2.1.4 Detection of conflicting ATC clearances

This type of situation is generated when ATC provides mobiles with ATC clearances that, if followed, would bring them into conflict with other mobiles. This category includes situations when conflicting ATC clearances could result in a runway incursion, e.g. an aircraft is cleared for take-off and another mobile is given a crossing clearance in front of the aircraft on the same runway.

These situations can negatively impact safety (risk of collision).

2.1.5 Non-conformance to ATC instructions or procedures

This situation is caused when a mobile deviates from its assigned 3D-trajectory (the two dimensions on airport surface and the associated time dimension); i.e. does not adhere to the apron/taxiway/runway routing assigned to it. This category includes situations such as:

founding members



Avenue de Cortenbergh 100 | B -1000 Bruxelles
www.sesarju.eu

- Non-compliance to the ATC clearances by the flight crews and vehicle drivers in the proximity of active runways, e.g. aircraft/vehicle do not stop at the runway holding point;
- Where a communication misunderstanding occurs between what is meant by the instructions of the controller and what is interpreted by the mobile operator (e.g. as a result of communication break-down, through say callsign/conditional ATC clearances confusion, incorrect/missed read-backs, poor phraseology, lack of radio communications).

This category also covers deviations from standards operating procedures and practices by mobiles, such as aircraft taxiing with extreme taxi speed that can indicate for example intention to take-off from the taxiway.

In general, the causal factors that create this category of “potentially hazardous situation” are largely expected to be due to mobile operator error.

Non-conformance to ATC clearances by the flight crews and vehicle drivers (whatever the cause is, e.g. technical, operational) can be identified amongst the precursors of runway incursions.

2.2 Existing airport safety support tools

2.2.1 A-SMGCS Level 2

Note: A-SMGCS Level 2 is included in the OI Step AO-0102.

A-SMGCS Level 2 aims at complementing surveillance service with a control service which provides a runway safety net and prevents incursions into restricted areas. EUROCONTROL has elaborated the operational concept and requirements ([17]) that is taken as input for the Community Specification EN 303 213-2 ([18]).

Following is an excerpt of EUROCONTROL’s operational concept description ([17], §2.2):

“At Level 2, A-SMGCS consists in the introduction of automated surveillance (identical to Level 1) complemented by an automated service capable of detecting conflicts and infringements of some ATC rules involving aircraft or vehicles on runways and restricted areas. Whereas the detection of conflicts identifies a possibility of a collision between aircraft and/or vehicles, the detection of infringements focuses on dangerous situations because one or more mobiles infringed ATC rules. A-SMGCS Level 2 does not address conflicts between two vehicles, but only between an aircraft and another mobile.

The A-SMGCS control service is available for all weather conditions, traffic density and aerodrome layout. In particular, an A-SMGCS Level 2 is able to assist the controller in preventing collisions between aircraft and mobiles especially under reduced visibility conditions.

The conflicts / infringements considered at Level 2 are related to the most hazardous ground circulation incidents or accidents. They could be defined as follows:

- *conflicts / infringements on runway caused by aircraft or vehicles; and*
- *restricted areas incursions caused by aircraft (i.e. incursions on a closed taxiway or runway).*

Further extension of conflict detection to cover taxiway intersections has not been retained for Level 2, because it seems technically difficult, at Level 2, to correctly detect these conflicts without providing inappropriate alerts.

When an alert situation is detected the A-SMGCS control service generates an appropriate alert to controllers. At Level 2, alerts are provided only to controllers.”

A-SMGCS Level 2 systems are not widely implemented but such systems are in operations in some main European airports like Paris Charles de Gaulle, London Heathrow, Zurich or Prague.

founding members



Avenue de Cortenbergh 100 | B -1000 Bruxelles
www.sesarju.eu

17 of 88

2.2.2 Visual aids at runway entries

Several visual aids are implemented and described accordingly in ICAO documents (e.g. ICAO Annex 14 [21] and respective Aerodrome Design Manual) as well as in the Commission Regulation on aerodromes (cf. [26] [27]) to indicate to the flight crew and the vehicle driver the proximity to a runway. They also play an important role to prevent runway incursions as indicated in the “European Action Plan for the Prevention of Runway Incursions” (EAPPRI, [19]).

Visual aids at runway entries are:

- Stop bars
- Runway guard lights
- Signs and markings

Note: Other visual aids can be available on the airfield:

- Taxiway Centreline Lights
- Intermediate Holding Position Lights

2.2.2.1 Stop bars

The stop bars consist in lights that supplement markings in order to protect runways in all weather conditions. They must be controlled either manually or automatically by air traffic services. As specified in ICAO Annex 14 and in the Commission Regulation on aerodromes, stop bars shall be provided at every runway-holding position serving a runway when it is intended that the runway will be used in runway visual range conditions less than a value of 550 m except if some specific measures exist. Furthermore, it is noted that the provision of stop bars at runway holding positions and their use at night and in visibility conditions greater than 550 m runway visual range can form part of effective runway incursion prevention measures.

The use of stop bars is described by ICAO:

- Annex 2 [23] states “*An aircraft taxiing on the manoeuvring area shall stop and hold at all lighted stop bars and may proceed further when the lights are switched off*”. This standard applies to both runways and taxiways where fitted with stop bars. The objective of this standard is to maintain the integrity of the stop bars, which are intended to protect the relevant part of a manoeuvring area.
- PANS-ATM (Doc 4444) [22] states “*7.14.7 Stop bars shall be switched on to indicate that all traffic shall stop and switched off to indicate that traffic may proceed*.” As such, a controller should never issue a clearance to cross a stop bar without first switching off the stop bar. The only exception to this should be when contingency measures are required due to serviceability. An example of a contingency measure is the use of a follow-me vehicle.

Stop bars are implemented in a large number of international airports.

2.2.2.2 Runway guard lights

The runway guard lights are flashing lights at runway entries to warn flight crews and vehicle drivers of the fact that they are entering an active runway. As specified in ICAO Annex 14 and in the Commission Regulation on aerodromes, runway guard lights shall be provided at runway entries serving a runway that is intended to be used in visibility conditions less than 550 m, unless stop bars are provided. They shall also be provided for visibility conditions between 550 m and 1200 m for runways with high traffic intensity. Lastly, they are recommended to be used for all other conditions also in combination with a stop bar.

founding members



Avenue de Cortenbergh 100 | B -1000 Bruxelles
www.sesarju.eu

Runway guards should be “on” permanently when a runway is active.

2.2.2.3 Signs and markings

Signs and markings warn flight crews and vehicle drivers that they are about to enter a runway. ICAO Annex 14 and the Commission Regulation on aerodromes specify the location and type of signs and markings depending on the airport category (length of runway, types of aircraft) and the ILS-category (if any).

2.2.3 Surface traffic display to flight crews (ATSA-SURF)

Note: ATSA-SURF is included in the OI Step AUO-0401.

Taking benefits of new airborne surveillance capabilities with the emergence of the ADS-B (Automatic Dependent Surveillance – Broadcast) and TIS-B (Traffic Information Surveillance – Broadcast) technologies, some new applications are being implemented.

One of them (ATSA-SURF: “Enhanced Traffic Situational Awareness on the airport surface”) aims at providing flight crews with a display of surrounding mobile (i.e. aircraft and ground vehicles) position and other information together with the own-ship position overlaid on a map of the airport. The information provided by the traffic display is intended to supplement the normal out-the-window scan to enhance traffic situational awareness on the airport surface for both taxiway and runway operations. The supplemental information provided by this application may be used by flight crews whenever airport surface operations are conducted.

The primary goal of this traffic display and associated procedures is to reduce the potential for errors, runway and taxiway incursions, and collisions by providing enhanced traffic situational awareness to the flight crew operating an aircraft on the aerodrome surface, and including final approach, landing and take-off operations in the vicinity of the aerodrome surface.

The ATSA-SURF application does not change the responsibilities of either flight crews or controllers. The flight crew continues to be responsible for the operation of the aircraft and for complying with the provided clearance. The controller continues to be responsible for assuring safe airport surface operations through appropriate issuance of ATC clearances throughout the ATSA-SURF application.

The ATSA-SURF standards have been approved by EUROCAE and RTCA (ED-165/DO-322 “Safety, Performance and Interoperability requirements document for enhanced Traffic Situational Awareness on the airport surface (ATSA-SURF)” released in December 2010) and associated MOPS (Minimum Operational Performance Standards) have also been produced (ED-194/DO-317A).

An airborne system definition has been made for coming implementation in relation with the related SPR.

2.2.4 Alerting and surface traffic display for vehicle drivers

Although there have been studies and prototype developments at several airports to display traffic on an airport moving map and/or to alert vehicle drivers in case of a runway incursion (e.g. at Bordeaux, Frankfurt, Zurich), only Paris CDG has been using such a system for several years and deployed it operationally. The current system displays on a separate screen the vehicle own position as well as other traffic stemming from the A-SMGCS. In case of a runway incursion (defined as crossing the CATIII area, i.e. 150m from the runway centreline), an alarm is generated and displayed in red.

3 General benefits, problems and assumptions

3.1 Operational benefits

3.1.1 General perspective

With the planned increase of traffic in the upcoming years, the main airports will be even busier than today and some airports with a current low traffic will see the number of movements significantly increasing. The development of new safety support tools will allow maintaining and even enhancing the current level of safety for the airport operations.

These benefits will be achieved by both better preventing hazardous situations to occur and better detecting these situations when they occur to be able to take appropriate actions for the prevention of severe consequences.

A key factor will be an involvement of all actors, i.e. controllers, flight crews and vehicle drivers. In some situations, it will provide several successive barriers before a severe incident or accident occur. It will also maximise the number of situations in which at least one safety support tool will be available (e.g. non-equipped airports but equipped aircraft).

3.1.2 Controller perspective

Compared to A-SMGCS RIMS, the main operational advantage sought by controllers with new airport safety support tools is increased time available to identify what actions need to be taken and instruct the concerned flight crew or vehicle driver. The success of any intervention is improved where the controller is made aware of the risk earlier.

3.1.3 Flight crew perspective

The primary source of information of flight crews during surface movements is visual observation. However, automated support should offer benefits, particularly on complex airport layouts, in degraded visibility conditions (night, rain, low visibility) or in case of high flight crew workload.

The support from automation in the detection of hazardous situations (e.g. risk of collision on the runway) is expected to increase the traffic situational awareness of flight crews who will be able to apply appropriate actions to prevent dramatic consequences. The traffic alerts for flight crews would be complementary to those triggered to the controllers and they should allow reducing the delay between the triggering and the corrective action as they do not require communications from the controller to the flight crews.

The SESAR programme is going to provide new cockpit functions to support the flight crews to navigate on the airport surface. These functions provide the opportunity for automatic triggering of alerts in case of navigation error.

In addition to the alerts leading to corrective actions, the provision of information to prevent hazardous situations to occur, in particular runway incursions, would greatly contribute to further increase safety of runway operations.

3.1.4 Vehicle driver perspective

The vehicle drivers are key actors for the airport safety, in particular when they operate on the manoeuvring area. Based on visual information, vehicle drivers navigate and detect any risk of collision with an aircraft or another vehicle. Electronic equipment displaying an airport moving map and

founding members



Avenue de Cortenbergh 100 | B -1000 Bruxelles
www.sesarju.eu

20 of 88

surrounding traffic are very useful for vehicle drivers especially when dealing with runway incursion situations and during low visibility (LVP).

As vehicle drivers normally drive their car and look out of the window, they do not regularly look at the moving map and displayed traffic. The triggering of alerts for closed or restricted areas as well as traffic alerts given for instance by an aural alert or/and flashing lights will draw their attention to the display, allowing the detection of the hazard.

3.2 Levels of alerts

3.2.1 Flight crews

For on-board systems, referring to CS 25-1322 [24], there are 3 possible levels of alert (matching with 3 criticality levels):

- **Level 1 or Advisory:** For conditions that require flight crew awareness and may require subsequent flight crew response.
- **Level 2 or Caution:** For conditions that require immediate flight crew awareness and subsequent flight crew response.
- **Level 3 or Warning:** For conditions that require immediate flight crew awareness and immediate flight crew response.

Some characteristics are:

- Warning is associated with “red” colour and an audio signal,
- Caution is associated with “amber” or “yellow” and an audio signal,
- There is no audio associated with advisories.

This rule is applicable to any kind of event e.g. system failure, risk of collision with terrain.

It is reminded that, whatever the context, the flight crew can be supported by information displayed on-request like an airport moving map, traffic, etc...

In this document, Conformance monitoring and Traffic Alerts for flight crews are concerned by this definition.

As a complement about Traffic alerts for flight crews, a notion of indication has been used in RTCA DO-323 for SURF IA which is an intermediate level below alerts and above traffic display:

- **Indications:** to indicate a normal operational condition that could become a runway, traffic safety hazard. Indications do not actively attract attention from flight crews but provide enhanced situation relevant information to facilitate flight crew perception of potential safety hazards. Indications are not alerts.

3.2.2 Controllers

Different levels of severity for alert situations may be distinguished. For each alert, a different alert stage is defined. Two stages of alerts are recommended. This recommendation is also based on the experience and practices of current A-SMGCS systems in Europe.

These 2 stages of alert are defined as follows:

- Stage 1 alert is used to inform the controller that a situation which is potentially dangerous may occur, and he/she needs to be made aware of. According to the situation, the controller

receiving a stage 1 alert may take a specific action to resolve the alert if needed. This is called INFORMATION step.

- Stage 2 alert is used to inform the controller that a critical situation is developing which needs immediate action. This is called ALARM step. [17]

3.2.3 Vehicle Drivers

Different levels of severity for alert situations may be distinguished. For each alert, a different alert stage is defined. Two stages of alerts are recommended and have been judged useful in previous validations [13].

These 2 stages of alert are defined as follows:

- Caution alert (stage 1) is generated to vehicles about a situation that is becoming potentially dangerous, providing information to help the vehicle driver understand the reason for the danger.
- Warning alert (stage 2) is generated to vehicles about an imminent danger situation. The vehicle driver should take immediate action to avoid an accident and leave the zone according to local procedures for warning alert.

3.3 Problems and risks

The airport safety support tools developed and validated by P06.07.01 and P09.14 aim at increasing the current level of safety for airport operations. This is done in considering each of them separately. For instance, RWSL can be implemented on an airport in which conflicting ATC clearance alerts and conformance monitoring alerts will not be available.

When several of these tools are available at the same time, the objective is at least to keep on increasing safety. To achieve it, two particular aspects should be carefully investigated:

- The integration of the various safety support tools provided to the controllers, flight crews and vehicle drivers (e.g. conflicting ATC clearance alerts, A-SMGCS RIMS alerts and conformance monitoring alerts provided to controllers); and
- The interoperability between similar types of alerts triggered to the different users (e.g. A-SMGCS RIMS alerts for controllers and traffic alerts for flight crews).

The benefits provided by each safety support tool will be dependent on the percentage of aircraft and vehicles which are suitably equipped to support them. For instance, the safety support tools based on surveillance data transmitted by aircraft and vehicles through ADS-B will not provide their full benefits before all these mobiles are appropriately equipped. During mixed mode operations, it must be ensured that the safety is not adversely affected.

The number of false alerts should be as low as possible, but the acceptable rate has to be defined for each of them as they may vary between the various tools.

The performance of the airport surface surveillance could be an issue as the performance provided for existing A-SMGCS implementations may not be sufficient, as highlighted during RWSL validation activities. The overall rate of false alerts will need to be maintained although the number of alerts is increased: this could also require increasing the performance of the airport surface surveillance.

3.4 Assumptions

The following assumptions apply to the new safety support tools:

- The safety support tools do not require any change in the current roles and responsibilities of controllers, flight crews and vehicle drivers.

founding members



Avenue de Cortenbergh 100 | B -1000 Bruxelles
www.sesarju.eu

- The safety support tools are designed independently of each other as they should be operable individually.
- The safety support tools provide their role under all visibility conditions.
- Some equipment (e.g. traffic display for flight crews or vehicle drivers, electronic stripping for controllers) may be required for the deployment of safety support tools. This equipment is identified in the description of safety support tools (section 5).
- The working methods are adapted to minimise the number of false alerts (e.g. clearances are input into the system by controllers when they are given by R/T).
- The safety support tools do not interfere in a conflicting way but work in a coherent way.
- All aircraft and vehicles are equipped with transponders that are switched on whilst on the movement area.

4 New airport safety support tools

4.1 Overview

This section provides a general overview of the considered safety support tools. A detailed description of each of them (including environment, procedures, use cases etc.) is provided in the associated OSED developed by P06.07.01.

4.1.1 Runway Status Lights (RWSL)

Note: RWSL is included in the OI Step AO-0209.

Runway Status Lights (RWSL) is an independent surveillance driven system. It is designed to reduce the number and severity of runway incursions and prevent runway accidents while not interfering with airport operations.

The information on runway usage is directly made available to the vehicle drivers and flight crews through new airfield lights, which can be composed of:

- Runway Entrance Lights (RELs): sets of red lights illuminating runway entrances when it is not safe to enter or cross the runway;
- Take-off Hold Lights (THLs): sets of red lights illuminating along the axis of a runway in front of a departing aircraft when it is unsafe to take-off from that runway due to a vehicle or aircraft already occupying the runway ahead;
- Runway Intersection Lights (RILs): sets of red lights illuminating along the axis of a runway near the intersection with another runway (crossing runways only) when it is not safe to go through the intersection. The concept for RILs is not as mature as RELs/THLs, and they will not be validated during the planned V3 validations as there are no crossing runways at the target validation site, and therefore not further detailed in this document.

It is important to note that RELs, RILs and THLs only indicate the status of the runway, and *do not indicate a clearance*.

The FAA has performed significant work on the subject at several U.S. airports since 2004. Given the promising results observed in the U.S., RWSL has been included in the scope of P06.07.01, with the objective to remain as close as possible to the U.S. definition for harmonization and consistency purposes (e.g. target U.S./Europe common operational procedures for Flight Crews).

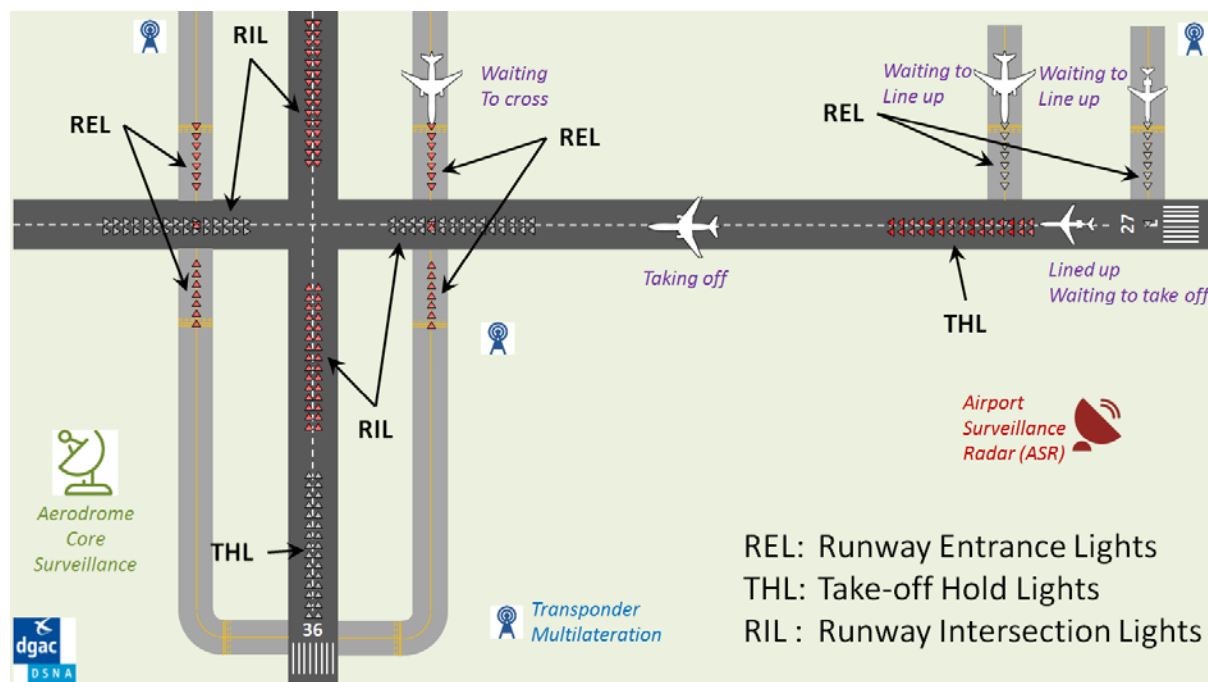

Figure 4 – Different sets of lights part of the RWSL Solution Conflicting ATC Clearances detection (CATC)

Note: Conflicting ATC clearances detection is included in the OI Step AO-0104-A.

Many ATC towers are now equipped with A-SMGCS and Electronic Flight Strips (EFS) allowing the controllers to see the position of mobiles and input ATC clearances on the EFS. However, there is often no, or limited integration of the two tools and the Control function of A-SMGCS will only raise alerts when mobiles are detected in conflict on, or approaching a runway, and these alerts are only triggered based on surveillance and not linked to the controller intentions.

Studies have shown that combining EFS data with A-SMGCS surveillance data can bring safety benefits for controllers and mobiles operating on the manoeuvring area.

A review of recent runway incursions and incidents at airports showed that many were caused because a controller forgot that he/she had already allocated a runway to one mobile and then gave a clearance to another mobile to use the same runway, an example being; clearing one aircraft to land and then giving another aircraft clearance to line up or cross the same runway.

In order that false alerts are kept to a minimum the concept relies on the procedure that controllers make timely inputs to the EFS and where applicable the A-SMGCS compares the position of the mobiles when the inputs are made. The identification and alerting of ATC conflicting clearances will not replace the Control function of A-SMGCS, moreover it will prevent avoiding action by the controller by predicting dangerous situations before they get to a situation where the mobiles are close to collision.

4.1.2 Conformance Monitoring Alerts for Controllers (CMAC)

Note: Conformance monitoring alerts for controllers are included in the OI Step AO-0104-A.

The introduction of Electronic Flight Strips (EFS) means that the instructions given by the ATCO are now available electronically and can be integrated with other data such as flight plan, surveillance, routing, published rules and procedures. The integration of this data allows the system to monitor the information and when inconsistencies are detected, the ATCO can be alerted via the HMI or audibly

founding members



Avenue de Cortenbergh 100 | B -1000 Bruxelles
 www.sesarju.eu

25 of 88

with a buzzer. The main benefit of this is the **early detection** of flight crew / vehicle driver errors that, if not detected and resolved, might result in a hazardous situation. **The current A-SMGCS RIMS will still exist as the last minute warning system based on the position of the mobiles.**

When a hazardous situation is detected, the A-SMGCS will provide the controller with two types of alerts, named 'INFORMATION' and 'ALARM'

- **INFORMATION:** When receiving an 'information alert', this means that a potential hazardous situation may occur. The tower controller will use his skill and backgrounds to decide if, with remaining possible actions, the situation can be saved without using a too restrictive procedure (e.g. go around). If successful, there will be no alarm; if not successful the alarm will be activated and be presented on the surveillance display.
- **ALARM:** When receiving an "alarm", it is said that a critical situation is developing and that an immediate action should be performed. An alarm will also trigger an audio warning (.e.g. buzzer) in case the controller is not looking at the HMI at the time.

The alerts can be displayed on the EFS, the radar/track label and in a dedicated Alert Window on the screen. **It is recommended that all alerts that are triggered are shown in the Alert Window until they are resolved.** In the case where more than one alert is triggered for the same mobile it is recommended to display the alert with the highest priority only in the radar/track label and /or EFS, bearing in mind that all the alerts are being displayed in the Alert Window. Previous studies have highlighted the following issues:

- Display of alerts will be subject to local agreements as there has been a divided opinion on when to show an **ALARM** to ATCOs, when an **INFORMATION** alert would suffice, in other words restrict the number of **ALARM** to a minimum so that when they are triggered ATCOs react with the urgency they warrant. Also, should a Runway Incursion alert always be an **ALARM** regardless of whether other traffic is present or not?
- The number of false or nuisance alerts must be kept to a minimum so that ATCOs do not become complacent and ignore them. An example could be at an airport with high intensity runway operations where arrivals are closely spaced and regularly receive a late landing clearance; there might not be a need to implement the No Landing Clearance alert.
- The question of where (which controller position) and when to display alerts also brings divided opinion, however, initial requirements have been defined as guidance to implementation and it will be left to individual sites to define their own rules for this.
- It is not always possible to resolve the alert situation straight away, therefore, in the case of an **ALARM** ATCOs have requested the possibility to silence the warning buzzer once it has been activated so as not to continue to distract them or their colleagues. Similarly for an **INFORMATION** alert ATCOs requested the possibility to remove the alert from the EFS and the radar/track label but leave the alert showing in the alert window until it was resolved. This action helps to reduce clutter and distraction on the HMI.

4.1.3 Conformance Monitoring Alerts for Pilots (CMAP)

Note: Conformance monitoring alerts for pilots are included in the OI Step AUO-0605-B.

The "Conformance monitoring" safety support tool for pilots is addressing two different types of non-conformance:

- Non-conformance to ATC instructions, e.g. an aircraft is deviating from its cleared route;
- Non-conformance to ATC procedures and aircraft state, e.g. an aircraft is cleared to take-off on a runway that is too short with regard to the aircraft type.

The “Conformance Monitoring” safety support tool for pilots encompasses the following items:

- Compatibility between Taxiways/ Runway and aircraft type
- Conformance to Taxiways/ Runway status
- Deviation from the Taxi route
- Take-off from a taxiway

Conformance monitoring tool for the on-board side is presented in section 5.2.2.

Both ground and on-board alerts are independent, i.e. there is no automatic communication of an alert triggered on one side to the other side. Ground applications cover a wider field of conformance monitoring than on-board ones. However, the overall objective is the same one: to alert the controller or the flight crew that the aircraft is not conforming to the ATC instructions or procedures.

The interest of independence is to maximize the coverage of operational contexts:

- Airports equipped with CMAC can cope with all types of aircraft whether they have their own CMAP function or not;
- Airports equipped with data link communication but not with CMAC and aircraft with their own CMAP function and data link.

Note: Data linked information means:

- *D-Taxi clearance relating to deviation from the taxi route*
- *D-OTIS information relating to Taxiway/Runway status*

Some functions like take-off on taxiway and compatibility between taxiways/ runway and aircraft type can rely only on on-board information (current aircraft situation, information stored in an on-board database).

4.1.4 Display of traffic on airport map to vehicle drivers

Note: Display of traffic on airport map to vehicle drivers is included in the OI Step AO-0204.

The airport maps should be constructed according to the information model and information services developed in WP8. These models and services are based on the standards described in EUROCAE DO-99B, User Requirements for Aerodrome Mapping.

The traffic situation awareness for the vehicle drivers is enhanced by providing the vehicle drivers with a display of surrounding mobiles (i.e. aircraft and ground vehicles) position and other information together with the own-ship position overlaid on a map of the airport. The information provided by the traffic display is intended to supplement the normal out-the-window scan to enhance traffic situational awareness on the airport surface for both taxiway and runway operations. The supplemental information provided by this application may be used by the vehicle driver whenever airport surface operations are conducted.

The primary goal of a traffic display and associated procedures is to reduce the potential for errors and collisions between vehicles and aircraft on the manoeuvring area. It does not take away the responsibility neither from vehicle drivers to comply with given ATC clearances nor from the controller to issue safe ATC clearances and to follow up the traffic situation.

4.1.5 Alerts for vehicle drivers

Note: Alerts for vehicle drivers are included in the OI Step AO-0105.

founding members



Avenue de Cortenbergh 100 | B -1000 Bruxelles
www.sesarju.eu

In all weather conditions, but especially in adverse weather conditions, vehicle drivers have difficulties in finding their way and to know their exact position on the manoeuvring area. To assist them when a potential risk of collision or an infringement of a protected area is imminent, an alert will be triggered.

Alerts will be triggered on two different situations.

- Traffic alerts on the manoeuvring area towards aircraft;
- Alerting functions in case of infringement of a restricted or closed area.

A moving map will show own vehicle position and also the surrounding and conflicting traffic. The moving map is considered to be a pre-requisite.

4.1.5.1 Traffic alerts

Traffic alerts will be triggered when an aircraft and a vehicle are detected in conflict with each other.

There will be two levels of alerts.

- **Caution** up to a certain distance/time from conflict
- **Warning** when within this limit

A description of the traffic alerts is found in 5.3.2.

4.1.5.2 Infringement of restricted or closed areas

If a vehicle enters a restricted/closed area within the manoeuvring area without a clearance, an alert will be triggered and the driver will take appropriate actions. A restricted/closed area could be e.g. part of taxiway being closed due to maintenance.

There will be two levels of alert towards Closed/restricted areas:

- **Caution** when in a buffer zone around the runway
- **Warning** when entering the other areas.

A description of these alerts is found in 5.3.3.

4.1.6 Traffic alerts for flight crews

Note: The actual name of the P06.07.01 activities refers to "Traffic alerts for pilots". However, this document refers to "Traffic alerts for flight crews" as flight crew is the term used in accordance with B04.02 material.

Note: Traffic alerts for flight crews are included in the OI Step AUO-0605-A.

Traffic situational awareness is a key element to safety. To supplement out the window scan and listening to radio communications during airport surface operations, aircraft can be equipped with a display of detected surrounding mobiles on an airport map (ATSA-SURF). This system contributes to enhance the traffic situational awareness of the flight crews.

However, during the airport surface operations, both on taxiways and runways, flight crews are mainly looking out the window. Then, they may fail to notice a risk of collision with a mobile (i.e. aircraft or ground vehicle) is developing because:

- they did not look at the traffic display (attention focussed outside or range not adapted), and
- they did not detect it by out the window scan (low visibility, traffic behind the aircraft, ...).

founding members



Avenue de Cortenbergh 100 | B -1000 Bruxelles
www.sesarju.eu

28 of 88

So, in such situations triggering an alert would draw the attention of the flight crews about a possible risk of collision with another aircraft. Then, the effects of an alert are, depending on the alert type:

- attention getter to reduce the reaction time,
- support situation understanding to focus on the potential hazard (anticipation if time is left),
- If there is no more time to analyse the situation, the alert is set at “warning” level, meaning for the crew to have an immediate reaction for avoiding a collision. The reaction can be a go-around, stop or rejected take-off depending on the context.

The main operational need is to address runway operations (e.g. short final, landing, take-off, runway crossing).

4.2 Summary

Table 1 shows where the safety support tools investigated by P06.07.01 and P09.14 and part of the baseline will work and generate alerts if any, with distinction between Manoeuvring Area and Apron.

		Manoeuvring Area (1)		Apron	
		Runway operations	Taxiway operations	Taxiway	Parking
RWSL		Y	N	N	N
CATC		Y	N	N	N
CMAC		Y	Y	Y	Y
CMAP		Y	Y	Y	N
Alerts for vehicle drivers	Traffic	Y	Y	N	N
	Infringement	Y	Y	N	N
Traffic alerts for flight crews		Y	Y	N	N
A-SMGCS RIMS		Y	Y (2)	Y (2)	N
Visual aids at RWY entries		Y	N	N	N
ATSA-SURF		Y	Y	Y	Y
Traffic display for vehicle drivers		Y	Y	Y	Y

Table 1 – Where do the safety support tools work?

(1) On the ATC side

- “Runway operations” = Tower Runway Controller
- “Taxiway operations” = Tower Ground Controller

(2): The A-SMGCS RIMS part that is meant for taxiways is the area infringement functionality (risk of collision is indeed only for the runway).

Table 2 shows the users of the safety support tools (both those validated by P06.07.01 and P09.14 and the existing ones) and the types of mobiles addressed by the tools.

		Users	Types of mobiles addressed by the tools
RWSL		Flight crew Vehicle driver Controller (1)	-
CATC		Controller	Aircraft/aircraft Aircraft/vehicle
CMAC		Controller	Aircraft Vehicles
CMAP		Flight crew	(ownership)
Alerts for vehicle drivers	Traffic	Vehicle driver	Aircraft
	Infringement	Vehicle driver	(ownership)
Traffic alerts for flight crews		Flight crew	Aircraft Vehicles
A-SMGCS RIMS		Controller	Aircraft/aircraft Aircraft/vehicle
Visual aids at RWY entries		Flight crew Vehicle driver	-
ATSA-SURF (2)		Flight crew	Aircraft Vehicles
Traffic display for vehicle drivers		Vehicle driver	Aircraft Vehicles

Table 2 – Users and types of mobiles addressed by the tools

(1): The RWSL system is a support tool for flight crews and vehicle drivers. However, the status of the lights (i.e. on/off) could be displayed on the controller A-SMGCS display.

(2): ATSA-SURF is not yet implemented on large commercial aircraft.

5 Description of operational concepts

5.1 Tools for tower controllers

5.1.1 Prioritisation of Alerts

The new CATC and CMAC alerts described in P06.07.01 OSED D32 [9] are not meant to replace the Runway Incursion Monitoring System (RIMS) implemented in A-SMGCS Level 2 but to complement RIMS by predicting incidents before the RIMS Alerts trigger. Therefore, the RIMS Alerts have a higher priority than other alerts.

In certain situations it will be possible for more than one alert to be triggered for the same mobile e.g. an aircraft LINING UP with no clearance will trigger an alert (CMAC RWY INCURSION) with an aircraft on short final approach (RIMS).

It is also evident that it will be impossible for some alerts to be triggered at the same moment for the same mobile e.g. a NO PUSH BACK alert will not be triggered for an aircraft on final approach with a NO LANDING alert. While the titles of all alerts are displayed in the ALERT window, only one alert title shall be displayed in the radar/track label and/or the EFS of the concerned mobile. This alert title shall be the one having the highest priority according to requirement defined in the P06.07.01 OSED D32 [9].

5.1.2 Conflicting ATC Clearances detection (CATC)

5.1.2.1 General description and inputs

It is important to note that the term 'Conflicting' in the title refers to the fact that certain clearances input in the system at the same time by an ATCO do not comply with the local ATC rules/procedures, it does not mean that the aircraft/vehicles have ended up in conflict with each other.

The detection of CATC is to provide an early prediction of situations that if not corrected would end up in hazardous situations that would be detected in turn by the RIMS if in operation.

The detection of CATC will be performed by the ATC system and depending on the situation, some or all of the following data will need to be known by the ATC system,

- The clearances given to the mobiles concerned.
- The assigned runway.
- The assigned holding point.
- The route of the mobile/s.
- The position of the mobile/s using Aerodrome Core Surveillance data (e.g. position, velocity, track angle...) correlated to flight plans on the mobiles concerned

The ATCO should therefore be provided with an HMI to input into the ATC system when clearances are given to aircraft or vehicles. The HMI should also be capable of displaying alert messages to the controllers for the CATC detected by the ATC system.

Working procedures for the controllers shall be adapted to ensure that all clearances given to aircraft or vehicles are input in the ATC system by the controller in a timely manner (click/input at the same time as the R/T clearance is given).

founding members



Avenue de Cortenbergh 100 | B -1000 Bruxelles
www.sesarju.eu

Any clearance input in the ATC system will be a triggering event for the ATC system to detect any new CATC.

Different types of CATC are identified and shall be implemented. Some of them are only based on the controller input; others are in addition using other data such as A-SMGCS Surveillance data to confirm that an abnormal situation is detected.

An alert message shall be automatically triggered when conditions matching those described in paragraphs 3.2.2.1 to 3.2.2.16 of the OSED D32 [9] are detected by the ATC system. Validations have identified that there are various ways of indicating CATC to an ATCO. The following examples detail three possible implementation solutions.

1. Prediction of a CATC shown on the EFS.

The HMI can indicate to the ATCO that the clearance if selected will generate an alert. In Figure 5 the potential CATC could be indicated by the appearance of a small orange line on the side of the clearance box (LND being the abbreviation for Cleared to Land). The orange line will disappear when the mobiles are no longer in a position that generates a CATC. If the ATCO selects the clearance with the orange line showing the system can either directly display on the HMI the mobiles that are affected or it can display a window that asks the ATCO the following-CANCEL or ACCEPT (see Figure 6).

CANCEL – this will cancel the last input clearance and remove the confirmation window.

Note: It is expected that this will be the normal procedure and the ATCO will then inform the pilot by R/T that the clearance is cancelled.

ACCEPT – this will close the confirmation window and allow the last input clearance to be accepted by the system. It will be a local implementation issue whether the 2 mobiles are flagged to remind the ATCO of the situation.

Note: This will be at the ATCOs discretion and in specific circumstances only where the ATCO deems it safe to do so. The act of accepting will not prevent other alerts being triggered after the event such as A-SMGCS RIMS. The ATCO inputs will also be recorded so that they can be accessed for replay in case of an actual incident occurring.

PENDING ARR RW27R						
<input type="checkbox"/>	E0810	VDA207	A124/H	I		ROF ▼
<input type="checkbox"/>	E0808	AFR65	A388/J	G		ROF ▼
<input type="checkbox"/>	E0807	FIN5NB	A320/M	I		ROF ▼
<input type="checkbox"/>	E0805	AFR1481	A319/M	G		ROF ▼
FINAL RW27R						
<input type="checkbox"/>	03:28	LGL8011	E145/M	<input checked="" type="checkbox"/>		LND ▼
<input type="checkbox"/>	01:28	FDX4L	MD11/H	<input checked="" type="checkbox"/>		LND ▼
(TD 320/020) RW27R (SE 320/20)						
<input type="checkbox"/>	A0800	UAE73	A388/J	<input checked="" type="checkbox"/>	+++	HOLD AT ▼

Figure 5 – Indication (orange lines) of potential CATCs on an EFS (example only, other implementations of this concept exist)

2. Prediction of the CATC shown in the Pop-Up menu.

This option is as option 1 but does not include the orange line in the clearance box, so the first warning of a CATC will be when the ATCO tries to enter the second clearance and a confirmation window is

foundling members



Avenue de Cortenbergh 100 | B -1000 Bruxelles
www.sesarju.eu

33 of 88

displayed on the screen (see Figure 6). The ATCO will then have the same option as above CANCEL or ACCEPT.

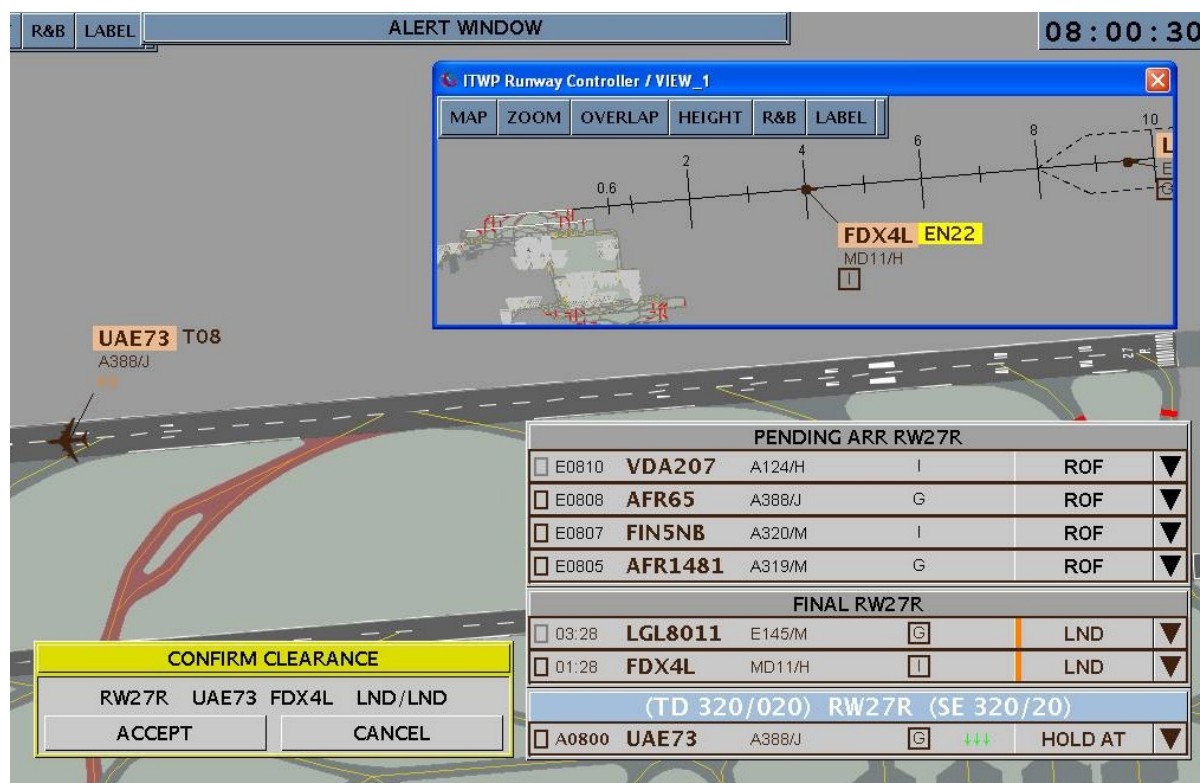

Figure 6 – Indication of a potential CATC in a warning window (example only, other implementations of this concept exist)

3. Display of CATC shown on the A-SMGCS screen.

This option is as option 1 but with no pop up confirmation window, and when the second clearance is input it is directly accepted by the system and the HMI displays the alert in the alert window and on the mobiles affected. The ATCO will have to undo the clearance to cancel the alert.

The method chosen will be a local implementation decision, but the first option is considered favourable due to the fact that the HMI shows any potential CATC without the ATCO needing to make any input therefore less workload is involved than having to make an input and then undo the input.

The following paragraph details the conditions and concerned ATC clearances which apply to the situation where the first aircraft is cleared to Land and the next aircraft is cleared to take off. A full list of the all of the different situations possible can be found in the P06.07.01 OSED D32 [9].

Land vs. Take Off

In the descriptions below, the landing aircraft is the yellow aircraft and the taking-off aircraft is the red aircraft.

Data required – ATC clearances, Assigned Runway/s, Holding Point and Surveillance.

Alert triggered –

1. If the **AZA456** is given Cleared to Land and the **IBE987** is given Cleared to Take Off on the same runway.

founding members



Avenue de Cortenbergh 100 | B -1000 Bruxelles
www.sesarju.eu

34 of 88

- If **AZA456** is given Cleared to Land and **KLM789** is given Cleared to Take Off on the same runway in the opposite direction.



- If **KLM987** is given Cleared to Land and **BAW456** is given Cleared to Take Off on an intersecting/crossing runway.
- If **DLH123** is given Cleared to Land and **BAW456** is given Cleared to Take Off from a converging runway (this alert is required in case **DLH123** performs a missed approach and could conflict with the departing **BAW456**).

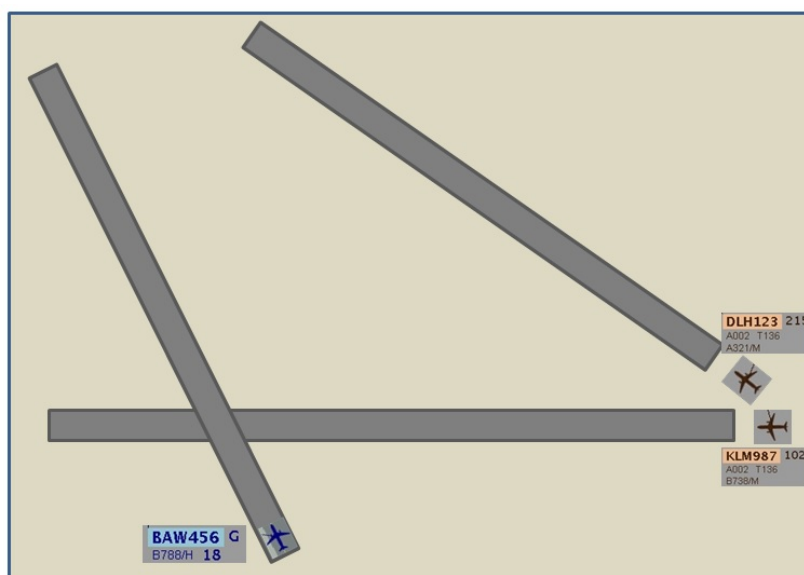

Exemptions to the rule: If LAHSO for **KLM987** is in use then an alert will not be triggered.

At certain airports with closely spaced parallel runways, local procedures may apply if the **EZY577L** is given Cleared to Land and the **TAY123G** is given Cleared to Take Off from the adjacent runway (this alert is required in case the **EZY577L** performs a missed approach it could conflict with the departing **TAY123G** or the wake vortex from the **EZY577L** could interfere with the take-off run of the **TAY123G**).

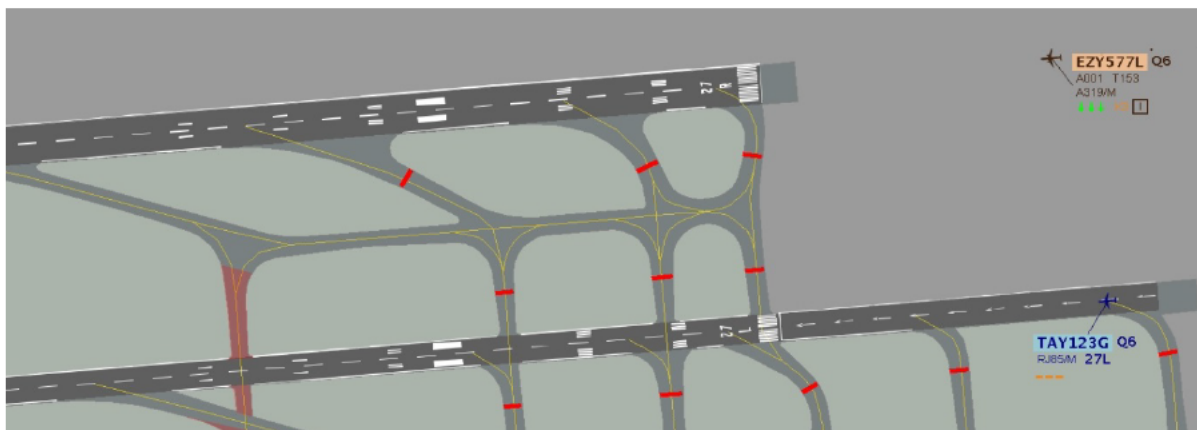

Exemptions to the rule: Local procedures may allow the TAY123G to be given clearance to take off if the EZY577L is at a certain position in which case surveillance is needed to determine the position of the aircraft.

5.1.2.2 Functional architecture

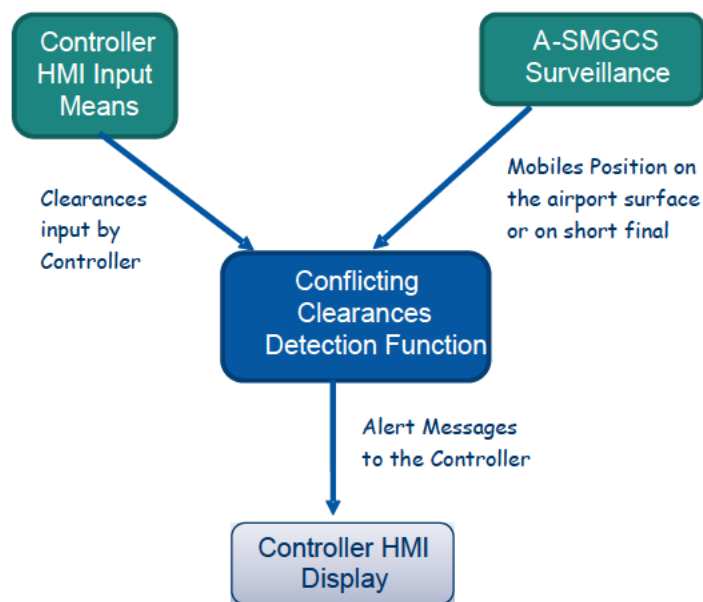

Figure 7 – Conflicting ATC clearances detection – Functional architecture

5.1.2.3 Benefits

The main benefit is the early detection of controller errors that, if not detected and resolved, will result in a hazardous situation.

The following cases do not require A-SMGCS Surveillance data - Line-Up versus Cross/Enter, Line-Up vs. Line -Up, Line-Up vs. Take Off. Therefore this safety feature could be used on airport not having A-SMGCS surveillance operating.

5.1.2.4 Technological enablers

Technical enablers are the Human Machine Interface of the controller that shall provide the means to input the ATC clearances given to mobiles and the A-SMGCS surveillance data (in some cases).

5.1.2.5 Constraints and limitations

Controllers have to make the input of the ATC clearances in the system before or at the same time they talk to the flight crew or vehicle driver.

Airport not A-SMGCS Surveillance equipped will not be capable to implement the cases where surveillance data is required.

5.1.2.6 Assumptions

The Controller HMI is developed so that controller ATC clearances can be input into the system, and alerts generated by the system are presented on the controller HMI.

The airport is equipped with A-SMGCS surveillance in order that the majority of cases of 'conflicting ATC clearances' can be detected while the number of false alerts is minimized.

The ATC system is integrated meaning that the server calculating the possible conflicting ATC clearances has access to A-SMGCS surveillance data.

5.1.2.7 Problems and risks identified

Controllers must make correct and timely inputs into the system; therefore the training aspects are important and necessary to learn new working procedures.

Performance of airport surveillance should be considered when implementing CATC.

5.1.3 Conformance Monitoring Alerts for Controllers (CMAC)

If an alert can apply to either the Tower Runway or Ground Controller then the term controller is used generically.

5.1.3.1 General description and inputs

Alerts are generated by the system when a mobile's (aircraft or vehicle) behaviour is not conforming either to ATC instructions given by the controller (e.g. route deviation) or to ATC procedures as published (e.g. aircraft type not suitable for taxiway or runway).

The inputs of this safety net in the case of non-conformance to ATC instructions are the controller inputs in the system via the Controller Human Machine Interface as well as the Surveillance data from the A-SMGCS Surveillance. The clearance can be a simple instruction e.g. "Line-up" clearance or a more complex instruction such as the "Taxi" clearance which is accompanied with the description of the route to follow. In this last case, the route description is initially known by the system thanks to the A-SMGCS Routing function before the aircraft departs (planned route) and confirmed or amended by the controller when the taxi clearance is given (cleared route).

The inputs of this safety net in the case of non-conformance to ATC procedures are the A-SMGCS Surveillance and elements of the Flight Plan Data, e.g. aircraft flight type that are checked against published ATC procedures.

Below are two examples showing an alert raised for non-conformance to an Instruction and Procedure.

Route Deviation Alert (Instruction)

Data required / Prerequisite – Mobile under control, Taxi Instruction Issued, Surveillance and Cleared Route.

Recommended Text to be displayed on HMI = ROUTE DEV

Alert Type - **Information** or **Alarm** (Local implementation decision e.g. depending on whether the aircraft is deviating within a specified distance and heading towards an active runway)

Alert trigger condition - When the Mobile is detected deviating from the cleared taxi route on the taxiway or entering a runway.

Alert cancelled - When the mobile either rejoins the original taxi route or the ATCO issues new instructions and updates the taxi route via the HMI.

An example of a taxi route deviation is shown in the pictures below, the Cleared taxi route is displayed for 10 seconds to show the ATCO the taxi route the aircraft should be following.

Where alert is displayed - GND or RWY. Dependant on local procedures and position of mobile. E.g. if the taxiing aircraft is close to the runway it could be shown on both GND and RWY positions.

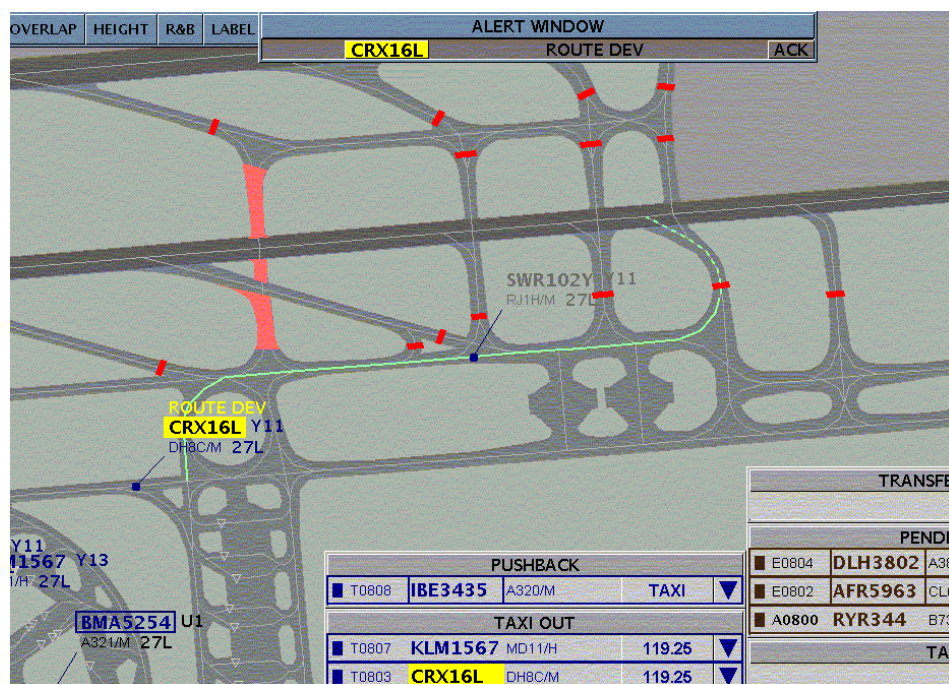

Figure 8 – Conformance monitoring alerts – Example of Route Deviation Alert ‘INFORMATION’

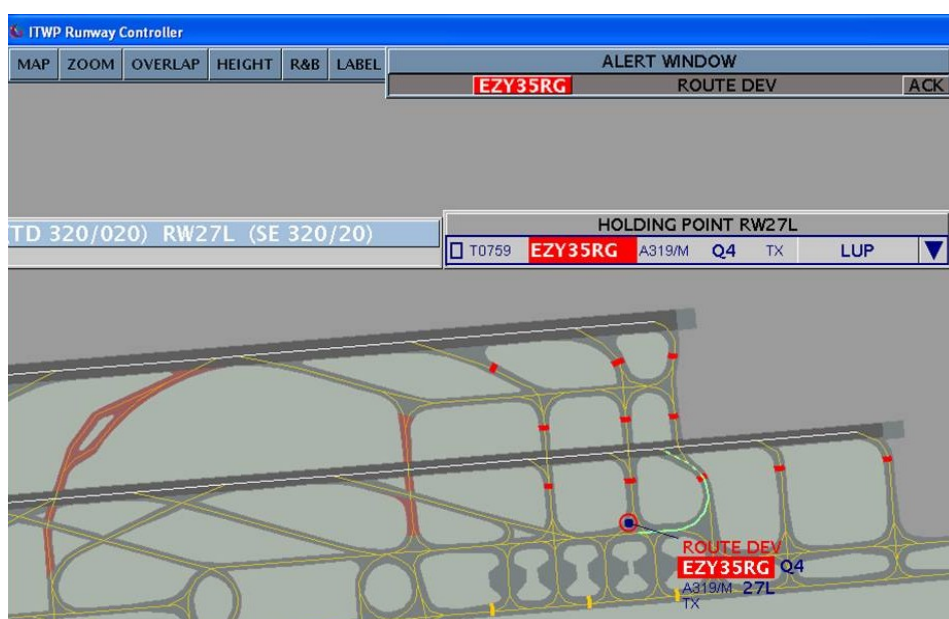

Figure 9 – Conformance monitoring alerts – Example of Route Deviation Alert ‘ALARM’

Runway or Taxi Type (Procedure)

Data required / Prerequisite – Airport procedures, Surveillance, Assigned Runway/Route and aircraft type.

founding members



Avenue de Cortenbergh 100 | B -1000 Bruxelles
www.sesarju.eu

Recommended Text to be displayed on HMI – RWY TYPE or TWY TYPE

Alert Type – **Information** or **Alarm** depending on whether the aircraft is planned to use the runway/taxiway or is actually on the runway/taxiway

Alert trigger conditions – When the cross check to see if the runway or taxi route is suitable for the aircraft type is negative

Alert cancelled – When the aircraft is assigned a different and suitable runway or taxiway.

Where alert is displayed –

1. For Runway type non conformance, It is likely that this alert need only be displayed on the Tower Runway Controller's HMI
2. For Taxiway type non conformance, It is likely that this alert need to be displayed on the Tower Runway and Ground Controller's HMI

5.1.3.2 Functional architecture

Figure 10 – Conformance monitoring alerts – Ground functional architecture

5.1.3.3 Benefits

The main benefit is the early detection of flight crew / vehicle driver errors that, if not detected and resolved, will result in a hazardous situation.

5.1.3.4 Technological enablers

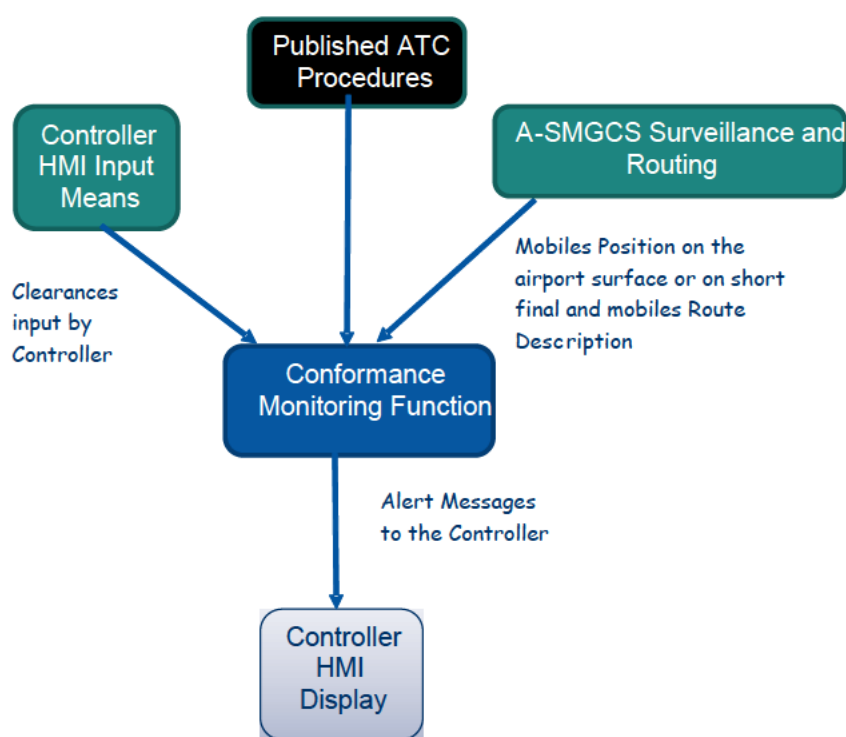
Technical enablers are the Human Machine Interface of the controller that shall provide the means to input the instructions given to mobiles, the A-SMGCS surveillance data and the output of the A-SMGCS routing function (P06.07.02).

5.1.3.5 Constraints and limitations

Controllers have to make the input of the instructions in the system before or at the same time they talk to the flight crew or vehicle driver. The cleared route given by R/T by the controller to the flight crew has to be the same as the route in the system. The published ATC procedures have to be programmed in the server.

5.1.3.6 Assumptions

The Controller HMI is developed so that controller instructions can be input into the system and alerts generated by the system are presented on the controller HMI.

The airport is equipped with A-SMGCS surveillance. The A-SMGCS routing function is providing the system with the mobile cleared route description of the airport surface. The ATC system is integrated meaning that the server calculating the possible non-conformance cases has access to A-SMGCS surveillance and routing data.

5.1.3.7 Problems and risks identified

Controllers may not input the instructions in the system; therefore the training aspects are important and necessary to learn new working procedures.

Performance of surveillance should be considered when implementing CMAC.

5.1.4 Integration of safety support tools for controllers

5.1.4.1 General description

As mentioned earlier in section 2.2, A-SMGCS Levels 1 and 2 have been implemented in several European Airports and provide a safety net based only on surveillance data (it does not take into account instructions given by the controllers).

The new alerts for conflicting ATC clearances and conformance monitoring aim to build on the RIMS experience and provide controllers with alerts that are more predictive than reactive; in order to complement the RIMS that will still trigger last minute alerts but hopefully any conflicting situation can be prevented before the RIMS is triggered.

With the exception of a handful of conflicting ATC clearances that just require the EFS, all of the new alerts require EFS and A-SMGCS surveillance. The conflicting ATC clearances and conformance monitoring alerts can be implemented independently with A-SMGCS surveillance, but to gain the maximum level of safety it is also recommended to have A-SMGCS RIMS as well.

5.1.4.2 Interactions

As previously mentioned, the new CATC and CMAC alerts described in P06.07.01 OSED D32 [9] are not meant to replace RIMS but to complement RIMS by predicting incidents before the RIMS Alerts trigger. While the processing of RIMS, CATC and CMAC is independent, in certain situations it will be possible for more than one alert to be triggered for the same mobile e.g. an aircraft LINING UP with no clearance will trigger an alert (CMAC RWY INCURSION) with an aircraft on short final approach (RIMS). Therefore possible interaction shall be managed according to requirement defined in the P06.07.01 OSED D32 [9] related to "Priorities" of alerts.

5.1.4.3 Benefits

Even if not integrated, these safety support tools are complementary and thus a full implementation would reinforce the safety barriers to prevent collisions to happen.

CATC and CMAC will complement A-SMGCS RIMS by providing earlier alerts to the controller. For instance, CMAC will detect a runway incursion and alert the controller while there is still no conflict with another aircraft in the Runway Protected Area (A-SMGCS RIMS).

5.1.4.4 Constraints and limitations

Not applicable.

5.1.4.5 Assumptions

If "Detection of conflicting ATC clearances" and "Conformance monitoring alerts" are both implemented, then they should have the same reference source of the clearance to assure the same timing for calculations.

5.1.4.6 Problems and risks identified

Performance of airport surveillance should be considered when implementing CMAC and CATC.

The following potential issue has been identified and will need to be addressed during validations:

- **The ATCO may have to override a CATC indication to resolve another alert**

founding members



Avenue de Cortenbergh 100 | B -1000 Bruxelles
www.sesarju.eu

42 of 88

In the case of conflict between a taking off aircraft (with clearance) and a crossing aircraft (without clearance), it can be assumed that the logic would be for the ATCO to instruct the taking off aircraft to abort take-off and to instruct the crossing aircraft to expedite vacating. Having made his mind about this decision, the ATCO may see the CATC indication, telling him that a CROSS clearance will be in conflict with another clearance. The ATCO may doubt about his decision at a critical time (A-SMGCS and/or CMAAC alerts are also triggered) but, more importantly, the ATCO will have to ignore (override) the CATC indication. Also, after a conflict, it could be difficult to analyse the level of contribution of CATC indication in a runway incursion resolution by ATC.

The following mitigation means could be envisaged:

- CATC is disabled (on concerned aircraft) as soon as there is an A-SMGCS RIMS alert.
- Based on the above example, remove the CATC indication on the CROSS clearance for the crossing aircraft by taking account of surveillance data.

5.2 Tools for flight crews

5.2.1 Runway Status Lights (RWSL)

5.2.1.1 General description and inputs

5.2.1.1.1 Runway Entrance Lights (RELs)

A risk of collision on the runway may occur when an aircraft or vehicle enters the runway when another aircraft occupies it. This might occur if the flight crew or vehicle driver misunderstands his position or his clearance or if a controller gives a clearance without realizing the runway is occupied. The RWSL System prevents this situation by detecting the presence of the occupying traffic and automatically illuminating RELs at the entrance point onto the runway.

RELs illuminate red when the runway is unsafe to enter, use or cross (high speed operation on-going: take-off or landing). They are off otherwise.

The RELs are extinguished just before the high-speed operation passes the intersection. Thereby, airport operations are not disturbed: controllers may anticipate their clearance by allowing a mobile to start moving.

The following table describes how RWSL processor determines when RELs should turn on and off.

Aircraft behaviour	Stopped on the runway awaiting take-off clearance	Begins departure	Becomes a high-speed operation	Passes taxiway intersections	Rotates and begins climbing
RELs	OFF	ON for close intersections OFF for distant locations	ON	OFF for close intersections (To allow control anticipation) ON for the other distant intersections	All OFF

Table 3 – RELs logic

5.2.1.1.2 Take-off Hold Lights (THLs)

There may be a risk of collision if an aircraft attempts to take off when an aircraft or vehicle is occupying the runway. This might occur if the deviating flight crew or vehicle driver misunderstands his position on the airport movement area or if a controller gives a take-off clearance without realizing the runway is occupied or if a flight crew incorrectly believes he is cleared for take-off. The RWSL System prevents this situation by detecting the presence of the occupying traffic and automatically illuminating THLs in front of the taking-off aircraft (where the departing aircraft begins its take-off acceleration). Illumination of the THLs will indicate to the flight crew that runway is unsafe for departure and he has to stop immediately or not start to roll for take-off.

THLs illuminate red when the runway is unsafe for departure because it is currently occupied or about to be occupied by entering or crossing traffic; they are off otherwise. In order not to interfere with the normal flow of airport traffic, the THLs are extinguished just before the blocking or crossing traffic is outside the runway triggering area, when it is safe for the departure to commence. THLs are only

illuminated when an aircraft turns into position and hold on a runway and another mobile occupies the runway in front of it.

The logic of THLs activation/deactivation is described in [8].

5.2.1.2 Functional architecture

The RWSL System consists of an RWSL processor and a Field Lighting System (FLS). The RWSL processor receives surveillance data from the surface surveillance system. The RWSL processor uses this surveillance data to determine when to activate and deactivate the RELs and THLs. These light commands are sent to the RWSL FLS. The FLS illuminates and extinguishes the lights as commanded by the RWSL processor. The system will also receive runway status (open, occupied or closed) and will adjust the activation and deactivation of RELs and THLs accordingly.

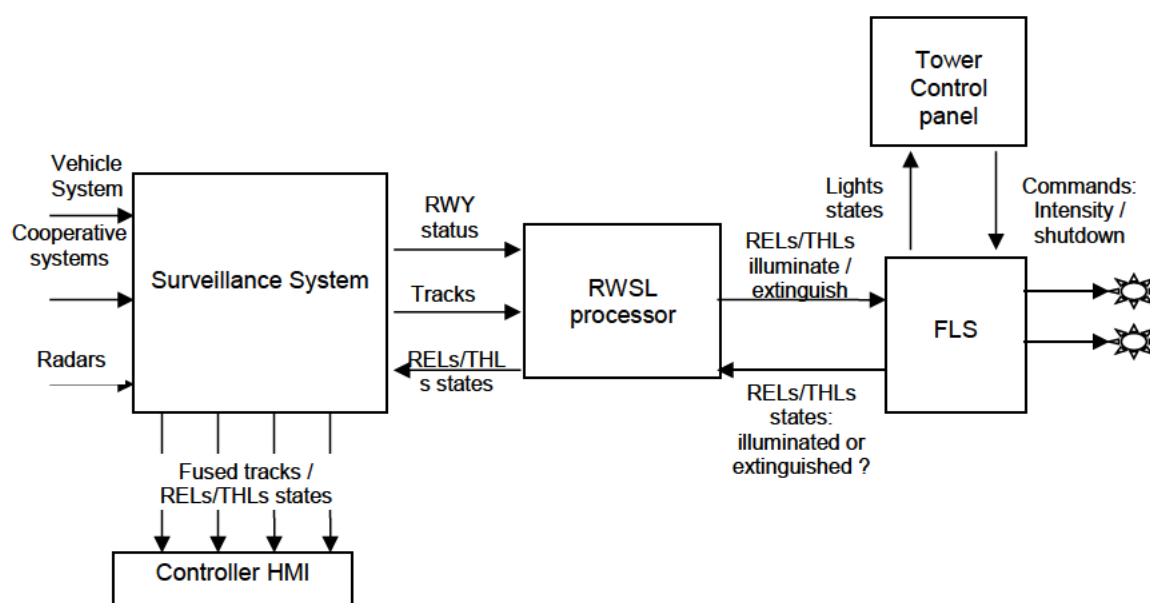

Figure 11 – RWSL system

Air Traffic supervisors can manage the system using a tower control panel. They will control light intensity (override of automatic intensity adjustment) separately by RELs and THLs and by runway.

RELs and THLs status (on or off) will be also shown on A-SMGCS Controller Working Position. Controllers have to be aware of the situation on the field.

5.2.1.3 Benefits

Flight crews have generally a limited knowledge of their surrounding environment and it is difficult for them to understand the situation in a little time. Regarding runway incursions of vehicle drivers, there may be several reasons: particular demands, misinterpretation of the authorization, or unfamiliarity with procedures. Furthermore, conflicting clearances by the Tower Runway Controller can also lead to a risk of collision during runway operations.

As described in the baseline tools (section 2.2.1), A-SMGCS RIMS provides controllers with a runway safety net. By addressing directly flight crews and vehicle drivers, the RWSL system could reduce the number and the severity of these runway incursions and prevent runway accidents.

Flight crews and vehicle drivers are directly warned up of the danger of their situation; they do not have to wait the analysis of the controller. They receive directly from the system the order of stopping/not starting their moving and then, they have to contact the controller to know what they now have to do

5.2.1.4 Technological enablers

Technical enablers are

- the Human Machine Interface of the Controller that shall show the status of lights and enable the Controller to kill the process in case of malfunctioning of RWSL system;
- the A-SMGCS Surveillance data in input (tracks and runways status); and
- the field lighting system: REL and THL lights (possibly with LED technology) and automaton.

5.2.1.5 Constraints and limitations

The setting of all algorithms should be carefully investigated so that the number of false alerts is kept to a minimum/accepted level.

5.2.1.6 Assumptions

The airport is equipped with A-SMGCS Surveillance.

5.2.1.7 Problems and risks identified

The problems and risks identified for RWSL are as follows:

- Issue related to the coexistence of RWSL and stop bars. In order to not disrupt normal operations the parameters for RELs and THLs activation / deactivation need to be tuned so that RELs and THLs operation is not in conflict with the stop bar activation.
- Non-adequate RELs/THLs switching on/off. As status indications are directly addressed to flight crews and vehicle drivers, they have to be timely visible to flight crews/ vehicle drivers. This system needs to be very well tuned before its operational use in order to not interfere with airport operations. This tuning could take a long time.
- Non-adequate accuracy and integrity of position, speed and acceleration information from the surveillance system for RWSL system. As warnings are directly addressed to flight crews and vehicle drivers, they have to be appropriate. This implies that input data, i.e. surveillance data, need to be sufficiently precise and have an adequate integrity for RWSL.
- RWSL would represent an additional RWY safety net that would be added to RIMS aiming to address the same conflict but delivering the warning to two different final users. This could introduce some issues, as detailed in section 5.4.3.
- Installation. (experience from FAA installations)
- Integration of RWSL system will impose significant costs in terms of:
 - infrastructure installations;
 - developing/revising operational requirements (which are adapted to each airport);
 - training for flight crew, vehicle drivers and controllers; and
 - maintenance

5.2.2 Conformance monitoring alerts for flight crews

5.2.2.1 General description and inputs

The principle of Conformance monitoring alerts is to detect inconsistencies between the aircraft characteristics, its environment and the expected operations. An exhaustive description is provided hereafter, but it should be noted that few functions can be the object of a future implementation because a main enabler is not available: datalink provision of runway status.

5.2.2.1.1 Taxiway compatibility

This occurs when a selected taxiway is inappropriate / unsuitable with regard to the aircraft type, i.e. taxiway capabilities do not match the aircraft characteristics like wingspan, width, ACN/PCN (Aircraft/Pavement Classification Number).

A taxiway not suitable for the aircraft is a situation where the taxiway must not be used by the aircraft according to existing rules:

- Aircraft Classification Number (ACN)
- Aircraft wingspan

This information can be usually found on charts and could be reported to the crew via information on a moving map to be used as a reminder.

In addition, alerts are envisaged:

- when the aircraft is entering or is about to enter the concerned taxiway.
- when a pilot manually inserts a taxi route containing an inappropriate / unsuitable taxiway.

In this case, the pilot should contact ATC to confirm the taxi route or ask for a new taxi route.

For taxi-in, this information should be presented to pilot before top of descent if it is available because during final approach phase flight crew has a high workload to treat this kind of information.

Once the alert is triggered, several actions could be expected:

- The crew stops or slows down the aircraft and checks the map
- Then depending on the configuration,
 - They adjust the trajectory and resume taxiing
 - Or in case of doubt contact ATC to confirm their position and/or taxi route

Inputs:

- Airport map data base with PCN information (currently part of it)
- Aircraft current data (position, speed, heading) and ACN.

Enabler: PCN information is already an attribute defined in airport database.

5.2.2.1.2 Runway Type

This is similar to the Taxiway compatibility when a selected runway is inappropriate / unsuitable with regard to the aircraft type.

founding members



Avenue de Cortenbergh 100 | B -1000 Bruxelles
www.sesarju.eu

Depending on implementation, when the crew selects an inappropriate / unsuitable runway and the aircraft system detects the runway is not suitable for this aircraft, an alert is triggered. The crew action is then to check if the right runway was entered. The pilot can then either confirm the runway if an authorization was obtained from airport authorities during planning or ask ATC for another runway to land / take-off.

5.2.2.1.3 Taxiway closed

This is to alert the crew when a taxiway (or taxiway segment) is temporarily unusable (e.g. when works are in progress) and declared as closed within the system but the aircraft is assigned to use that taxiway or is on that taxiway.

A closed taxiway is similar to a closed runway in terms of procedure (it should not be used), so it needs to be known by on-board systems.

Then this information could be reported to the crew by:

- Information displayed on the moving map,
 - In this case, if the crew has noticed the information, they are expected to take care in order to avoid any error of navigation,
- An advisory alert to make pilot aware about a closed taxiway if he manually inserts a taxi route containing a closed taxiway.
 - In this case, pilot should contact ATC to confirm the taxi route or ask for a new taxi route.
- Two different levels of alerts: (1) warning alert when the aircraft enters and (2) advisory alert when it is about to enter on the concerned taxiway (or taxiway segment)
 - With assumption that the alert can be triggered early enough, the crew can stop or slow down, check with information on the moving map provided by uplinked ATIS and NOTAM.
 - In case pilot is following a taxi route manually inserted, no alert would be triggered because flight crew has already been notified about the issue.

Note: Such a function cannot be developed as long as D-OTIS including ATIS and NOTAMs is not deployed. No target date is planned.

5.2.2.1.4 Runway Closed/Shortened

This is to alert the crew when a selected runway is declared as closed or it is shortened within the system and an aircraft is assigned to use that runway or is on that runway.

To be feasible, such a function relies on information found in NOTAMs or ATIS and in Airport database. A condition is the format compatibility, so that the information can be interpreted on board (concerned runway, runway status, time slot, shortened distance ...).

Two levels of information are considered:

- Information on a moving map to be used as a reminder,
 - they are expected to acknowledge the information, and particularly take care in order to avoid any error of navigation
- Information about compatibility issues on the runway (i.e. shortened runway) should be available before the final approach, when preparing landing, in order to enable better

anticipation of the landing and reduce uncertainty (e.g. last minute change of landing runway) in final approach and keep an acceptable level of workload.

- Only information level is considered for this case as it is not a limitation that prevents flight crew to take off or land on concerned runway.
- Warning alert when the aircraft is entering on the closed runway.
 - With assumption that the alert can be triggered early enough, the crew can:
 - stop or slow down,
 - check with information on the moving map provided by uplinked ATIS and NOTAM,
 - in case of doubt contact ATC to confirm their position and/or taxi route and/or runway clearance,

No alert when aircraft is entering / landing on a shortened runway. Runway shortened is not a limitation which should prevent aircraft to land or take-off on it. *In case runway is too shortened and aircraft is not capable to take off on it, other functions (TOS) already exist to prevent flight crew from taking-off.*

Note: Such a function cannot be developed as long as D-OTIS including ATIS and NOTAMs is not deployed. No target date is planned.

5.2.2.1.5 Deviation from the cleared Taxi route

It consists in monitoring when the aircraft deviates from the route if cleared by the controller.

Such situations can create an operational disturbance like a loss of time, disturbance of traffic on ground etc., or in the worst case lead to a runway incursion and a possible impact on safety (like Linate accident).

The cleared taxi route could be provided by data link or manually entered by the flight crew to be displayed for pilots on a moving map.

Alerting intends to support crews for monitoring and detect when the aircraft is deviating from the route without being requested.

Once the crew realizes that they have deviated from the taxi route by error, they inform ATC in order to resume a new taxi route.

Such a function is for use on taxiway only because ATC clearances to operate on runways are only available by voice and not by data link.

Inputs:

- D-TAXI route and clearance provided by ATC
- Manual entry by flight crews of taxi route provided and cleared aurally by the controller
- Aircraft data (position, speed, heading).

5.2.2.1.6 Take-off from a taxiway

When the crew initiates take-off as the aircraft is on a taxiway (not being aware of their situation).

Such events may occur due to a loss of crew awareness or because of confusion when the taxiway is a former runway.

founding members



Avenue de Cortenbergh 100 | B -1000 Bruxelles
www.sesarju.eu

Depending on implementation, when the crew takes-off (aircraft in take-off configuration, high speed) and the aircraft system detects the aircraft is not on a runway, an alert is triggered. The crew action is then to reduce speed and abort take-off.

General remark: the use of these functions does not change current principles that remain applicable up to now especially the moving map and associated information (taxi route, aircraft, alerts) are for monitoring use. The reference remains the published chart on paper or any un-corrupted display presentation.

This function is not coupled with the equivalent function developed for controllers described in 5.1.3. Associated tuning and procedure should be checked against “Conformance Monitoring” alerts for controllers (see section 5.4.2.1).

Inputs:

- Aircraft configuration (take-off)
- Runway data
- Aircraft position

Note: this function is already implemented on some aircraft.

5.2.2.2 Functional architecture

In this section, an on-board functional architecture is presented.

On this schematic, boxes represent on-board functions (inside the grey area) and arrows the flow of data.

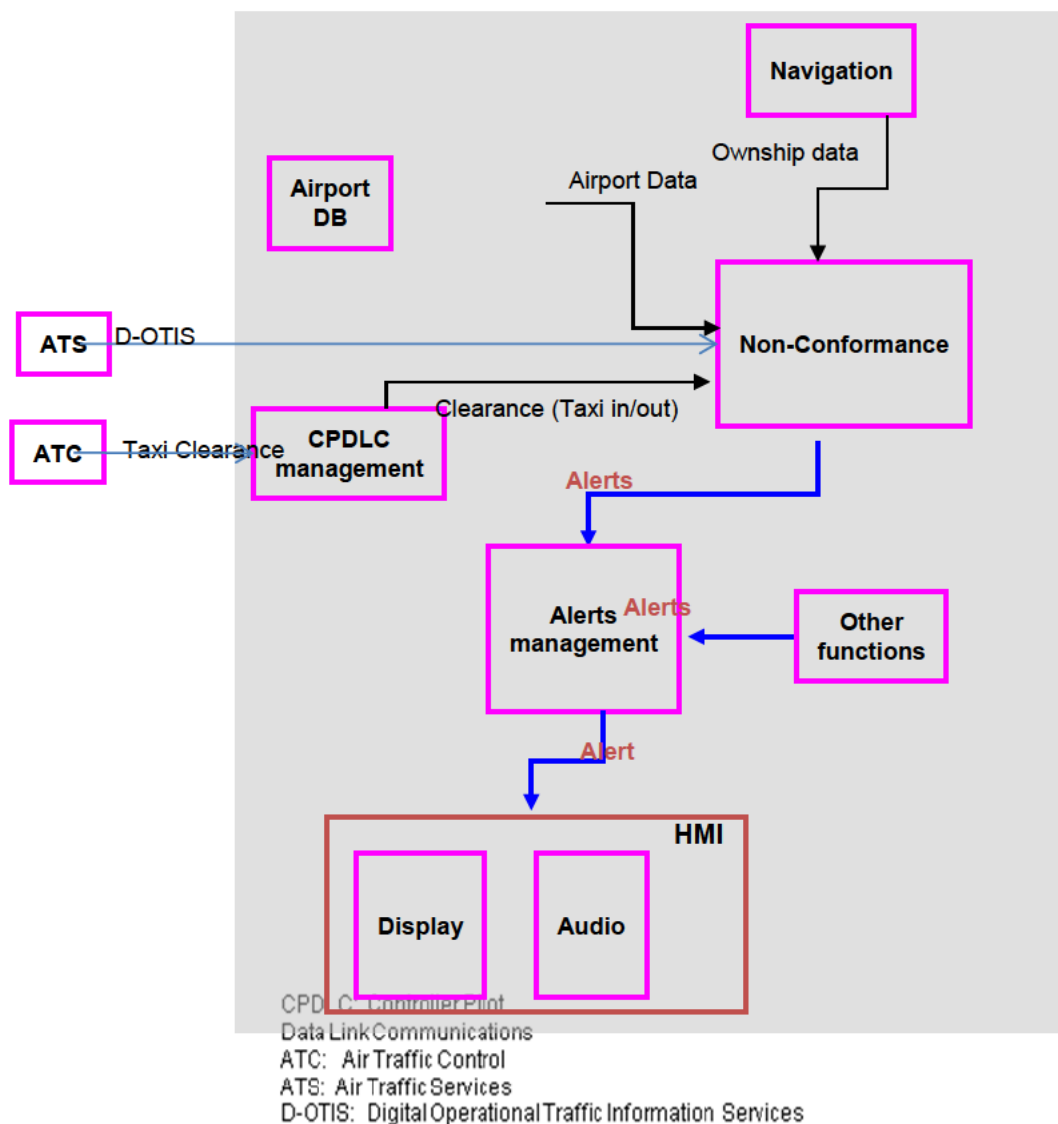

Figure 12 – Functional architecture for conformance monitoring alerts for flight crews

5.2.2.3 Benefits

Benefits expected from alerts are of two types:

- Safety when preventing aircraft from a runway incursion or take-off from a taxiway,
- Economical by avoiding: traffic conflicts, jammed traffic caused by aircraft entering a wrong taxiway and being unable to come back to its initial route.

The counterpart that will be assessed is the impact of modifications and their cost:

- Get data link information (not specific of Conformance Monitoring functions),
- Specific: “Alerts Management” function which has an impact on the Airport Moving Map system.

5.2.2.4 Technological enablers

The main enablers are for an on-board function:

- Taxiway data to be available in on-board airport databases,
- Data link service providing airport temporary limitations,
 Note: This service is not part of the next Release A of WG78/SC214 Baseline 2 standards (objective for publication is early 2016).
- Data link for getting the route from the gate to the runway (or the other way) and the clearance,
 Note: This service is already defined in WG78/SC214 Baseline 2 Standards Initial Release published in April 2014.
- Aircraft information (position, speed, track, etc.).

5.2.2.5 Constraints and limitations

There are constraints associated with technological enablers.

- Airport data
 The constraint is to retrieve information and update it to have a function complying with the current situation.
- Airport status via data link
 In addition of the communication, it is expected to have formatted information that can be interpreted by the on-board system. Current standardization (EUROCAE WG78) provides only free text information and no deployment is planned today.
- Deviation from Taxi route
 There are possible limitations that can make an alert difficult to be determined if it relies on a data link path reflecting the textual clearance. There may be difficulties to interpret if the aircraft is deviating from the taxi route because of drawing issues.

 An operational limitation linked to the data link clearance is that it is not envisaged to send ATC clearances for runway crossing, lining-up and take-off by data link. This prevents from monitoring if the clearance is respected or not (as done by tools for controllers).

5.2.2.6 Assumptions

Assumptions are made that:

- ATC clearances will still be given by voice where safety impacts can be important i.e. when it deals with operations on runway. This is also a factor of efficiency to manage the flow of aircraft without communication delay,
- There is no major obstacle about getting airport data because they already exist and airport data new format make it possible to implement them,

5.2.2.7 Problems and risks identified

In relation with the previous considerations, problems are related to technological issues in §5.2.2.4 and 5.2.2.5.

5.2.3 Traffic alerts for flight crews

5.2.3.1 General description and inputs

The Traffic Alerts function aims to detect a current or potential risk of collision in the runway envelop or on taxiways between two aircraft or between one aircraft and one vehicle, including the aircraft at the end of final approach.

5.2.3.1.1 Traffic alerts on runway

A risk of collision can occur when errors have occurred like:

- clearance misunderstanding not detected by the ground tools/controllers involving a runway incursion as another aircraft is already operating on this runway;
- conflicting ATC clearances leading two aircraft to operate on the runway at the same time.

This function is a safety net so it does not supersede current procedures (e.g. on-board checks, communication between aircraft and controllers, out the window scan).

Traffic alerts for flight crews are to be used by aircraft equipped with ADS-B IN. It may also utilize ground infrastructure such as Traffic Information Service – Broadcast (TIS-B) or Automatic Dependence Surveillance Rebroadcast (ADS-R).

The inputs of the function are:

- Ownship information,
- Other mobile information,
- Runway information

No link with ground services is needed.

The following reference situations are described in the OSED:

- The ownship is on approach with an aircraft on runway,
- The ownship is on a taxiway bound for the runway and there is an aircraft operating on the runway,
- The ownship is on runway, possibly lining-up for take-off and other aircraft are entering the runway,
- The ownship is in take-off position and another aircraft is operating on the runway.

One can add specific situations with crossing runways and procedures like LAHSO.

Two types of flight deck implementation are currently envisaged to reach the above objective.

However, none of them currently considers conflicts with ground vehicles. The main reason is that ground vehicles are not equipped with an appropriate equipage with the required performances. This situation could change in the future due to some actions e.g. from FAA.

First type of flight deck implementation

This implementation is following closely the one proposed in RTCA DO-323 i.e.:

- It assumes that CDTI is available to display ground traffic,

founding members



Avenue de Cortenbergh 100 | B -1000 Bruxelles
www.sesarju.eu

- From RTCA DO-323, it is proposed (excerpts from DO-323 SURF IA Appendix A):
 - “Indications are provided for traffic in normal operational conditions”
 - **Runway Status Indications (RSI)** are provided if the flight crew should verify runway status prior to proceeding. RSI is associated with information about the concerned runway.
 - **Traffic Indications (TI)** are provided if there is no immediate collision hazard with ownship but a collision hazard could develop over some time. TI is associated with information about concerned traffic.
 - “Alerts are provided in case of non-normal operational conditions”. “SURF-IA alerts are intended to help prevent collisions between 2 aircraft”
 - **Warning level** in situation of imminent collision risk.
 - **Caution level** also requires immediate flight crew awareness.
 - Advisory alerts are not used in this concept because indications are expected to cover situations where, as it is the case for advisory alerts, no immediate awareness is required by the flight crew.

Second type of flight deck implementation

The proposed implementation is based on:

- A reduced set of alerts,
- The possibility to implement either a subset of alerts or a full set of alerts depending on the aircraft equipage.

Advisory: This alert is triggered when a risk of collision comes up leaving a few seconds of margin to analyse the situation with an airport moving map (ATSA-SURF). It may require subsequent flight crew response depending on the context or on crew judgment or on ATC action that can be:

- Continue if it is assessed that there is still time to see how the situation evolves (The crew can call ATC for confirmation)
- A small corrective action like decelerating - when on ground - so that a collision may not occur,
- An avoidance action if it is confirmed that there is no chance for the risk to disappear (e.g. a Go-around if ownship is in approach and a mobile remains stopped close to the runway threshold).

If no corrective action is made, this alert can be followed by a Warning.

Characteristics of the Advisory rely on the presentation of visual information about traffic causing the risk of collision on the Airport Moving Map.

On the difference with a Caution which is based on similar conditions, no audio is triggered.

Referring to DO-323 A.2.1.4, “Caution alerts are presented unless they would cause unacceptable distraction during high workload and time critical situations.”

Warning: When there is a risk of collision in a short time, a warning level is triggered in order to require immediate flight crew awareness and an immediate flight crew response.

Caution level has not been used. Normally, it is used for “immediate” awareness and is followed by a warning if no corrective action has been made.

Note: In the frame of SESAR P9.14, the focus of V3 validations on that second type of implementation has been set on the Warning level only.

5.2.3.1.2 Traffic alerts on taxiway

Traffic alerts on taxiways have recently been initiated to prevent collision during the taxi phase (In and Out).

Alerts during taxi phases address mainly the operational consequence of collision at lower speed like:

- At airline level: damages that can cause flight cancellation, passenger transfer, maintenance action on an aircraft that becomes temporarily unusable,
- At airport level: it creates disturbances on traffic with associated delays.

This alerting function is intended to assist the flight crew in reducing probability of a taxiway incursion. The system achieves its intended function by providing the flight crew with timely information on the location and proximity of potential threats on taxiways. The system provides visual indications on the airport moving map display and issues aural alerts to assist the flight crew in resolving the conflicts.

Levels of alert:

- Indication level
- Caution level

5.2.3.1.2.1 Traffic indication on taxiway

The purpose of traffic indications on taxiway is to highlight 'close' traffic to ownship. Any traffic within the ownship circular relevant zone is indicated as Relevant Traffic. Relevant traffic differs in colour.

5.2.3.1.2.2 Traffic alert on taxiway

The caution level alert is triggered when the alerting algorithm detects that the Relevant Traffic converges to ownship and evaluates it as a potential threat according to its current movement heading and speed.

The Traffic Alert is provided consistent with AC 25.1322-1 and DO-317A.

The position of the potential threat is assessed by the system as follows as depicted in Figure 13:

- "Traffic Left": Relevant Traffic relative bearing from ownship is between -45° and -135° ;
- "Traffic Right": Relevant Traffic relative bearing from ownship is between 45° and 135° ;
- "Traffic Ahead": Relevant Traffic relative bearing from ownship is between -45° and $+45^{\circ}$;
- "Traffic Behind": Relevant Traffic relative bearing from ownship is between 135° and -135° .

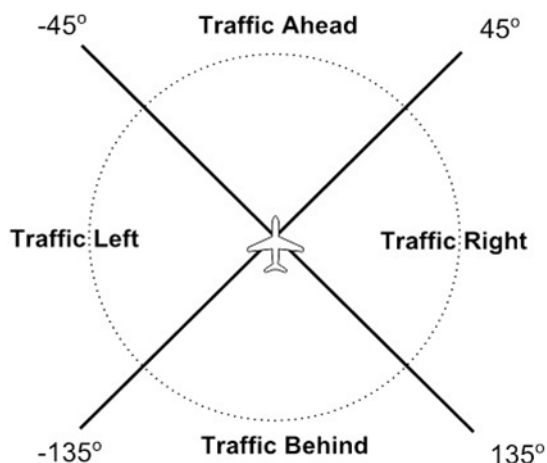

Figure 13 – Scheme of Relevant Traffic position assessment in relation to ownship

5.2.3.2 Functional architecture

On this schematic, boxes represent on-board functions (inside the grey area) and arrows the flow of data.

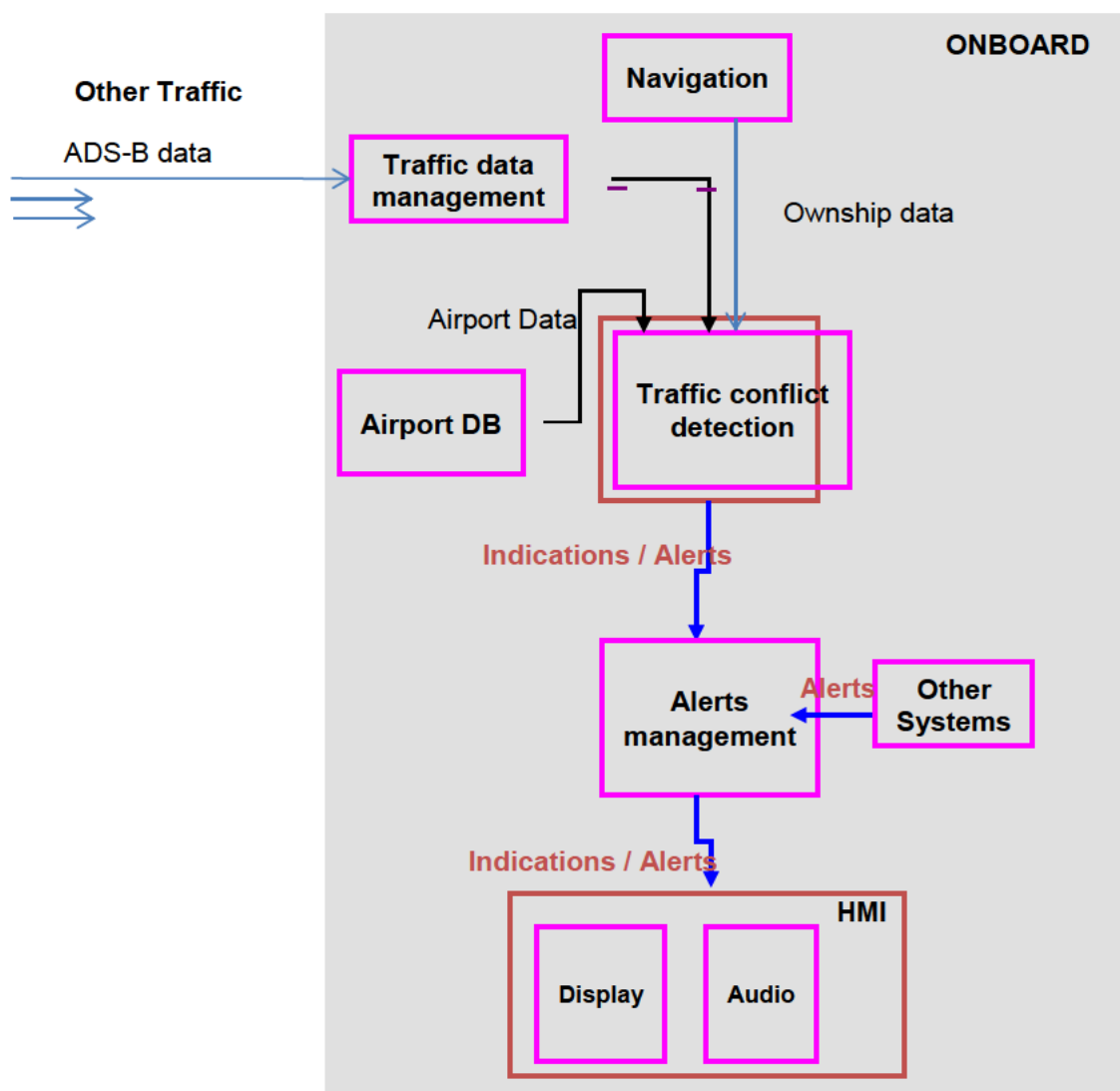

Figure 14 – Functional architecture for traffic alerts for flight crews

5.2.3.3 Benefits

The traffic alerts will support the flight crews in the detection of a potential or actual risk of collision if they have not yet detected it using current source of information (i.e. out the window, radio communication listening, traffic display).

In comparison with the alerts triggered to the controllers by A-SMGCS RIMS systems, they allow quicker actions as there is no need for radio communications to inform the flight crews about the risk of collision.

As traffic alerts are focussed on runway risks, the expected benefits are firstly focussed on safety i.e. to avoid aircraft collision within high energy conditions.

In addition, apart from the safety gains, impact on traffic movements may be limited by anticipating conflicting situations. For example, preventing an aircraft from entering on a runway where another aircraft is taking off or landing would cause less delay than coping with an aborted take-off or a go-around.

Other economic aspects linked with damages caused by light collisions at low speed on aprons or taxiways without safety effects are not addressed here.

The counterpart that will be assessed is the impact of modifications and their cost:

- Specific impact of “Alerts Management” function that can be on TCAS and Airport Moving Map system.

5.2.3.4 Technological enablers

Involved enablers for an on-board Traffic Alerts function are mainly:

- Information about other mobiles provided by ADS-B,
- Information about ownship (including mostly position, speed, track),
- Information about runway location as provided by various databases embedded in on-board systems (OANS/Moving Map, FMS, TAWS, etc.)
- Conventional systems like Display System, Warning System, etc.

5.2.3.5 Constraints and limitations

A constraint is the percentage of ADS-B equipped mobiles that can provide the ownship with data for conflict detection with the appropriate level of quality.

To be able to be taken into account in the triggering of the traffic alerts, the ground vehicles operating in the manoeuvring area must be equipped with certified ADS-B systems.

A potential limitation is the data quality transmitted by the surrounding mobiles. If minimum requirements on data transmitted by other aircraft are not met, there will be an impact on the conflict detection rate (actual conflict detected) and/or the rate of spurious or untimely alerts (causing unnecessary manoeuvres). This is one of the reasons why ground vehicles are not considered.

5.2.3.6 Assumptions

An assumption is to have a significant amount of mobiles equipped with transponders transmitting ADS-B data, to feed an alert function. The implementation of ADS-B has already started.

5.2.3.7 Problems and risks identified

A risk is the number of false alerts because it could disturb crews by attracting their attention and provoke inadequate reactions during normal operations. This can lead to reject the concept.

A problem is the way to validate such a function when used close to runways. It should reach a correct level of validation on simulator with realistic scenarios before going to flight tests.

5.2.4 Integration of safety support tools for flight crews

5.2.4.1 General description

This section addresses the integration of on-board safety tools for flight crews and considers the 3 above topics that are used directly by pilots:

- Conformance monitoring for Pilots (CMAP) used both on taxiways and runways,
- Traffic alerts for pilots,
- Runway Status Lights (RWSL) including RELs and THLs.

Some common principles of operational integration rely on:

- the flight crew tasks remain unchanged and current procedures are to be followed,
 - in other words, it means that flight crews are not supposed to rely on alerts as a primary means for avoiding risks of collision.
- the new functions must not be intrusive.
 - It does not create additional tasks for pilots like information to be permanently monitored

5.2.4.2 Interactions

To identify interactions, a review of context is presented hereafter to determine when each safety tool is used and if in given situations, there may be active together:

- **At the gate:** only conformance monitoring functions are active by presenting information about taxiways and runways that are closed or unsuitable to the aircraft. If a taxi route is available, there can be an alert to inform the flight crew about discrepancies or errors if the taxi path goes through an inappropriate taxiway.
- **During taxi-in/out:** conformance monitoring functions are active by presenting information about taxiways. Monitoring functions are used to detect deviations from the cleared path and to check if the aircraft enters a non-authorized taxiway. Traffic alerts on taxiways are considered in P09.14 and subject to validations together with conformance monitoring functions. During taxi, Conformance Monitoring and traffic alerts provide both more awareness to pilots. Flight crew reactions to both types of alerts can lead to similar manoeuvres like “Stop” in case of doubt, to avoid entering a wrong taxiway or to avoid a collision.
- **When approaching the runway at the end of taxi out,** we may have in the following order:
 - Information about runway status because it is either permanent if it deals with compatibility or already announced if it is a matter of status.
 - If airport equipped, Runway status lights (REL) to inform that the runway is occupied or not.
 - Then, in case of error and if an aircraft is operating on the runway, when the aircraft is approaching the runway, an alert from “Traffic alerts for Pilots” can be triggered to make pilots stop the aircraft.
- **On runway,** according to the aircraft situation and considering that the aircraft has been cleared for entering this runway (and it is suitable):
 - In take-off position: if the airport is equipped, THLs will switch off if the runway is free from other traffic.

- In case of error, a traffic alert will be triggered if take-off is engaged so as to stop take-off. This alert will be consistent with red lights ON if take-off is initiated and another aircraft enters the runway so as to stop take-off.
- **On final approach/landing**, the same principles can be applied.

Summary: Conformance Monitoring and Traffic Alerts could come up at the same time when on taxiways only. However, a priority rule can be proposed, giving higher priority to traffic alerts.

During runway operations, when traffic alerts and RWSL are both present, they remain consistent i.e. if pilots are looking inside or out the window, they can see a message and listen to an audio or see red lights. All of them have complementary meanings. So, there is no sensorial confusion.

5.2.4.3 Benefits

Benefits of each function are complementary and cover situations from the gate to the runway (and vice-versa).

The on-board alerts allow covering different types of airport, from highly equipped ones with ground infrastructure (e.g. RWSL, A-SMGCS RIMS) to less equipped ones where aircraft functions can be used especially as safety nets.

RWSL will complement the on-board traffic alerts on runway as:

- RWSL will take account of vehicles.
- RWSL will take account primary surveillance data (non-cooperative primary target).

It might allow an optimization of means shared between ground and on-board segments i.e. efficient ground visual means to avoid runway incursions completed by a “traffic alert” safety net.

5.2.4.4 Constraints and limitations

The constraints and limitations are associated with the specific functions as mentioned in detailed descriptions from sections 5.2.2 and 5.2.3.

5.2.4.5 Assumptions

Assumptions are associated with the specific functions as mentioned in detailed descriptions from sections 5.2.2 and 5.2.3.

5.2.4.6 Problems and risks identified

As said above, traffic alerts and conformance monitoring alerts may coexist on taxiways and they are exclusive once engaged on a runway.

Nevertheless, to mitigate the risk of having compatibility alerts overlaying traffic alerts, a priority rule can be proposed to give higher priority to traffic alerts.

Traffic alerts for pilots and RWSL are complementary. RWSL works first to stop the aircraft if the runway is not vacant. Then, if the aircraft moves ahead, the traffic alert is triggered. Nevertheless, even if traffic alerts and RWSL are triggered at the same time or in a different order then they will remain consistent from the pilots' viewpoint, inside and outside the cockpit.

5.3 Tools for vehicle drivers

Both Runway Status Lights (RWSL) as well as a Vehicle Display System (VDS) may be in place as safety support tools for vehicle drivers. Although Take-off Hold Lights (THLs) will not be triggered for vehicles, RWSL generally behave the same as for aircraft. A VDS, however, is specifically designed for the needs of the vehicle driver. Besides showing the vehicle's own position on an airport moving map, it shall also display other traffic for situational awareness of all mobiles.

Since some vehicles already have a mobile device on board (e.g. laptop or tablet), the VDS may also run as an application on it since space in the car may not allow for another installation. It can be shown in the foreground when there is any alert or when the driver wants to see the application (e.g. for orientation or to identify a specific mobile).

For the up-link of alerts the vehicle must be able to receive P2P (Peer-To-Peer) messages. Since certain areas may become unavailable while the vehicle is driving on the manoeuvring area, the VDS needs to be able to receive map updates via data link.

The goal is that all vehicles using the manoeuvring area are equipped with a VDS.

To allow for different parameters depending on the type of vehicle operations (e.g. marshaller, snow cleaning, other service vehicle), the respective profile should be selected when starting up the application.

5.3.1 Runway Status Lights (RWSL)

For RELs, see section 5.2.1.

THLs service is not delivered to a mobile associated to an A-SMGCS track identified as a "Vehicle" so it means THLs will not be switched on in front of such mobile when driving on the runway.

Conversely a vehicle will be able to trigger a THLs switch on for THLs segments located in front of an aircraft lined up on the runway. Besides, a vehicle will be able to switch on RELs when driving on the runway.

5.3.2 Traffic alerts for vehicle drivers

5.3.2.1 General description and inputs

The proposed improvement is to increase safety between vehicles and aircraft on the manoeuvring area. The improvement is not to replace existing rules and procedures but to complement and provide an extra layer of safety to prevent accidents to occur.

Two types of implementations are foreseen in the project, depending on local existing systems:

- an alert directly generated on-board the vehicle; and
- an alert generated on-board the vehicle that has been processed via a ground server before reaching the vehicle. The time for that alert to reach the vehicle will be studied.

Alerts are generated within the manoeuvring area. Vehicle position and parameters for speed and heading will determine when caution and warning shall be triggered.

- Caution alert = Advisory to vehicles about a situation that is becoming potentially dangerous, providing information to help the vehicle driver to understand the reason for the danger. This

founding members



Avenue de Cortenbergh 100 | B -1000 Bruxelles
www.sesarju.eu

61 of 88

will be indicated by aural/visual alert and e.g. by highlighting the runway and involved aircraft on the moving map. The vehicle driver shall consider to take action that prevents the situation to develop into a dangerous situation and hence a warning alert.

- Warning alert = Alert generated to vehicles about an imminent danger situation. This will be indicated by aural/visual alert and e.g. by highlighting the runway and involved aircraft on the moving map. The vehicle driver shall take immediate action to avoid an accident, i.e. to drive out onto the grass.

The manoeuvring area is split in three virtual zones, runway zone, taxiway zone, for collision detection and a buffer zone in connection with the runway zone. The buffer zone is there to increase situational awareness for the vehicle drivers. The picture below gives an example of how the virtual zones could be described.

Normally a vehicle driver always gives way to an aircraft (if not instructed otherwise). If a risk of collision situation on a taxiway occurs, the vehicle driver will receive an alert (caution or warning depending on the situation). Algorithms for this will be developed and described in the OSED. Those algorithms will give the vehicle driver if positioned on the runway a “caution” and/or a “warning” when e.g. an aircraft is on final approach or starting take-off roll. This applies when a risk of collision occurs.

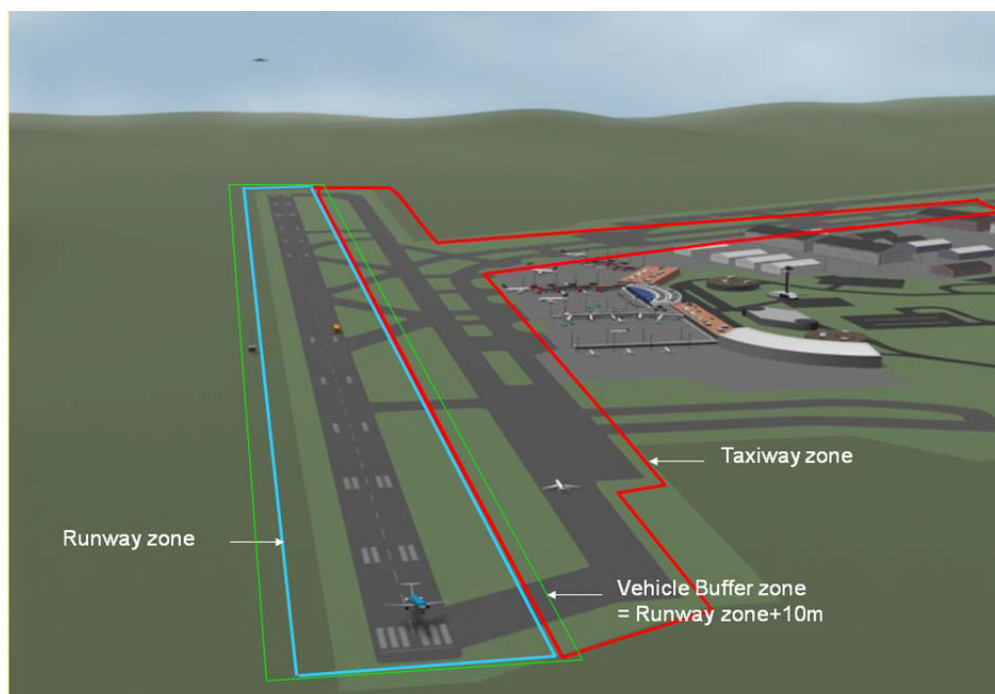

Figure 15 – Zones for traffic alerts for vehicle drivers

5.3.2.2 Functional architecture

There shall be an on-board vehicle display (not necessarily a separate unit and it may also run on a laptop) with a moving map showing own position and surrounding traffic linked to a module capable of triggering alerts when certain parameters/algorithms are exceeded. There will be two ways of alerting: one direct on-board the vehicle and one uplinked from the ground centralized server, as illustrated in the following figures.

Note: These figures provide the functional architecture for the two types of alerts for vehicle drivers, i.e. traffic alerts and area infringement alerts.

founding members



Avenue de Cortenbergh 100 | B -1000 Bruxelles
www.sesarju.eu

62 of 88

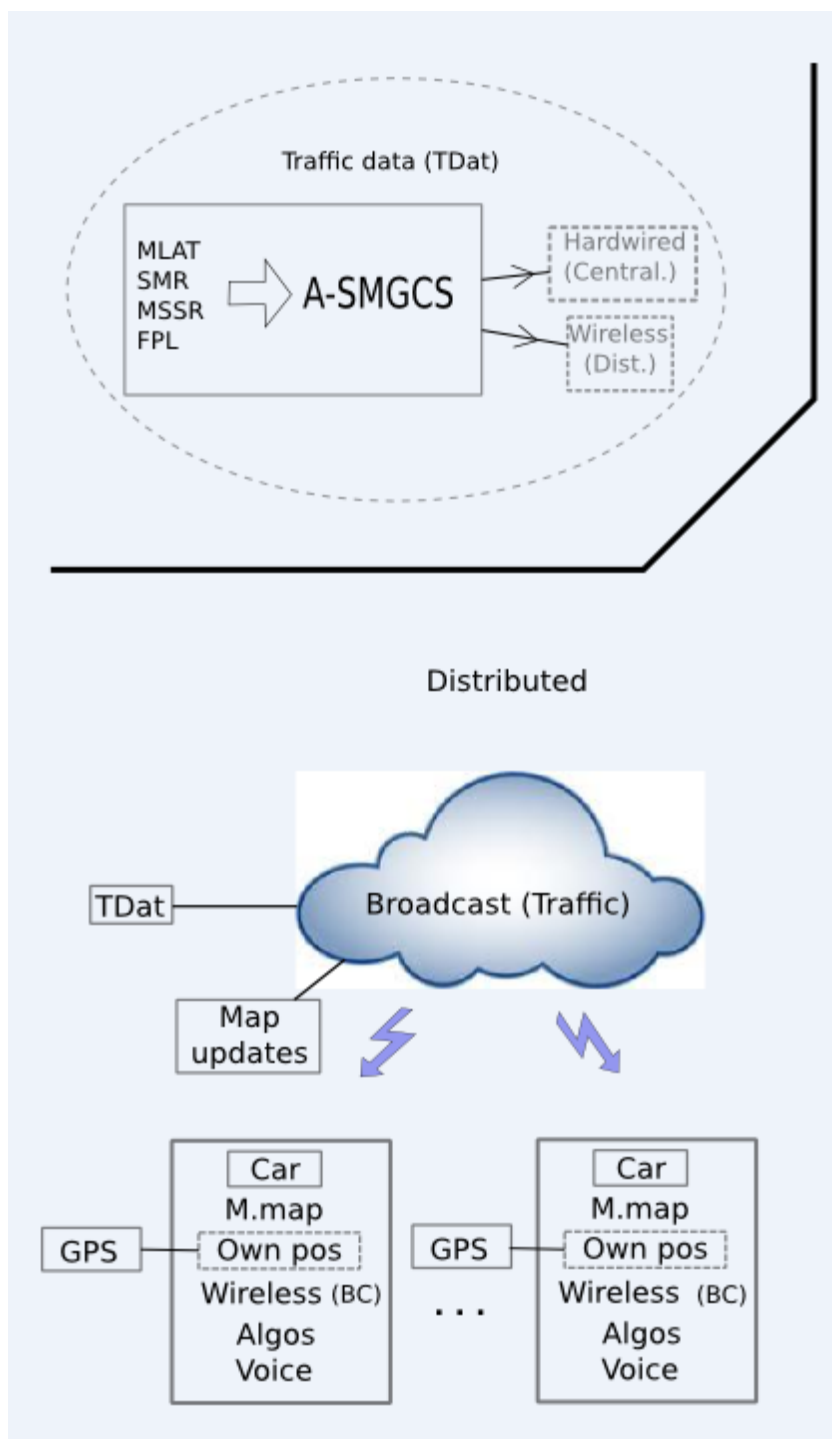

Figure 16 – Functional architecture for alerts directly generated on-board the vehicle

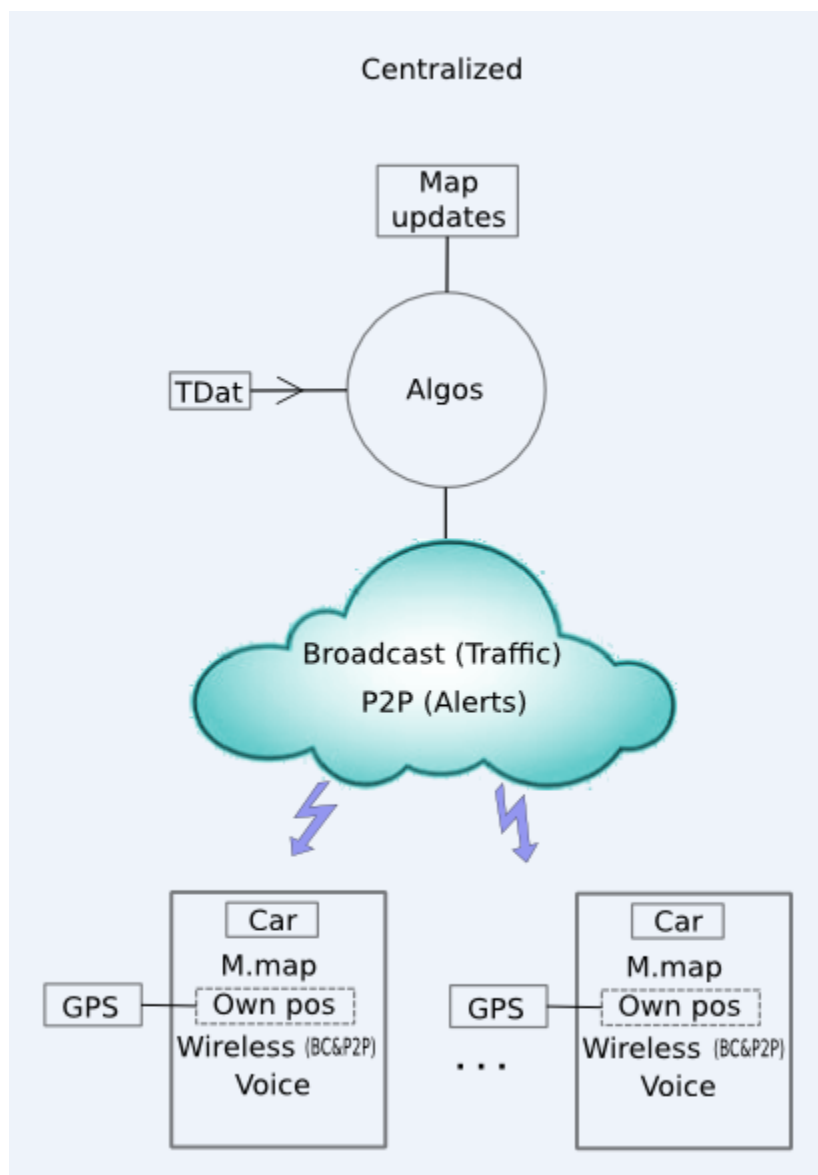

Figure 17 – Functional architecture for alerts uplinked to the vehicle

5.3.2.3 Benefits

In all weather conditions, vehicle drivers will have better situational awareness and be alerted if traffic conflict will appear on the manoeuvring area. An alert presented to the vehicle driver gives him the chance to take action to avoid a hazardous situation possibly quicker than if the alert has to pass through the controller. The controller involvement will not be necessary if algorithms are properly set.

5.3.2.4 Technological enablers

The following technological enablers are needed for both the on-board generated and uplink of alerts:

- A-SMGCS surveillance data (e.g. SMR, MLAT input, ADS-B)
- Sensor Data Fusion (SDF)
- Other traffic may also be received by the VDS via ADS-B IN

founding members



Avenue de Cortenbergh 100 | B -1000 Bruxelles
www.sesarju.eu

- Alert Modules, e.g. aural and visual,
- Moving map with ownship position presented
- TIS-B servers on ground
- Wireless system: broadcast and P2P

5.3.2.5 Constraints and limitations

TIS-B supports the broadcast of surveillance data obtained from other sources than ADS-B. Failure of TIS-B to meet relevant performance requirements might severely reduce the usefulness of the services. ADS-B out in aircraft could reduce the effect of a TIS-B failure.

The capacity of the wireless system is dependent of: e.g.

- amount of traffic data sent
- delay in transmission of data (data being “fresh”)
- radio coverage

The setting of all algorithms should be carefully investigated so that the number of false alerts is kept to a minimum/accepted level.

5.3.2.6 Assumptions

No further specific assumptions were identified.

5.3.2.7 Problems and risks identified

The cost for introducing new equipment may reduce the willingness of airport authorities to invest.

Depending on local IT infrastructure strategy, additional communication equipment might be needed where space can be limited in a car and causing additional costs.

5.3.3 Area infringement alerts for vehicle drivers

5.3.3.1 General description and inputs

In all weather conditions, but especially in adverse weather conditions, vehicle drivers may have difficulties in finding their way and to know their exact position on the manoeuvring area. To assist them when a potential infringement of closed area is imminent, an alert will be triggered.

A moving map will show own vehicle position. The moving map is considered to be a pre-requisite.

Closed areas and runways and possibly taxiways (where a clearance is required to enter the manoeuvring area from apron) are considered as restricted areas, where alerts will be triggered. All equipped vehicles operating on the manoeuvring area are subject to manage the alerting system.

Before entering a taxiway, the vehicle driver may need to ask ATC for a clearance. At some airports under specific weather conditions no clearance is needed for the vehicles to be on the taxiways.

Information about closed/restricted areas on the manoeuvring area could be generated for instance by D-NOTAM (WP08). The input of closed areas on taxiways is provided by the routing and planning function (P06.07.02/OFA04.02.01) to assure consistency with the respective planning system.

5.3.3.2 Functional architecture

There shall be an on-board vehicle display (not necessarily a separate unit and it may also run on a laptop) with a moving map showing own position and closed areas. It shall be linked to a module capable of triggering alerts when certain parameters/algorithms are exceeded. The moving map shall be automatically updated when there is new map information. There will be two ways of alerting: one direct on-board the vehicle and one uplinked from the ground centralized server, as illustrated in the figures in 5.3.2.2.

5.3.3.3 Benefits

The number of runway incursions caused by mobiles will be reduced. The risk of hazardous situations and collisions on the taxiways will be reduced.

5.3.3.4 Technological enablers

Technological enablers must be available both:

- Moving map including ownship position in vehicles;
- Alert modules e.g. aural and visual;
- Ability to receive a P2P message.

The moving map has to be updated with closed areas on the manoeuvring areas. Initially this will be done on a 28 day cycle (AIRAC) but also dynamically if within a shorter timeframe.

The system needs to be fed either manually or automatically, e.g. by D-NOTAM (WP08).

5.3.3.5 Constraints and limitations

The setting of all algorithms should be carefully investigated so that the number of false alerts is kept to a minimum/accepted level.

To avoid alerts where a driver is cleared to proceed on a restricted area, the alerting system needs to receive this information either via input on the VDS or as a clearance received via D/L from the respective controlling unit (Tower Ground or Runway Controller). In the latter case, the ATCO needs to be able to input the clearance for the vehicle on the HMI (via label of electronic flight strip).

5.3.3.6 Assumptions

No further specific assumptions were identified.

5.3.3.7 Problems and risks identified

The cost for introducing new equipment may reduce the willingness of airport authorities to invest.

Depending on local IT infrastructure strategy, additional communication equipment might be needed where space can be limited in a car and causing additional costs.

5.3.4 Integration of safety support tools for vehicle drivers

Today there is no alerting system towards aircraft for vehicle drivers operating on the manoeuvring area. Nor is there an alerting system for vehicles entering a closed area.

5.3.4.1 General description

RWSL and alerts for vehicles are both stand-alone systems working independently. Both systems are described in this OCD, ref. 5.3.2.1 and 5.3.3.1 (vehicle drivers) and 5.2.1 (RWSL).

5.3.4.2 Interactions

Not applicable.

5.3.4.3 Benefits

With both systems in operation, there will be an extra safety net to reduce the number of runway incursions.

5.3.4.4 Constraints and limitations

Not applicable.

5.3.4.5 Assumptions

The systems operate independently.

The RWSL and the defined runway zone should be positioned so no mismatching between alerts from the two systems occurs.

5.3.4.6 Problems and risks identified

Lack of performance of the airport surveillance system could lead to late, false and missed alerts.

5.4 Integration of safety support tools for flight crews/vehicle drivers and for controllers

The sections 5.1, 5.2 and 5.3 described the new safety support tools that are available to each type of airport users (controllers, flight crews and vehicle drivers respectively) and the integration of these safety support tools **from the perspective of each type of airport users** (sections 5.1.4, 5.2.4 and 5.3.4 respectively).

This section 5.4 addresses the issue of **coexistence of alerts provided to different types of airport users**, particularly between flight crews/vehicle drivers on one side and controllers on the other side.

5.4.1 General considerations

- **Terminologies for ground and airborne safety support tools should be consistent.** For instance, during the OCD Workshop on 20/01/2015, the term RPA was used for on-board traffic alerts. However, this RPA takes CAT I holding point as a reference of safety in terms of distance to the runway whatever the visibility conditions. It is not intended to monitor on-board the conformance with LVP procedures which remains part of ATCO role. This RPA is therefore not aligned with the RPA of the ground safety net for ATCOs (which is different for LVP and non-LVP conditions). The use of consistent terminologies will contribute to a common and shared understanding of the ground and airborne safety support tools by all developers.
- **Safety support tools use the same media as the common surveillance systems on the airport i.e. 1090 MHz.** In the case of unavailability of this media, the ground and airborne surveillance systems could be blind and the safety nets inoperative.
- **Algorithms and parameters for ground and airborne safety support tools are defined according to different criteria and using different inputs.** For example:
 - On-board traffic alerts are only triggered when a collision is predicted (taking account of trajectories, size of aircraft...) in order to minimize nuisance alerts. On ATC side, alerts are not only triggered when a collision is predicted (e.g. an A-SMGCS RIMS alert is triggered when there are two mobiles in the RPA).
 - The ground safety nets for ATC are designed and tuned to take into account the need to maintain the airport capacity. This tuning may not be possible for on-board safety nets. Moreover, the safety nets for ATC can use as input a consolidated surveillance information and operational status like current weather conditions.

5.4.2 Safety support tools for flight crews on taxiway

5.4.2.1 Interactions

The issue of coexistence of the safety support tools on taxiways for flight crews and for controllers is limited to the issue of coexistence of the on-board and ground conformance monitoring functions.

As said above, Conformance Monitoring alerts for pilots and for controllers work independently from each other. So, there is no coordination or synchronisation between them.

The actions associated with such an alert should be:

- If the alert is triggered in the tower, the controller will contact the flight crew to solve the operational issue,
- If the alert is triggered on-board, the flight crew will contact the tower to inform/confirm the error and ask for a new clearance.

However, it has to be noted that tools for controllers have a scope wider than tools for pilots:

- Tools for controllers take all clearances into account, which is not the case on the airborne side; and
- Tools for pilots have equivalent tools for controllers.

So, a preliminary analysis shows that:

- **At the gate:** If the on-board and ground-based tools are both available then they will first allow controllers to avoid sending erroneous instructions to pilots like using an inappropriate taxiway. For pilots, it will be mostly information to be displayed and checked independently as they already do it today. So, there should not be an alert triggered at the same time on both sides. Thus, there is no conflict between both tools.
- **During taxi:** Once initial checks have been done, tools prevent going to an inappropriate taxiway. For example, if a crew takes a wrong taxiway, an alert can appear on their display and it can also appear as a route deviation to controllers meaning that it leads to a shared view. The situation can be solved by R/T communication.

There is therefore a possibility to have alerts triggered on both sides if the aircraft and the airport are both equipped with the Conformance Monitoring tools. Consequently, one of them will contact the other party first. This should not lead to conflicts.

5.4.2.2 Benefits

The benefit of having Conformance Monitoring tools for aircraft and for ATC is to cover as many contexts as possible according to the level of airport and/or aircraft equipment.

5.4.2.3 Constraints and limitations

The constraints are linked to the level of equipment or tools available on both sides:

- For an on-board conformance monitoring function, the possibility to have data link communication between aircraft and controller,
- For a ground alert function, it relies on A-SMGCS airport surveillance availability and on the capability to input clearances into the system.

5.4.2.4 Assumptions

Data link is being deployed for purposes other than the mentioned alerts. So, a larger use of data link will be beneficial to the development of data link clearance and associated alerts.

5.4.2.5 Problems and risks identified

The problem could be the overlap when two alerts are triggered in the same timeframe on-board and on ground. So simultaneous actions to contact each other would be made by actors and generate confusion.

5.4.3 Safety support tools for flight crews on runway

5.4.3.1 Interactions

The issue of coexistence of the safety support tools on runways for flight crews and for controllers can be analysed through the coexistence of on-board traffic alerts with other tools for controllers. RWSL is indeed providing consistent alerts to flight crews as the on-board traffic alerts.

founding members



Avenue de Cortenbergh 100 | B -1000 Bruxelles
www.sesarju.eu

While traffic alerts will be generated for flight crews, some airports are (or will be) equipped with A-SMGCS RIMS, CATC and/or CMAC that will generate alerts for controllers to prevent any collision between aircraft and/or vehicles on runway. Therefore, in some situations, both systems can generate alerts to different actors, i.e. flight crews and controllers.

Both systems are designed independently as each of them can be operated in an environment where the other one is not available (i.e. aircraft not equipped with Traffic Alerts at airports equipped with A-SMGCS RIMS, and vice versa). Furthermore, there are different A-SMGCS RIMS implementations (e.g. different systems, different setting of a same system, etc.) and the surveillance sources can be different.

When approaching the runway:

- The CATC tool for controllers checks the respective clearances, so it should avoid providing conflicting clearances that would bring two aircraft (or one aircraft and one vehicle) at the same time on runway except for simultaneous taxiing.
- Then, by error, if one aircraft is moving to the runway without clearance, both the CMAC tool (and/or A-SMGCS RIMS) for controllers and the on-board traffic alert can be triggered at about the same time.

On runway or on approach: the behaviour of the tools is similar with the CATC tool for controllers checking and alerting the controllers immediately if contradictory clearances are given to different aircraft. If despite of this CATC tool, by error, an aircraft continues, the on-board traffic alert and the other ATC alerts (CMAC and/or A-SMGCS RIMS) will be triggered, leading to interrupt the operation (like reject take-off, go-around if on final approach).

Alerts on the runway for controllers and for pilots should therefore not be conflicting because they address the same concerns. If the crew has a red alert, the immediate crew action should be in-line with the one that could also be requested by the controller.

5.4.3.2 Benefits

The availability of Traffic alerts for flight crews will allow providing a safety support tool at airports not equipped with A-SMGCS RIMS, CATC and/or CMAC.

At equipped airports, it may contribute to save some time in informing directly the flight crews about the risk of collision.

A-SMGCS RIMS will complement the on-board traffic alerts on runway as:

- A-SMGCS RIMS will take account of vehicles.
- A-SMGCS RIMS will take account of aircraft in case of transponder failure (primary target).

5.4.3.3 Constraints and limitations

Not applicable.

5.4.3.4 Assumptions

Not applicable.

5.4.3.5 Problems and risks identified

The following potential issues have been identified:

- **The probability of simultaneous access to R/T may increase**

founding members



Avenue de Cortenbergh 100 | B -1000 Bruxelles
www.sesarju.eu

If the on-board and ground alerts are triggered at about the same time then the flight crews and ATCOs could access R/T at the same time. In that case, ATCO instructions to resolve the conflict could not be heard and/or could be delayed.

- **ATCOs may influence pilots' decision on conflict resolution**

If the pilots are alerted before the ATCO then the pilots will take decision on how to resolve the conflict. As the ATCO gets alerted, he could give instructions, which are in contradiction with pilots' decision.

- **Pilots may influence ATCO's decision on conflict resolution**

If the ATCO is alerted before the pilots then the ATCO will take decision on how to resolve the conflict (e.g. instruction to be given to first aircraft). As the second aircraft is alerted and contacts ATC to get instruction, attention of the ATCO may be brought towards the second instead of the first aircraft.

These potential issues should be addressed in integrated validations with both ground and airborne alerts.

In this context, the complementarity of CATC can be pointed out as CATC indications can prevent the triggering of other on-board and ground alerts, and therefore avoid any associated issues related to the coexistence of these alerts. The on-board indications i.e. Traffic Indication (TI) and Runway Status Indication (RSI) can also bring anticipation on a conflict.

5.4.4 Traffic alerts for vehicle drivers

The proposed improvement is to increase safety between vehicles and aircraft on the manoeuvring area.

Two different implementations are discussed in the project. An alert directly triggered on-board the vehicle and an alert triggered on-board the vehicle that has been processed via a ground centralized server before being uplinked to the vehicle.

5.4.4.1 Interactions

Traffic alerts for vehicle drivers can be triggered when the vehicle is on the entire manoeuvring area. These alerts are therefore not limited to the runway area as it is the case for the traffic alert systems for flight crews and for controllers (A-SMGCS RIMS). The traffic alerts for vehicle drivers will therefore complement the other traffic alert systems when the vehicle is on the manoeuvring area but not in the runway area.

When the vehicle is in the runway area, both the flight crew and the controller can be alerted too and take action to follow predefined procedures in order to avoid the conflict. Even if the alerting systems are using similar algorithms, alerts are expected to be generated at different times because they will be using different sets of parameters for different operating roles.

5.4.4.2 Benefits

With independent systems for ATC and Vehicle drivers, alerts could still be generated if one system fails. For instance, if the ATC alerting system fails, the vehicle system will continue to work and vice versa, assuming that the surveillance systems are operative.

5.4.4.3 Constraints and limitations

In Step 1, vehicle traffic is not taken into account on-board aircraft.

If certain vehicles operating on the manoeuvring area are not properly identified (e.g. via ADS-B or TIS-B), aircraft and ATC may not fully be capable to detect and prevent hazards resulting from deviations and errors.

5.4.4.4 Assumptions

In order to achieve the full safety benefits, all vehicles and aircraft moving on the manoeuvring area should be properly identified.

5.4.4.5 Problems and risks identified

The setting of all algorithms should be carefully investigated so that the number of false alerts is kept to a minimum/accepted level.

The HMI should be usable. The procedures should be simple and harmonised together with an acceptable workload.

5.4.5 Area infringement alerts for vehicle drivers

5.4.5.1 Interactions

Before infringement of a restricted or closed area the vehicle driver will receive an alert and thus can take action to avoid the area. The vehicle driver can receive two levels of alerts, caution and warning.

ATC should, in order to minimize the number of alerts, only receive a warning if an infringement is about to take place.

Alert parameters can be set at different levels depending on the areas.

5.4.5.2 Benefits

Vehicle drivers will always have an alert if they have not updated the system accordingly after having received a clearance. The risk of entering an area without permission is minimised.

5.4.5.3 Constraints and limitations

The setting of all algorithms should be carefully investigated so that the number of false alerts is kept to a minimum/accepted level.

5.4.5.4 Assumptions

Not applicable.

5.4.5.5 Problems and risks identified

Updating restricted areas on the moving map manually may be forgotten. Therefore, an automatic update may reduce this risk and allow coherence on all moving maps (requiring coordination with WP08).

6 Operational examples

The purpose of this section is to illustrate the operation of the new safety support tools described in section 4, using operational examples. It is an opportunity to describe the interactions between all the safety support tools provided in the airport environment.

6.1 Runway incursions

6.1.1 Example 1.1: Aircraft cleared to take-off and aircraft crossing runway

6.1.1.1 Operational description

A/C2 lands on runway 08R. Then, ATC instructs A/C2 to hold at holding point before runway 08L. Nevertheless, A/C2 goes through the holding point S7 and partially enters runway 08L while A/C1 is rolling for take-off.

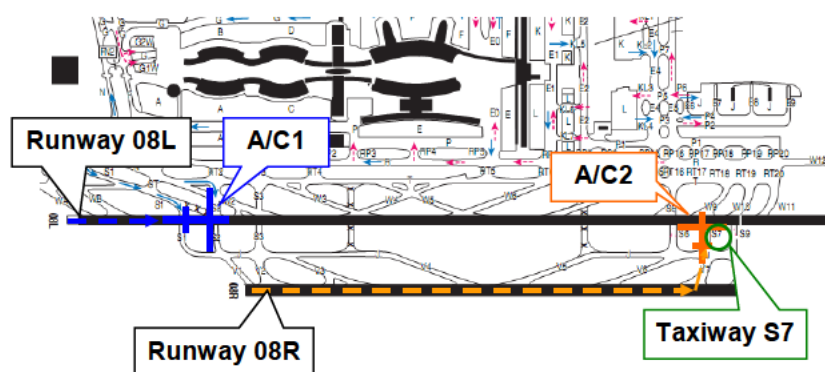

6.1.1.2 Available safety support tools

The safety support tools considered in this example are:

- Traffic alerts for Flight crews;
- Currently operational runway incursion alerting system for controllers (A-SMGCS RIMS);
- Conflicting ATC clearances detection;
- Conformance monitoring for controllers;
- Currently available visual aids at RWY entry.

6.1.1.3 Sequence of events

View from A/C1 that is equipped with “Traffic Alerts”

As the A/C1 crew was cleared to take off, they are confident that the runway is clear from traffic. If A/C1 Navigation Display is set on the “Arc” Mode ground traffic is not displayed. As A/C2 is moving from the stop bar towards the runway, an indication appears to the A/C1 flight crew who:

- focus their attention on the runway, and
- one of the pilots looks at traffic display to identify the cause.

As they monitor the situation i.e. what A/C2 is doing:

- the A/C1 flight crew may decide to go on taking off if it estimates that A/C2 has crossed and is vacating the runway, or
- a warning is triggered because A/C2 stopped too late and too close to the runway and A/C1 crew decides to stop.

A-SMGCS RIMS triggers an alert for the controller. He can therefore immediately give instructions to A/C1 and/or A/C2 to solve the conflict (e.g. instructs A/C2 to stop or A/C1 to abort take-off).

Conflicting ATC clearances detection (CATC) do not trigger any alert in this example as ATC clearances are not conflicting, but a CATC predictive indication may be shown to the controller to indicate that a Cross clearance for A/C2 would be conflicting with the Take-off clearance. A conformance monitoring alert is triggered because A/C2 is not stopping at the holding point and it is followed by an A-SMGCS RIMS alert.

Notes:

- *At airports using runway stop bars in all weather conditions, the probability of such situations is already reduced but still happening.*
- *At airports using runway stop bars in all weather conditions and where runway incursions are identified monitoring crossings of an active stop bar, a respective RIMS alert (e.g. "Stop bar crossed") will be triggered to the controller.*

6.1.1.4 Specific issues to consider

This example highlights some issues that should be investigated during the validation activities:

- Traffic alert for flight crews during take-off run
- Partial equipage (Traffic alert for flight crews)
- Clear operational procedures for controllers and flight crews – a proposal is to consider that when there is an on-board warning, priority is given to flight crew decision which should be here to reject take-off above communication with controller.
- See issues in section 5.4.3.5.

6.1.2 Example 1.2: Variation on example 1.1 with RWSL

6.1.2.1 Operational description

Same example (see 6.1.1.1).

6.1.2.2 Available safety support tools

The safety support tools considered in this example are:

- Traffic alerts for flight crews;
- Currently operational runway incursion alerting system for controllers (A-SMGCS RIMS);
- Conflicting ATC Clearances detection;
- Currently available visual aids at runway entry;
- RWSL.

6.1.2.3 Sequence of events

RELs are ON for A/C2 when A/C1 has a certain speed and give the information to the A/C2 flight crew that the runway is unsafe to enter. This would have prevented A/C2 to enter the runway.

No A-SMGCS RIMS and no Traffic alerts for pilots would be triggered unless A/C2 enters the RWY. THLs will be ON for A/C1 when it has a certain speed and A/C2 is in the THLs Safety Region.

6.1.2.4 Specific issues to consider

This example highlights some issues that should be investigated during the validation activities:

- Several AGL elements (stop bar, RELs & maybe taxiway centre line lights) combined

6.1.3 Example 2: Line-up without clearance with landing aircraft

6.1.3.1 Operational description

A/C2 is on short final. A/C1 passes by the holding point and moves toward the same runway.

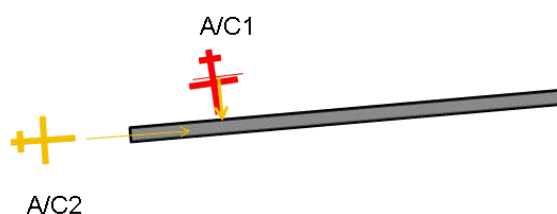

6.1.3.2 Available safety support tools

The safety support tools considered in this example are:

- Traffic alerts for flight crews;
- Currently operational runway incursion alerting system for controllers (A-SMGCS RIMS);
- Conformance monitoring for controllers;
- Currently available visual aids at runway entry.

6.1.3.3 Sequence of events

View from A/C1 that is equipped with "Traffic Alerts"

As A/C2 crew was cleared to land, they are confident that the runway is clear from traffic. As A/C2 is approaching the runway, A/C1 is moving from the stop bar without being cleared. An alert appears to the A/C1 flight crew who:

- focus their attention on the runway, and by extension to traffic,
- the flight crew looks at traffic display to identify the cause and detect the aircraft,
- the flight crew decides to stop and contacts ATC.

ATC also got an alert from Conformance Monitoring which detected that the aircraft should not be there as it has not received a clearance and calls A/C1 and/or A/C2 to solve the conflict.

Notes:

- *At airports using runway stop bars in all weather conditions, the probability of such situations is already reduced but still happening.*
- *In airports equipped with RWSL, this safety tool should reduce these situations by providing the runway status about aircraft on the runway that pilots can also detect on their moving map.*
- *In airports not equipped with RWSL, the Runway Status Indications triggered on-board have the same objective by informing the flight crew that the runway is already occupied by another aircraft.*
- *In section 6.4.1, a similar scenario is presented with A/C1 that has also being cleared and the conflicting ATC clearances function being active.*

6.1.3.4 Specific issues to consider

The issue raised here is to find a trade-off to trigger the on-board alert between:

- No alert when A/C1 has not reached the holding point (preferably CAT I) because it is a normal situation occurring for every flight,
- Get an alert as soon as it is passing the holding point to yield the possibility to stop staying at a sufficient distance from the runway pavement to keep some sufficient distance from an aircraft operating at a high speed on runway.

6.2 Incidents on taxiways

6.2.1 Example 1: Vehicle passes too close in front of aircraft

6.2.1.1 Operational description

Aircraft taxis on a taxiway or out of a stand onto a taxiway and crosses a service road where a vehicle crosses too close (less than 200 m?) in front of the aircraft.

Slight variation: A vehicle (who's allowed to drive on or across a taxiway) passes too close (less than 200 m?) in front of a taxiing aircraft.

6.2.1.2 Available safety support tools

The safety support tool considered in this example is:

- Traffic Alerts for vehicle drivers.

6.2.1.3 Sequence of events

If vehicle is equipped with an alerting system, an alert can be triggered if it comes too close to the aircraft trajectory.

6.2.1.4 Specific issues to consider

This example highlights some issues that should be investigated during the validation activities:

- Partial equipage (Traffic Alert for vehicle drivers): many cars (esp. those only using service roads) might not be equipped.
- "Low cost" alerting system?

6.2.2 Example 2: Closed area infringement

6.2.2.1 Operational description

A vehicle has a clearance on the manoeuvring area e.g. to make a runway inspection. His way to the runway passes through a closed area on the taxiway. ATC has failed to give a clearance avoiding the closed area. The vehicle driver, when approaching the closed area, receives an alert and can take action to avoid the area and ask for a new clearance from ATC.

6.2.2.2 Available safety support tools

The safety support tools considered in this example are:

- Traffic display including moving map,
- Alerts presented visual and/or aural.

6.2.2.3 Sequence of events

1. Vehicle driver requests clearance to from apron to the runway for a runway inspection

founding members



Avenue de Cortenbergh 100 | B -1000 Bruxelles
www.sesarju.eu

2. ATC gives clearance to drive from apron to the runway via taxiway.
3. Vehicle driver reads back clearance
4. Vehicle driver starts driving
5. When turning to an area on the taxiway that is temporarily closed he receives an alert and stops.
6. Vehicle driver requests a new clearance.

6.2.2.4 Specific issues to consider

- Alerting system must be updated with information about the position and range of the closed areas
- Clear operational procedures for controllers and vehicle drivers must be tested, established and trained.

6.3 Conflicting ATC clearances

6.3.1 Example 1: Aircraft cleared to line-up while another aircraft is already cleared for landing

6.3.1.1 Operational description

Traffic on the runway is managed by the Tower Runway Controller. The airport is equipped with a single runway used for Arrival and Departure. Meteorological conditions are bad, visibility is reduced but Low Visibility Operations are not in operation. This is the morning peak period and the Tower Runway Controller has a heavy workload. A/C1 is on final, has contacted the Tower Runway Controller and is on frequency. After initial contact, the Tower Runway Controller gives A/C1 its clearance for landing on the runway. Few minutes later, departing A/C2 contacts the Tower Runway Controller and is cleared to taxi until its holding point of the runway. When reaching the holding point, A/C2 reports its position. The Tower Runway Controller clears A/C2 for line-up, forgetting his/her previous landing clearance given to arriving A/C1.

6.3.1.2 Available safety support tools

The safety support tool considered in this example is:

- Conflicting Clearance detection tool.

6.3.1.3 Sequence of events

1. Arriving A/C1 contacts the Tower Runway Controller and is under his/her control
2. Tower Runway Controller gives A/C1 the Landing Clearance and inputs the clearance in the system via the HMI
3. Departing A/C2 contacts the Tower Runway Controller and is under his/her control
4. A/C2 is cleared to taxi to the runway holding point
5. A/C2 reports its position at the holding point
6. Tower Runway Controller clears A/C2 for line-up and inputs the clearance in the system via the HMI, leading to one of the following cases or both depending on CATC implementation:
 - A predictive CATC indication is displayed to the ATCO before the line-up clearance is input into the system.
 - As soon as the line-up clearance is input, the Conflicting Clearance server detects the inconsistent clearances and an alert message is displayed (e.g. "Conflict LAND/LINE-UP A/C1-A/C2") on the controller HMI for immediate corrective action.

6.3.1.4 Specific issues to consider

None

6.3.2 Example 2: Aircraft cleared to take-off while vehicle is on the runway

6.3.2.1 Operational description

Traffic on the runway is managed by the Tower Runway Controller. The airport is equipped with a single runway used for Arrival and Departure. Meteorological conditions are normal. The situation occurs at midday when the traffic is very low and controllers do not have a heavy workload. An inspection vehicle is on the Tower Runway Controller frequency and has been cleared to enter the runway to perform a runway inspection at one end of the runway. At the other end of the runway, flight A/C1, on the Tower Runway Controller frequency has been cleared to line-up. When line-up is complete, the controller gives the aircraft its take-off clearance forgetting that a mobile is still on the runway.

6.3.2.2 Available safety support tools

The safety support tool considered in this example is:

- Conflicting Clearance detection tool.

6.3.2.3 Sequence of events

1. Inspection vehicle FLYCO1 is on the Tower Runway Controller frequency. The controller clears the mobile to enter the runway by voice and makes the associated input via its HMI
2. The vehicle enters the runway
3. The flight A/C1 is under runway control. The controller clears the aircraft to line-up by voice and makes the associated input via its HMI
4. The flight A/C1 enters the runway and completes its line-up procedure
5. The Tower Runway Controller then clears the aircraft to take-off and makes the associated input via its HMI, leading to one of the following cases or both depending on implementation:
 - A predictive CATC indication is displayed to the ATCO before the take-off clearance is input into the system.
 - As soon as the Take-Off clearance is input, the Conflicting Clearance server detects the conflicting ATC clearances and an alert message (e.g. "Conflict ENTER/ TAKE-OFF FLYCO1-A/C1") is displayed on the controller HMI for immediate corrective action.

6.3.2.4 Specific issues to consider

None

6.3.3 Example 3: Aircraft cleared to land while vehicle is on the runway

6.3.3.1 Operational description

A vehicle is given clearance to enter the runway area (e.g. to perform maintenance). While still within the runway area, an aircraft is on approach to that runway and given landing clearance by the ATCO.

founding members



Avenue de Cortenbergh 100 | B -1000 Bruxelles
www.sesarju.eu

81 of 88

6.3.3.2 Available safety support tools

The safety support tools considered in this example are:

- Currently operational runway incursion alerting system for controllers (A-SMGCS RIMS);
- Traffic alerts for vehicle drivers;
- Traffic alerts for Flight crews;
- Conflicting ATC clearances detection (CATC);

6.3.3.3 Sequence of events

Depending on the implementation of CATC:

- A preventive indication is displayed to the ATCO, to show him that the landing clearance, if selected, would be in conflict with another clearance.
- When the landing clearance is input, the ATCO receives a CATC alert indicating the (future) conflict between the vehicle on the runway and the aircraft on approach.

As the aircraft is in final approach, both the ATCO and the vehicle driver will be alerted with a Stage 1 alert (RIMS for the ATCO and Traffic alert for the vehicle driver). If no action is taken to resolve the conflict, a Stage 2 alert will be triggered for the ATCO as well as for the vehicle driver.

Depending on the exact circumstances (e.g. type of vehicle involved) and reaction time by the vehicle driver to check the alert (e.g. if outside the vehicle), the ATCO might request the vehicle driver to immediately vacate the runway or command the flight crew to go around.

At this point, if vehicles on the runway are taken into account by the on-board traffic alerting system, the flight crew will receive a respective alert. As they monitor the situation the flight crew may decide to continue landing or go around.

6.3.3.4 Specific issues to consider

This example highlights some issues that should be investigated during the validation activities:

- Tuning of the different alerts (i.e. who receives which alert and when?) seems of utmost importance.
- Traffic alert for flight crews on short final or only up to the minimum descent altitude/decision altitude?

6.4 Non-conformance to ATC clearances

The first example describes a “Non-conformance to ATC clearances” detected by the ATC System on Ground with alert provided to the controller.

The second example describes a “Non-conformance to ATC clearances” detected by the On-Board System with alert provided to the flight crew.

6.4.1 Example 1: “Taxi without clearance”

6.4.1.1 Operational description

Departing traffic is handled by the Tower Ground Controller on the airport. A departing A/C1 is on the Tower Ground Controller frequency. The Tower Ground Controller has just cleared A/C1 for Push-Back and inputs at the same time the clearance in the system via the HMI. Once pushed and ready to taxi, the aircraft starts to move without instruction. The A-SMGCS is showing the aircraft is moving. The system checks the last clearance given to A/C1 and detects that no clearance has been given for that flight and triggers an alert message to the Tower Ground Controller HMI.

There is no equivalent function on-board.

6.4.1.2 Available safety support tools

The safety support tool considered in this example is:

- Conformance Monitoring tool for controllers

6.4.1.3 Sequence of events

1. A/C1 is on Tower Ground Controller Frequency
2. The Tower Ground Controller clears A/C1 for Push-Back and input the clearance in the system
3. Once Pushed and ready for taxi, A/C1 starts to move without clearance
4. The System uses the A-SMGCS Surveillance data to detect the movement of the aircraft and checks the last clearance given by the Tower Ground Controller
5. The system detects the problem and alerts the Tower Ground Controller by displaying an alert message on the controller HMI

6.4.1.4 Specific issues to consider

None

6.4.2 Example 2: Route deviation

6.4.2.1 Operational description

This tool may exist on controller and flight crew side.

For flight crews, the conformance monitoring tool for flight crews relies on the uplinked route and clearance.

founding members



Avenue de Cortenbergh 100 | B -1000 Bruxelles
www.sesarju.eu

The aircraft has received the routing towards the runway. During the taxi phase, the aircraft deviates from the cleared route. In order to provoke this situation, several factors are needed to create a workload sufficient to attract both flight crews' attention towards other actions such as:

- Looking outside to check the actual taxiway indications and other traffic;
- Reduced visibility;
- Radio communication;
- Changes requested by the controller.

6.4.2.2 Available safety support tools

The safety support tool considered in this example is:

- Conformance monitoring tool for flight crews
- Conformance monitoring tools for controllers

6.4.2.3 Sequence of events

The controller initiates the route and sends it to the aircraft by data link.

The flight crew asks for the push-back clearance.

The controller gives the clearance for push-back to the flight crew.

After push-back, the flight crew receives the taxi clearance and route.

The flight crew starts taxiing.

- Events contributing in crew distraction

The flight crew misses to turn as indicated.

On-board:

Conformance monitoring tool for flight crews triggers an alert.

The flight crew stops and watches the map (moving map or airport chart).

The flight crew informs ATC.

On ground:

Conformance monitoring tool for controllers detects the deviation and triggers an alert.

The controller contacts the flight crew.

6.4.2.4 Specific issues to consider

The issue is to perform a timely detection to minimize impact for the aircraft to resume its route to the runway (rather next holding point).

6.4.3 Example 3: Non-conformance to taxiway suitability

6.4.3.1 Operational description

For flight crews, the conformance monitoring tool relies on the uplinked route and clearance.

The aircraft has received the routing towards the runway. During the taxi phase, the aircraft deviates from the taxi route and turns toward an unsuitable taxiway. Factors causing this action can be:

- High workload,
- Reduced visibility

6.4.3.2 Available safety support tools

The safety support tools considered in this example are:

- Conformance monitoring tool for flight crews
- Conformance monitoring tools for controllers

6.4.3.3 Sequence of events

After receiving the taxi route and associated clearance, the flight crew starts taxiing.

- Events contributing in crew distraction

The flight crew turns too early towards a taxiway unsuitable to aircraft of that size.

On-board:

Conformance monitoring tool for flight crews triggers an alert.

The flight crew stops and watches the map (moving map or airport chart).

The flight crew informs ATC to ask about the possible action e.g. be allowed to continue, be pushed back towards the taxiway

On ground:

Conformance monitoring tool for controllers detects the deviation and triggers an alert.

The controller calls the flight crew for an appropriate action.

6.4.3.4 Specific issues to consider

The issue is to perform a timely detection to minimize impact on aircraft and on airport traffic activity to be able to perform a quick corrective action.

7 References

7.1 Applicable Documents

- [1] Template Toolbox 03.00.00
<https://extranet.sesarju.eu/Programme%20Library/SESAR%20Template%20Toolbox.dot>
- [2] Requirements and V&V Guidelines 03.00.00
<https://extranet.sesarju.eu/Programme%20Library/Requirements%20and%20VV%20Guidelines.doc>
- [3] Templates and Toolbox User Manual 03.00.00
<https://extranet.sesarju.eu/Programme%20Library/Templates%20and%20Toolbox%20User%20Manual.doc>
- [4] EUROCONTROL ATM Lexicon
<https://extranet.eurocontrol.int/http://atmlexicon.eurocontrol.int/en/index.php/SESARdate>
- [5] P06.02 D100 Airport Step 1 DOD 2013 update 00.01.01 07/03/2014
- [6] P06.02 D101 Airport Step 2 DOD 2014 Update 00.01.00 16/01/2015
- [7] B4.2 D66 SESAR CONOPS Step 1 Edition 2013 v02.00.00 09/05/2014

7.2 Main P06.07.01 deliverables

This section lists the most recent and relevant P06.07.01 OSED, SPR and Validation Reports.

7.2.1 RWSL

- [8] "RWSL OSED to support V3 trials", D07, v00.01.03, 19/03/2012

7.2.2 Alerts for controllers

- [9] "Interim (Final) OSED for Conflicting ATC Clearances and Conformance Monitoring for Controllers", D32, v00.00.04, 01/09/2014
- [10] "SPR for Conflicting ATC Clearances and Conformance Monitoring for Controllers", D29, v00.01.01, 21/11/2014

7.2.3 Conformance monitoring alerts for flight crews

- [11] "Updated OSED Conformance Monitoring for Pilots", contribution to P09.14 D03 FRD, v00.00.03, 29/07/2013
- [12] "Updated SPR Conformance Monitoring for Pilots", contribution to P09.14 D03 FRD, v00.00.03, 13/01/2014

7.2.4 Alerts for vehicle drivers

- [13] "V2 Validation Report for "Alerts for vehicle drivers", D38, v00.01.03, 11/06/2012

founding members



Avenue de Cortenbergh 100 | B -1000 Bruxelles
www.sesarju.eu

86 of 88

- [14] "Updated OSED for "Alerts for vehicle drivers" following V2 trials", D39, v00.01.02, 20/07/2012

7.2.5 Traffic alerts for flight crews

- [15] "Updated OSED for traffic alerts for pilots following V2 trials", contribution to P09.14 D03 FRD, v00.01.00, 14/11/2013
- [16] "Updated SPR for Traffic Alerts for Pilots", contribution to P09.14 D03 FRD, v00.01.00, 20/12/2013

7.3 Other documents

- [17] EUROCONTROL "Operational Concept and Requirements for A-SMGCS Implementation Level 2", Ed. 2.1, 30/06/2010
- [18] ETSI EN 303 213-2 "Advanced Surface Movement Guidance and Control System (A-SMGCS); Part 2: Community Specification for application under the Single European Sky Interoperability Regulation EC 552/2004 for A-SMGCS Level 2 including external interfaces", V. 1.1.1, 15/10/2010
- [19] EUROCONTROL "European Action Plan for the Prevention of Runway Incursions" Edition 2.0 April 2011
- [20] RTCA DO-323, "Safety, Performance And Interoperability Requirements Document For Enhanced Traffic Situational Awareness On The Airport Surface With Indications And Alerts (SURF IA)", December 2010
- [21] "Aerodromes", ICAO, Annex 14 to the Convention on International Civil Aviation, Volume I, Fifth edition, 5 July 2009
- [22] "Air Traffic Management," ICAO, Procedures for Air Navigation Services, Document 4444, Fifteenth edition, Amendment 3, 18 November 2010
- [23] "Rules of the Air", ICAO Annex 2, 10th Edition, Amendment No. 39, 23 November 2006
- [24] CS 25.1322 "Flight Crew Alerting", EASA
- [25] EVAIR Safety Bulletin N°11 2008-2012, EUROCONTROL, February 2014
- [26] COMMISSION REGULATION (EU) No 139/2014, 12 February 2014
- [27] Decision 2014/012/R of the Executive Director of EASA and its annex, 27 February 2014

-END OF DOCUMENT-

