

SESAR 2020 PJ.10-W2-93A Final TS/IRS TRL6 (and 93B, 93C TRL4)

Deliverable ID:	D3.2.060
Dissemination Level:	PU
Project Acronym:	PJ.10-W2-PROSA
Grant:	874464
Call:	H2020-SESAR-2019-1
Topic:	Separation Management and Controller Tools
Consortium Coordinator:	DFS
Edition Date:	May 15, 2023
Edition:	00.01.01
Template Edition:	02.00.06

Founding Members



Authoring & Approval

Authors of the document

Beneficiary	Date
DSNA	12/12/2022
ENAV	12/12/2022
DFS	12/12/2022
EUROCONTROL	12/12/2022
INDRA	12/12/2022
LEONARDO	12/12/2022
NATS	12/12/2022

Reviewers internal to the project

Beneficiary	Date
DSNA	20/12/2022
ENAV	24/12/2022
DFS	24/12/2022
INDRA	24/12/2022
LEONARDO	24/12/2022
NATS	24/12/2022

Reviewers external to the project

Beneficiary	Date

Approved for submission to the S3JU By - Representatives of all beneficiaries involved in the project

Beneficiary	Date
COOPANS	09/02/2023
DSNA	12/02/2023
DFS	09/02/2023
ENAV	10/02/2023

EUROCONTROL	09/02/2023
FREQUENTIS	13/02/2023
INDRA	09/02/2023
LEONARDO	20/01/2023
NATS	13/02/2023
PANSA	13/02/2023
SKYGUIDE	09/02/2023
THALES	13/02/2023

Rejected By - Representatives of beneficiaries involved in the project

Beneficiary	Date

Document History

Edition	Date	Status	Beneficiary	Justification
00.00.01	12 Dec 22	Draft	PY Gauthier	Initial version for review
00.01.00	13 Feb 23	Final	PY Gauthier	Final for approval
00.01.01	15 May 23	Final	PY Gauthier	POIs/ENs Update after Gate Review

Copyright Statement © 2023 – ENAV, INDRA, NATS, DGAC/DSNA, DFS, Eurocontrol, Skyguide, Frequentis, ENAV, Leonardo, ENAIRE, PANSA, THALES AIR SYS, NAVIAIR/COOPANS. All rights reserved. Licensed to SESAR3 Joint Undertaking under conditions.

PJ.10-W2-PROSA

PJ.10-W2-93 DELEGATION OF ATM SERVICES PROVISION AMONG ATSUS

This Technical Specification is part of a project that has received funding from the SESAR Joint Undertaking under grant agreement No 874464 under European Union's Horizon 2020 research and innovation programme.



Abstract

The objective of the SESAR Solution PJ.10-W2-Solution 93 is to explore the different possible cases of delegation of provision of ATM Services amongst ATSUs based on traffic / organisation needs (either static on fix-time transfer schedule (Day/Night) or dynamic, e.g. when the traffic density is below/over certain level) or on contingency needs.

The delegation operational concept can be supported by three different architectures, aka “Y”, “D” and “U”. Each of them has been developed in a specific technological solution and referenced as SESAR PJ.10-W2 Technological Solutions 93A, 93B and 93C. In the scope of PJ.10-W2-Solution 93, only Solution 93A is planned to reach TRL6 and be officially proposed for supporting PJ.10-W2-Solution 93 to reach V3. However, this document gathers the technical elements developed for the three Technological Solutions 93A, 93B and 93C, maintaining a clear separation between the common architecture parts and the specific ones. Each of these Technological Solutions is corresponding to a particular Virtual Centre architecture as proposed in the taxonomy issued by the EUROCAE WG122.

For each of these architectures, this document provides the technical specifications needed to implement the delegation use cases developed by the Operational Thread of the SESAR Solution PJ.10-W2-93. It also defines the Services that are expected to be implemented by ATM Data Service Providers for interacting with Virtual Centre Air Traffic Service Units, or between themselves in an interoperable manner.

The document also integrates a contribution from PJ.32-W3-02 which concerns general “Y” functional architecture requirements (i.e. not specific to delegation context) and the improvement of payloads of some Virtual Centre services.

Table of Contents

Abstract	4
1 Executive summary	10
2 Introduction	12
2.1 Purpose of the document.....	12
2.2 Scope	12
2.3 Intended readership	12
2.4 Background	13
2.5 Structure of the document.....	13
2.6 Glossary of terms.....	14
2.7 Acronyms and Terminology	16
3 SESAR Solution Impacts on Architecture	22
3.1 Target Solution Architecture	22
3.1.1 SESAR Solution(s) Overview	22
3.1.2 From Architecture Views to SESAR Solutions.....	22
3.1.3 Architectures Details	24
3.1.3.1 Deviations with respect to the SESAR Solution(s) definition.....	32
3.1.3.2 Relevant Use Cases.....	32
3.1.3.2.1 OSED Elementary Delegation Scenarios.....	46
3.1.3.2.1.1 Delegation with static AoR.....	46
3.1.3.2.1.2 Delegation of elementary sector, or partial sector, with dynamic AoR	46
3.1.3.3 Applicable standards and regulations	46
3.1.4 Capability Configurations required for the SESAR Solution	46
3.2 Changes imposed by the SESAR Solution on the baseline Architecture	52
3.2.1 Enablers Common to the three Architectures	52
3.2.2 Architecture "Y"	53
3.2.3 Architecture "D"	54
3.2.4 Architecture "U"	55
4 Technical Specifications.....	57
4.1 Functional architecture overview	57
4.1.1 VC-ADSP Resource Infrastructure view, common to Architectures "Y", "D " and "U"	61
4.1.2 Architecture "Y" - ATS Delegation with Common ADSP [PJ.10-W2-93A].....	62
4.1.2.1 Architecture "Y" - D0-Delegation Process Overview	63
4.1.2.2 Architecture "Y" - D4b-Abort Delegation	66
4.1.3 Architecture "U" - ATS Delegation with 2 ADSPs and Dynamic AoRs [PJ.10-W2-93C].....	68
4.1.3.1 Architecture "U" - D2-Enter Preview Mode	69
4.1.3.2 Architecture "U" - D5-Enter Operational Mode	72
4.1.3.3 Architecture "U" - D6-Exit Preview Mode of Delegating ATSU	75
4.1.4 Architecture "D" - ATS Delegation with 2 ADSPs and Static AoRs [PJ.10-W2-93B].....	77
4.1.4.1 Architecture "D" - D2-Enter Preview Mode.....	78
4.2 Functional and non-Functional Requirements.....	80
4.2.1 Functional Requirements	80
4.2.1.1 Technical Management of Delegation.....	81

4.2.1.1.1	Some Definitions	81
4.2.1.1.2	Assumptions.....	81
4.2.1.1.3	Delegation with Static AoR (Architectures "Y", "D").....	81
4.2.1.1.4	Delegation with Dynamic AoR (Architecture "U", "Y").....	88
4.2.1.1.5	Delegation with Static/Dynamic AoRs (Architectures "Y", "D", "U")	106
4.2.1.1.6	Preview Mode (Architectures "Y", "D", "U")	109
4.2.1.1.7	Switch Preview/Operational Mode (Architectures "Y", "D", "U").....	118
4.2.1.1.8	Technical Supervision for Delegation.....	129
4.2.1.2	Operational Configuration services (OPCONFM, OPCONFD)	134
4.2.1.2.1	Service Overview	134
4.2.1.2.2	Service Assumptions	135
4.2.1.2.3	Service Dependencies	135
4.2.1.2.4	Interface Interoperability requirements	138
4.2.1.2.5	Dynamic Behaviour requirements	141
4.2.1.2.5.1	Reference Behaviour Scenarios	141
4.2.1.2.5.1.1	Manage and Publish Sector Mapping.....	141
4.2.1.2.5.1.2	Get Sector Mappings.....	144
4.2.1.2.5.1.3	Manage and publish Radio Frequency Allocation	145
4.2.1.2.5.1.4	Manage and Publish Aerodrome Configurations	146
4.2.1.2.5.2	OPCONFM requirements	149
4.2.1.2.5.2.1	Requirements update and deletion of Sector Mappings	149
4.2.1.2.5.2.2	Requirements for activation of Sector Mappings	152
4.2.1.2.5.2.3	Requirements for loading of next Sector Mappings.....	154
4.2.1.2.5.2.4	Requirements for managing preview/operational mode	155
4.2.1.2.5.2.5	Requirements for updating a frequency or a frequency plan	158
4.2.1.2.5.2.6	Requirements for updating restricted airspace timetables	162
4.2.1.2.5.2.7	Requirements for managing the status of restricted airspaces	165
4.2.1.2.5.2.8	Requirements for managing Aerodrome Configurations.....	169
4.2.1.2.5.2.9	Generic requirements for values for all kinds of OPCONFM requests	173
4.2.1.2.5.3	OPCONFD requirements	174
4.2.1.2.5.3.1	Requirements for publication of Sector Mappings	174
4.2.1.2.5.3.2	Requirements for getting the Sector Mappings of an ATSU sector Configuration 176	
4.2.1.2.5.3.3	Requirements for publication of radio frequency allocation plan	177
4.2.1.2.5.3.4	Requirements for requesting a radio frequency allocation plan	178
4.2.1.2.5.3.5	Requirements for publication of Aerodrome Configurations	178
4.2.1.2.5.3.6	Requirements for getting the Aerodrome Configurations	179
4.2.1.3	Monitoring Aids Service (MONAD) [PJ.32-W3-02]	180
4.2.1.3.1	Service Overview.....	180
4.2.1.3.2	Service Assumptions	181
4.2.1.3.3	Service Dependencies	181
4.2.1.3.4	Interface Interoperability requirements	181
4.2.1.3.5	Dynamic Behaviour requirements	182
4.2.1.3.5.1	Reference Behaviour Scenarios	182
4.2.1.3.5.2	MONA requirements	183
4.2.1.3.5.2.1	Requirements for Trajectory Conformance	183
4.2.1.3.5.2.2	Requirements for Clearance Conformance	185
4.2.1.3.5.2.3	Requirements for Pilot Intent Monitoring.....	189
4.2.1.3.5.2.4	Requirements for Hold Monitoring.....	191
4.2.1.3.5.2.5	Requirements for Monitoring Restricted Airspace	193
4.2.1.3.5.2.6	Requirements for Monitoring Intruders.....	196
4.2.1.3.5.2.7	Subscription and publication.....	197
4.2.1.4	Technical Supervision Distribution Service (TECHSUPD) [PJ.32-W3-02]	199

4.2.1.4.1	Service Overview	199
4.2.1.4.2	Service Assumptions	199
4.2.1.4.3	Service Dependencies	200
4.2.1.4.4	Interface Interoperability requirements	200
4.2.1.4.5	TECHSUPD requirements	201
4.2.1.5	Other Virtual Centre Services [PJ.32-W3-02]	204
4.2.1.6	Functional Requirements for "Y" Architecture [PJ.32-W3-02]	204
4.2.1.7	Communication Infrastructure (VCCI) Requirements.....	211
4.2.1.7.1	Types of Requirements	211
4.2.1.7.2	Technical Infrastructure Requirements	211
4.2.1.7.3	Network Interface Binding	214
4.2.1.7.4	Service Interface Binding.....	215
4.2.2	Non-Functional Requirements	218
4.2.2.1	Time Performance Requirements	218
4.2.2.1.1	Time Performance Model	218
4.2.2.1.2	Identification of Transaction and Delivery Times per VC service.....	221
4.2.2.1.3	OPS Time Requirements.....	224
4.2.2.1.4	TECH Time Requirements.....	227
4.2.2.1.5	Preview/Operational Switch Requirements.....	228
4.2.2.2	Safety Requirements	229
4.2.2.3	Security Requirements	252
4.2.2.4	Reliability Requirements	264
4.2.2.5	Data Requirements.....	267
4.2.2.6	Adaptability Requirements.....	270
4.2.2.7	Maintainability Requirements.....	272
4.2.2.8	Regulation Requirements.....	273
5	Recommendation for Implementation.....	274
6	Assumptions	275
7	References and Applicable Documents	276
7.1	Applicable Documents	276
7.2	Reference Documents.....	277
Appendix A	Appendices	278
A.1	Solutions Related Functional Blocks/Roles & Enablers	278
A.2	Service Description Document (SDD).....	286
A.2.1	Airspace Status Distribution (ASD) [PJ.32-W3-02]	286
A.2.2	Coordination and Transfer Management Service (CTM) [PJ.32-W3-02].....	286
A.2.3	Correlation Distribution (CORRD) [PJ.32-W3-02]	286
A.2.4	Correlation Management (CORRM) [PJ.32-W3-02]	287
A.2.5	Flight Data Management Service (FDM) [PJ.32-W3-02].....	287
A.2.6	Flight Data Distribution Service (FDD) [PJ.32-W3-02]	287
A.2.7	Medium Term Conflict Detection (MTCDD) [PJ.32-W3-02]	287
A.2.8	Medium Term Conflict Management (MTCMD) [PJ.32-W3-02].....	287
A.2.9	Monitoring Aids Distribution (MONA) [PJ.32-W3-02].....	287
A.2.10	Operational Configuration Management Service (OPCONFM)	287
A.2.11	Operational Configuration Distribution Service (OPCONFD)	288
A.2.12	Safety Net Alert Service (SNET) [PJ.32-W3-02].....	288
A.2.13	SSR Code Distribution (SSRCD) [PJ.32-W3-02].....	288
A.2.14	SSR Code Management (SSRCM) [PJ.32-W3-02]	288

A.2.15	Technical Supervision Distribution (TECHSUPD) [PJ.32-W3-02]	288
A.3	Time Performances Analysis	288
A.3.1	OPCONFM and OPCONFD services.....	288

List of Tables

Table 1: Glossary	16
Table 2: Acronyms and terminology	21
Table 3: PJ.10-W2-93 Technological Solutions and POIs.....	28
Table 4: Recap of SESAR Technological Solutions PJ.10-W2-93 related POIs, Enablers and maturities	31
Table 5: Contingency and Delegation Operational Use Cases	45
Table 6: System Processes.....	46
Table 7: List of Capability Configuration required for the SESAR Solution	52
Table 8: Changes on Baseline Architecture Common	53
Table 9: Changes on Baseline Architecture "Y"	54
Table 10: Changes on Baseline Architecture "D"	55
Table 11: Changes on Baseline Architecture "U"	56
Table 12: Matching of NOV-5 and NSV-4 Views.....	58
Table 13: New functions required to perform the UC Operational Activities.....	61
Table 14: [OPCONF] Environmental conditions	135
Table 15: [MONA] Environmental conditions	181
Table 16: [TECHSUPD] Environmental conditions.....	200
Table 17: [VCCI] Protocols / YP Service Interface bindings mapping	216
Table 18: Categories of VC Service Response and Transit Times	222
Table 19: List of VC Service Response and Transit Times.....	224
Table 20: [OPCONF] Response and Transit Times.....	289

List of Figures

Figure 1: ADSP ATC Functional Blocks.....	25
---	----

Figure 2: ADSP Voice Functional Blocks 26

Figure 3: VC ATSU ATC Functional Blocks..... 26

Figure 4: Infrastructure Connectivity Model - Overall ATM as a Service 62

Figure 5: Resource Connectivity Model - Architecture “Y” 63

Figure 6: Architecture "Y" - D0-Delegation Process Overview 64

Figure 7: Architecture "Y" - D4b-Abort Delegation 67

Figure 8: Resource Connectivity Model - Architecture “U” 69

Figure 9: Architecture "U" - D2-Enter Preview Mode 72

Figure 10: Architecture "U" - D5-Enter Operational Mode..... 75

Figure 11: Architecture "U" - D6-Exit Preview Mode of Delegating ATSU 76

Figure 12: Resource Connectivity Model - Architecture “D” 77

Figure 13: Architecture "D" - D2-Entre Preview Mode 79

Figure 14: [OPCONFM/D] Reference Behaviour for Management of Sector Mapping 144

Figure 15: [OPCONFM/D] Reference Behaviour for Get Sector Configuration..... 145

Figure 16: [OPCONFM/D] Reference Behaviour for Management of Radio Frequency Allocation.... 146

Figure 17: [OPCONFM] Reference behaviour Aerodrome Group Configuration Management and Distribution..... 149

Figure 18: [MONA] Reference Behaviour for Subscription, Distribution and Un-subscription 183

Figure 19: Virtual Centre – Performance Model 220

1 Executive summary

This document provides the Final Technical Specification of three different technological solutions supporting the operational concept developed in the V3 OSED of PJ.10-W2-Solution 93: PJ.10-W2 Solution 93A, 93B and 93C. Those solutions propose three different architectures, of which two are based on Virtual Centre services developed in SESAR 2020 Wave 1 PJ.16-03, and Operational Concepts developed in SESAR 2020 Wave 1 PJ.15-09.

While Solution 93B and 93C are only reaching TRL4 at the end of Wave2, Solution 93A reaches TRL6 and allows OI SDM-217 of PJ.10-W2-Solution 93 to reach V3.

The three different architectures correspond to those identified and proposed by EUROCAE WG122: Architectures “Y”, “D” and “U”.

The supported PJ.10-W2-Solution 93 operational use cases are:

- Delegation of ATM services provision at night,
- Delegation of ATM Services Provision at fixed time,
- Cross-border delegation of ATM services with dynamic AoR for an elementary sector,
- Cross-border optimisation using delegation with static AoR,
- Delegation of ATM services provision following abnormal conditions (ATSU contingency)

This TS-IRS mostly analyses the delegation “Preview” functionality and two different ways of processing a delegation: without changing the AoRs of the ATSUs using architecture “Y” or “D”, or by changing the AoRs using architectures “U” or “Y”.

This TS-IRS also embeds the provision of improvements of the Virtual Centre service payloads provided by Solution PJ.32-W3-02, as well as new general requirements (i.e. not specific to delegation) that characterise the “Y” architecture. The improvements are late adjustments and refinements of the services initially delivered by PJ.16-03 and for some of them, have been deployed in PJ.10-W2-93 validation exercises. The development of the Triangle Architecture by PJ.32-W3-02 is provided in a dedicated FRD.

The main objectives of this TS-IRS document are:

- enhancement of the EATMA architecture with the proposed architectures,
- identification of the impacts on the overall architecture,
- development of functional and non-functional requirements specifying the technical behaviour for processing the delegations,
- development of interface requirements defining the structure of the messages exchanged for the delegation, and the meaning of the message payloads (provided as Service Description Document), and

- general improvements of the Virtual Centre service payloads (provided as Service Description Document)

This document is based on DS23 at the EATMA level.

2 Introduction

2.1 Purpose of the document

This document is the Technical Specification (TS/IRS) for technological Solution 93A, 93B and 93C of PJ.10-W2, and for hosting PJ.32-03 contribution to Virtual Centre service improvements and the “Y” architecture.

This document defines the architecture of each PJ.10-W2-93 technological solution, as well as the common interface requirements for the ATM Data Service Provider (ADSP) and the Virtual Centre ATSU (VC ATSU) necessary to support the various possible cases of delegation and contingency of ATM services between ATSU. It also integrates the SDDs of the Virtual Centre services for which the service payloads have been amended by PJ.32-03.

The TS/IRS provides the functional and non-functional requirements which are common to the architectures, as well as the specific ones.

In regards to the previous versions of the TS-IRS, this new version is mostly introducing the following points:

- Final view and set of POIs and Enablers, with their various target maturities
- Proper allocation of the Enablers to the requirements, with a refinement of the requirements for being assigned distinctly to the different ENs
- Moving to <validated> status the requirements successfully addressed by the validation exercises
- Introducing “Y” general functional requirements
- SDD annexes containing PJ.32-03 service evolutions

2.2 Scope

This is the final version of the TS/IRS document for PJ.10-W2.93 Technological Solutions 93A, 93B and 93C, with the outputs of the validation activities performed by the exercises. This version also integrates PJ.32-03 contribution to Virtual Centre architectures and services.

2.3 Intended readership

This document is mainly intended for:

- **SESAR JOINT UNDERTAKING (SJU)** as SESAR 2020 Programme coordinator.
- **SESAR 2020 PJ.10-W2** consortium members in order to be aware of activities and methods being used to allow for coherency, consistency and comparability of the validation results through all SESAR 2020 solutions.
- **SESAR 2020 PJ.10-W2-73** Flight Centred ATC and Improved Distribution of Separation Responsibility in ATC - Coordination contact(s)
- **SESAR 2020 PJ.09-W2-44** Dynamic Airspace Configuration (DAC) - Coordination contact(s)

- **SESAR 2020 PJ.32-W3-WP3** Virtual Centre for follow-up of Virtual Centre Concept evolutions
- **SESAR 2020 PJ.19-W2** Content Integration that aims at assuring coherency, consistency, and comparability of the validation results throughout all SESAR2020 Solutions.
- **SESAR 2020 PJ.20-W2** European Master Planning of objectives - Coordination contact (s)
- Representatives of civil stakeholders: **ANSPs**.

2.4 Background

PJ.10-W2- Solution 93 represents the continuation of the project PJ15-09 from SESAR 2020 wave 1 in which the first use cases of delegation and contingency of ATM services were produced. This project reached V1 in wave 1 and PJ.10-W2- Solution 93 is using its work for reaching V3 at the end of wave2.

This TS aims at defining the impact of the delegation use case with the services and the architectures defined by the virtual centre concept.

The Virtual Centre (VC) concept was originally explored in SESAR 1 B04.04, which first demonstrated its feasibility from a technical point of view.

In SESAR 2020 Wave 1, PJ.16-03 Solution was defined as an Enabling Solution to define and mature this technological concept. During the TRL2 Gate, a lack of operational definition was identified in the solution PJ.16-03 and was transferred to the solution PJ.15-09. Nevertheless, it was decided to continue PJ.16-03 as an Enabling Solution to reach TRL6 Gate at the end of Wave1 and reduce the scope of PJ15.09 to the definition of potential use cases for the delegation of airspace and contingency. PJ.10-W2-93 was then built as a follow up to the SESAR 2020 Wave 1 projects PJ15.09 "Delegation of airspace and contingency" and PJ16.03 "Enabling rationalisation of infrastructure using virtual centre based technology".

Therefore, this TS-IRS of Solution PJ.10-W2-93 is developed upon several background information:

- The operational concept and the identification and definition of the different use cases of ATM service delegation, as provided by PJ15.09.
- The requirements and service specifications provided in PJ16-03 TS-IRS, which serve as a basis for the development of the VC concept, as well as for the development of virtual centre services, to ensure the adequate support to the implementation of the different ATS delegation use cases.
- The outcomes from V2 phase

2.5 Structure of the document

- Chapter 1: Executive Summary.
- Chapter 2: Introduction. This chapter contains a general introduction, the scope and purpose of the document. This chapter also provides the glossary of terms, acronyms and terminology used in this TS.
- Chapter 3: SESAR Solution Impacts on Architecture. This chapter describes the architecture and relationships with EATMA.

- Chapter 4: Technical Specifications. This chapter forms the core of the document. It includes EATMA views and the functional and non-functional requirements for the Virtual Centre Architecture.
- Chapter 5: Recommendation for Implementation. This chapter provides possible options for the implementation of the VC architecture.
- Chapter 6: Assumptions. This chapter concerns the assumptions used for this technical specification.
- Chapter 7: References and Applicable Documents. This chapter lists the resources used throughout this document.
- Chapter 8: Appendices. This chapter provides the Service Description Documents (SDD) and the Time Performance Model.

The sections provided by PJ.32-W3-02 have headers titles tagged with “[PJ.32-W3-02]”

2.6 Glossary of terms

Term	Definition	Source of the definition
Area of Interest	The airspace encompassing the AoR and a defined buffer zone within which airspace status and flight information are of operational interest to the system operators.	ATM Lexicon
Area of Responsibility	An airspace of defined dimensions within which an ATC unit provides air traffic services.	ATM Lexicon
Data Element	A formalised representation of data. Data Elements are exchanged by Technical Systems when invoking operations in Service Interfaces or System Ports.	EATMA
Distribution of Control	Distribution of Control to an external ATSU (or "Distributed Control"): configuration where the working position of the external ATSU receiving the delegation (a.k.a. the receiving position) gets data for the delegated sectors from the ADSP of the delegating ATSU. This is performed within the AoRs of the delegating and receiving ATSUs which remain unchanged (i.e. "Static AoRs").	PJ.10-W2-93
Dynamic AoR	A delegation is said as processed with Dynamic AoRs when the control of the delegated sector is transferred from the AoR of the delegating ATSU to the AoR of the receiving ATSU. In this configuration, the receiving CWP's remain connected to the receiving ADSP.	PJ.10-W2-93
Extended AoR	AoR of the ATSU embedding one or several additional sectors, officially owned by neighbouring ATSUs, that can be delegated to the ATSU by a delegation processed with Dynamic AoRs.	PJ.10-W2-93

Functional Block	A logical and cohesive grouping of automated Functions in a Technical System.	EATMA
Operational Mode	A sector allocated to a CWP and not in preview mode is said as being in Operational Mode.	PJ.10-W2-93
Preview Mode	The Preview Mode is the temporary allocation, for consultation only, of sectors to a CWP for providing the user with a view of the traffic status before applying the delegation; i.e. during the preview phase of the delegation.	PJ.10-W2-93
Preview Mode - System Managed	Preview Mode where the system inhibits any request for instruction from the CWP in the consultation mode.	PJ.10-W2-93
Preview Mode - Procedures Managed	Preview Mode where the system does not inhibit requests for instruction from the CWP in the consultation mode. In this case, only the operational procedures forbid the input of requests in the consultation mode.	PJ.10-W2-93
Service	The contractual provision of something (a non-physical object), by one, for the use of one or more others. Services involve interactions between providers and consumers, which may be performed in a digital form (data exchanges) or through voice communication or written processes and procedures.	EATMA
Service Interface	The mechanism by which a service communicates. <i>Note: A Service Interface specifies the Service Interface Definition provided and required by the Service.</i>	EATMA
Service Interface Definition	The specification of the service interface.	EATMA
Static AoR	A delegation is said as processed with Static AoRs when the delegating ADSP keeps any delegated sector within its own AoR, but assigns its control to CWPs from the receiving ATSU, which previously subscribed to the delegating ADSP's services.	PJ.10-W2-93
System Port	A System Port is an interface provided by a Technical System. A System Port Connector asserts that a connection exists between two System Ports. Guidance: System ports are linked to Technical Systems that implement them. One System Port can be attached to many Technical Systems and one Technical System can have many System Ports. In addition, the System Ports can also be linked to the Capability Configurations that contain the Technical Systems to create views that describe technical interactions between Capability Configurations. System Ports and System Port Connectors are used to describe in detail the physical communication means used to transport the data	EATMA

	<p>from one system to another. To do so, the following elements are involved:</p> <ul style="list-style-type: none"> a) System Port specification, defining the ports on each system and the protocols/standards relevant for the port (HTTP, SOAP, TCP, IP, etc.) b) Technical System to System Port connectivity defined as a System Port Connector, i.e., the communication link between two system ports, which is enabled by a specific Communication system. Multiple System Ports and System Port Connectors can be used to specify the communication/network pathways through which systems interface. 	
SWIM Technical Infrastructure (SWIM-TI)	The SWIM Technical Infrastructure (SWIM-TI) contributes to the services' solution, aspects providing means supporting effective and secure ATM-specific service provision and consumption among SWIM-enabled ATM systems.	SESAR1 WP14
Technical System	<p>A collection of Functional Blocks or Functions. Guidance:</p> <p>Technical Systems are artefacts that represent the technical part of Capability Configurations and contain Functional Blocks.</p> <p>Interaction between Technical Systems can be described via Resource Interactions (normally for legacy exchanges) and via Services (normally, for new exchanges). Both interactions carry Data elements.</p> <p>A Technical System comprises a set of System Ports that are the part of the Technical System in charge of implementing such data exchanges.</p> <p>Technical Systems can be linked to Functions that represents what the Technical System does.</p>	EATMA
Virtual Centre	A virtual centre is a single Air Traffic Service Unit (ATSU) or a grouping of collaborative ATSUs using data services provided by ATM Data Service Provider (ADSP). The concept provides, at least, geographical decoupling between ADSP (s) and some ATSU (s), through service interfaces defined in Service Level Agreements. One ATSU may use data services from multiple ADSPs, just as an ADSP may serve multiple ATSUs.	PJ.16-03 solution

Table 1: Glossary

2.7 Acronyms and Terminology

Term	Definition
A/G	Air/Ground
AAA	Authentication, Authorisation, Auditing service
ACC	Area Control Centre

ADD	Architecture Description Document
ADES	Aerodrome of Destination
ADSP	ATM Data Service Provider
AIRAC	Aeronautical Information Regulation And Control
AIRM	ATM Information Reference Model
AMQP	Advanced Message Queuing Protocol
ANSP	Air Navigation Service Provider
AoR	Area of Responsibility
APP	Approach control office
ARES	Airspace Reservation
ASD	Airspace Status Distribution service
ATC	Air Traffic Control
ATCO	Air Traffic Controller
ATFCM	Air Traffic Flow and Capacity Management
ATM	Air Traffic Management
ATS	Air Traffic Services
ATSP	Air Traffic Service Provider
ATSU	Air Traffic Services Unit
C&T	Coordination & Transfer
CBA	Cost Benefit Analysis
CC	Capability Configuration
CDR	Conditional Route
CNS	Communication Navigation and Surveillance
CONOPS	Concept of Operations
COTS	Commercial-Off-The-Shelf
CR	Change Request
CSF	Cyber Security Framework

CTM	Coordination and Transfer Management service
CWP	Controller Working Position
DAC	Dynamic Airspace Configuration
DNS	Domain Name System
DNSSEC	Domain Name System Security Extensions
DT	Delivery Time
EATMA	European ATM Architecture
EASA	European union Aviation Safety Agency
EN	Enabler
ENCRYPT	European Network of Excellence in Cryptology
E-OCVM	European Operational Concept Validation Methodology
FB	Functional Block
FDD	Flight Data Distribution service
FDPS	Flight Data Processing System
FDM	Flight Data Management service
FO	Flight Object
FRD	Functional Requirements Document
G/G	Ground/Ground
HMI	Human Machine Interface
HPAR	Human Performance Assessment Report
HTTP	Hypertext Transfer Protocol
HTTPS	Hypertext Transfer Protocol Secure
IAF	Initial Approach Fix
IAP	Instrument Approach Procedure
ICAO	International Civil Aviation Organization
IBP	Industrial Based Platform
ID	Identifier

IDPS	Intrusion Detection and Prevention System
IER	Information Exchange Requirement
IRS	Interface Requirements Specification
INTEROP	Interoperability Requirements
IP	Internet Protocol
IRS	Interface Requirements Specification
ISRM	Information Services Reference Model
LAN	Local Area Network
LoA	Letter of Agreement
NA	Not Applicable
NAF	NATO Architecture Framework
NET	Network
NFR	Non-Functional Requirements
NIST	National Institute of Science and Technology
NSOV	NAF Service Oriented View
NOV	NAF Operational View
NSV	NAF System View
OI	Operational Improvement
OLDI	On-Line Data Interchange
OPSUP	Operational Supervision
OPSUPD	Operational Supervision Distribution service
OPSUPM	Operational Supervision Management service
OPSUPWP	Operational Supervision Working Position
OSED	Operational Service and Environment Definition
PKI	Public Key Infrastructure service
REST	Representational State Transfer
SDD	Service Description Document

SESAR	Single European Sky ATM Research Programme
SFPL	System Flight Plan
SJU	SESAR Joint Undertaking (Agency of the European Commission)
SOAP	Simple Object Access Protocol
SPR	Safety and Performance Requirements
SSRCD	SSR Code Distribution service
SSRCM	SSR Code Management service
SWIM	System Wide Information Model
TBSD	Time Based Separation Distribution service
TBSM	Time Based Separation Management service
TCP	Transmission Control Protocol
TRL	Technology Readiness Level
TS	Technical Specification
TT	Transaction Time
TVALP	Technical Validation Plan
TVALR	Technical Validation Report
UC	Use Case
VALP	Validation Plan
VALR	Validation Report
VALS	Validation Strategy
VC	Virtual Centre
VCCI	Virtual Centre Communication Infrastructure
VCD	Voice Communication Distribution service
VCM	Voice Communication Management service
VCS	Voice Communication System
WAN	Wide Area Network

WS	Web Services
WSDL	Web Services Description Language
XML	Extensible Markup Language
YP	Yellow Profile

Table 2: Acronyms and terminology

3 SESAR Solution Impacts on Architecture

3.1 Target Solution Architecture

3.1.1 SESAR Solution(s) Overview

The delegation of ATM services provision concept applies when one ATSU delegates a portion of its airspace, or the entire airspace, to another ATSU based on a particular condition. The Solution 93 investigates Use Cases for the Delegation of ATM and Contingency in conjunction with the Virtual Centre Technology where the ATM Data Service Provider (ADSP) is geographically separated from the Virtual Centre ATSU providing ATS to a region of airspace.

Based on the new operational opportunities offered by the Virtual Centre concept, a preliminary set of Delegation and Contingency Uses Cases have been selected, with the aim to further investigate and develop dynamic airspace configuration and advanced ATFCM capabilities. These will allow a completely new architecture to provide Air Traffic Services. These Use Cases will consider the operational procedures and resource management to support static and dynamic delegation of ATS, and will be identified before defining the Operational and Technical Requirements for different architectures.

Additionally, in the context of Virtual Centre, the Virtual Centre ATSUs may use Data Services from multiple ATM Data Service Providers, just as one ADSP may serve multiple VC ATSUs.

This agility will lead to greater opportunities to provide Air Traffic Services, both from a technical and an operational view, leading to flexible use of resources, which in turn leads to improved overall Performance.

In SESAR, the ATC Systems/ Subsystems supporting the Virtual Centre concept (ADSP ATC, ADSP voice and VC ATSU) are presented and drawn in the following figures (Source EATMA, relevant dataset DS23). The Functional Blocks applicable to each system and impacted by the Virtual Centre concept are represented as well.

3.1.2 From Architecture Views to SESAR Solutions

PJ.10-W2-93 has early brought out various ways of managing delegations of ATM services through different set-ups of Virtual Centres, where:

- ATSUs sharing a common ADSP can directly handle Airspace pieces of the other ATSU by just allocating the relative sector(s) to their own control positions
- ATSUs can provide control positions and use interoperability capabilities of the ADSPs for just connecting their own control positions to the ADSP of another ATSU and take the control of the delegated sectors
- Delegated sectors are coordinated for being moved from an ATSU supported by an ADSP to the ADSP of another ATSU

WG122 has worked for providing a clear and official taxonomy of these set-ups, now respectively referenced as Architecture “Y”, “D” and “U”.

- “Y”: Centralised option

In this option, multiple ATSUs are connected to the same ADSP. ATSUs may or may not belong to the same ANSP.

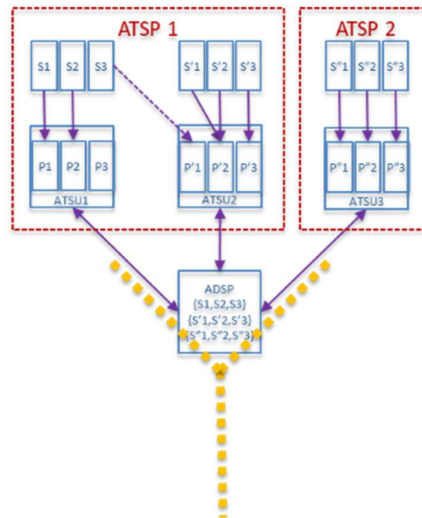

The three ATSUs are connected to the same ADSP and behave as if they were part of one system

The “Y” option allows complete flexibility among all connected ATSUs but is not easily re-configured to manage new ATSUs.

- “D”: ATSU-ADSP re-allocation model

In this option, positions in one ATSU can connect to a different ADSP managing the sectors they need to control:

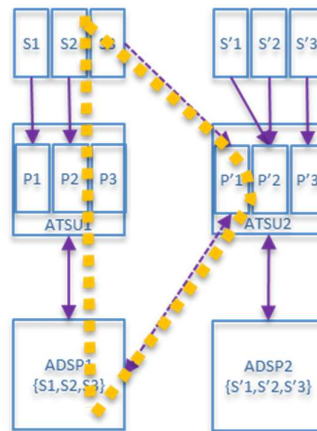

The two ATSU's shown above may or may not belong to the same ANSP.

- “U”: the ADSP variable scope model or “U” model

In this model airspace delegation is managed thanks to the ability of the ADSP to manage additional sectors not initially belonging to its AOR.

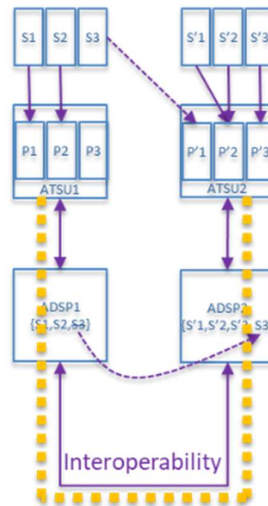

The two ATSU's shown above may or may not belong to the same ANSP.

Those 3 architectures are handled by 3 different technological solutions supported by their own set of Enablers, of which some are common:

- PJ.10-W2-93A: “Y”
- PJ.10-W2-93B: “D”
- PJ.10-W2-93C: “U”

3.1.3 Architectures Details

Whatever the Virtual Centre architecture, the spreading of the Functional Blocks between the VC Capability Configuration and the ADSPs Capability Configuration does not vary and is depicted in the following diagrams.

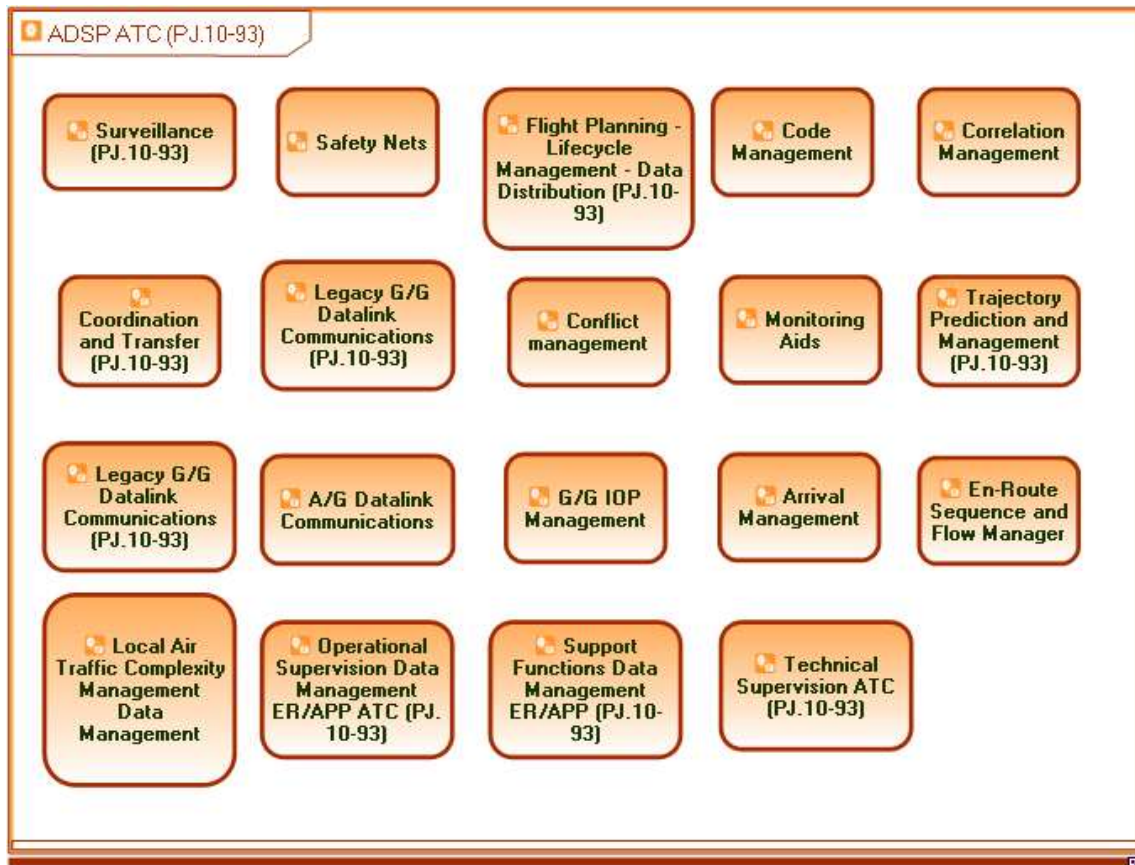

Figure 1: ADSP ATC Functional Blocks

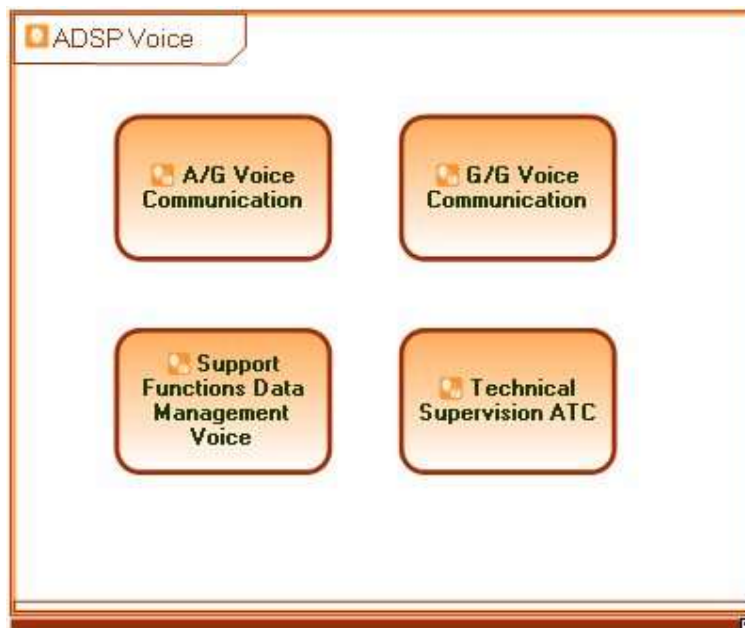

Figure 2: ADSP Voice Functional Blocks

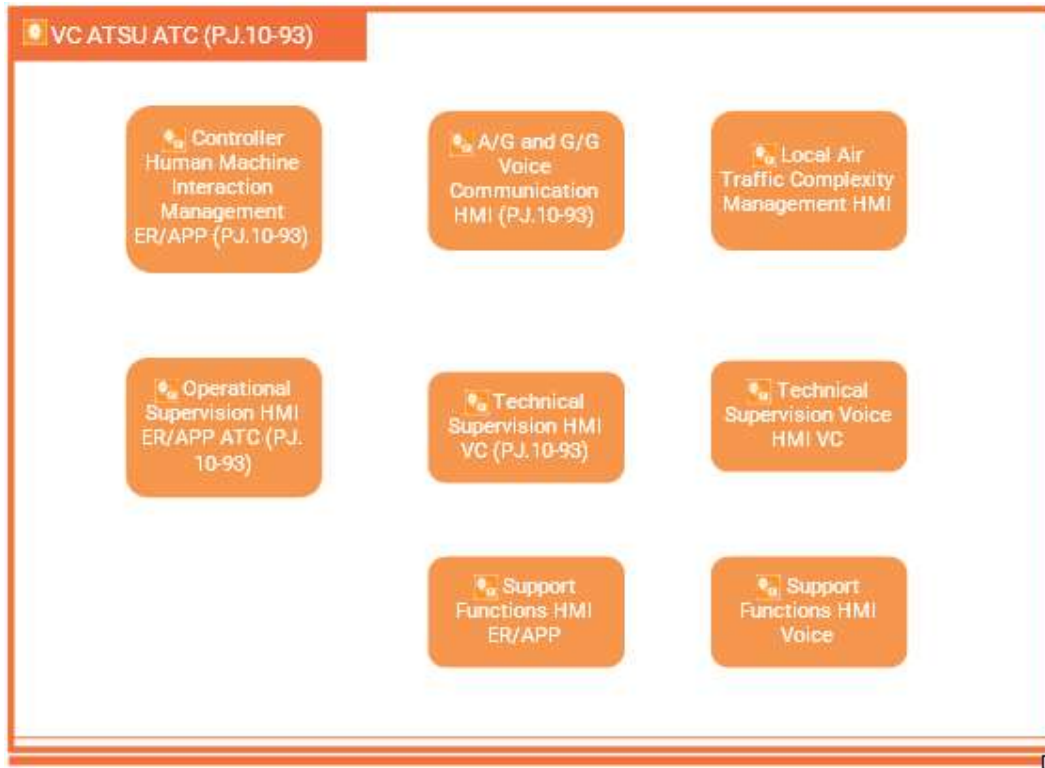

Figure 3: VC ATSU ATC Functional Blocks

The difference between the various architectures resides in the different Capability Configuration setups and behaviours that are presented in section 4.1. The Requirements provided in section 4.2 are also architecture dependant.

Those architectures have been processed by 3 different technological solutions, each one having its own POI for hosting the set of specific Enablers.

PJ.10-W2-93A reaching TRL6, the link from POI-0075 to SDM-0217 of PJ.10-W2-93 is promoting this solution to V3.

The table below recaps the Technological Solutions with their respective POIs.

Solution PJ.10-W2-93A Delegation of ATM services provision with a “Y” architecture

The delegation of ATM services provision, as described by the OI “SDM-0217_Delegation of ATM Services provision between ATSUs”, may be achieved with different system architectures. This solution focuses on the “Y” architecture relying on a delegation between 2 ATSUs sharing the same ADSP and not impacting their respective AoRs.

POI-0075 Y-Architecture supporting use of Virtual Centre concept for delegation of ATM services provision amongst ATSUs

The provision of Virtual Centre standardised services allows an ADSP to provide ATM data to several ATSUs with a common core system. Such a configuration allows straight forward delegation of ATM Services provision between those ATSUs, where CWP from the receiving ATSU are able to receive the expected ATM data without affecting the respective ATSU AoRs. This one-ADSP-to-several-ATSUs configuration is referenced as a 'Y' architecture.

This architecture is deployed with the use of standard VC services in the first place, but it may be also deployed with the use of proprietary interfaces, thus making the use of the standard VC services optional. The use of proprietary interfaces within a 'Y' Architecture is then referred as "Legacy 'Y' architecture" whenever there is the need to distinguish the two cases.

'Y' architecture is also well fitted for supporting ATSU contingency scenarios.

This POI is valid for En-Route and TMA phases of flight.

Solution PJ.10-W2-93B Delegation of ATM services provision with a "D" architecture

The delegation of ATM services provision, as described by the OI "*SDM-0217_Delegation of ATM Services provision between ATSUs*", may be achieved with different system architectures. This solution focuses on the "D" architecture relying on a delegation between 2 ATSUs, each with its own ADSP, and using Virtual Centre (service) interoperability for remotely connecting CWPs to one or the other ADSP, without affecting the respective AoRs.

POI-0076 D-Architecture supporting use of Virtual Centre concept for delegation of ATM services provision amongst ATSUs

The provision of Virtual Centre standardised services allows a CWP to subscribe to services of different ADSPs. In particular, an ATSU supported by a specific ADSP can delegate ATM services provision to another ATSU, served by another ADSP, by just allowing CWPs of this ATSU to subscribe to the other ADSP services, thus keeping the ATSU AoRs unchanged. This delegation configuration set-up is referenced as the 'D' architecture.

This architecture is deployed with the use of standard VC services in the first place, but it may be deployed with the use of proprietary interfaces common to the ADSPs, thus making the use of the standard VC services optional. The use of proprietary interfaces within a 'D' Architecture is then referred as 'Legacy 'D' architecture' whenever there is the need to distinguish the two cases.

'D' architecture is also well fitted for supporting ATSU contingency scenarios.

This POI is valid for En-Route and TMA phases of flight but has only been validated for En-Route.

Solution PJ.10-W2-93C Delegation of ATM services provision with a "U" architecture

The delegation of ATM services provision, as described by the OI "*SDM-0217_Delegation of ATM Services provision between ATSUs*", may be achieved with different system architectures. This solution

focuses on the “U” architecture relying on a delegation between 2 ATSUs, each with its own system, and using exchange capabilities between the 2 systems for transferring relevant data to the ATSU receiving the delegation. Each system may be a legacy one or be provided by an ADSP (i.e. “I” architecture). In this architecture, the respective AoRs are reshaped according to the delegation.

POI-0077 U-Architecture supporting Infrastructure for delegation of ATM services provision amongst ATSUs

A delegation of ATM services provision may be achieved by transferring an ATSU AoR, or a piece of AoR, to another ATSU. In this set-up, the receiving ATSU provides both the CWPs and an extension of its AoR in the system, while at the same time the AoR of the delegating ATSU is reduced accordingly. This principle is based on the capability of the systems to exchange the required information at the right time in order to provide the relevant information to the CWPs taking the delegation(s). This delegation configuration set-up is referenced as the 'U' architecture.

This architecture can be applied to any combination of Virtual Centres and/or non-Virtual Centres. Therefore, the use or not of the VC Enablers is not directly relevant for this architecture.

'U' architecture is also well fitted for supporting ATSU contingency scenarios.

This POI is valid for En-Route and TMA phases of flight but has only been validated for En-Route.

Table 3: PJ.10-W2-93 Technological Solutions and POIs

The table below depicts a synthetic view of the current Enabler allocations per Technological Solution and their validation coverage at the end of the projects (full detailed tables are provided in A.1):

Enabler	Service	Sol93A POI-0075 "Y"	Sol93B POI-0076 "D"	Sol93C POI-0077 "U"	Initial Maturity	Target Maturity
SVC-008	Provision and Consumption of Flight Data Distribution Service in the context of Virtual Centres.	Optional	Optional	n/a	TRL6	TRL6
SVC-009	Provision and Consumption of Flight Data Management Service in the context of Virtual Centres	Optional	Optional	n/a	TRL6	TRL6
SVC-010	Provision and Consumption of Coordination And Transfer Management Service in the context of Virtual Centres	Optional	Optional	n/a	TRL6	TRL6
SVC-013	Provision and Consumption of Airspace Status Distribution Service	Optional	Optional	n/a	TRL6	TRL6
SVC-014	Provision and Consumption of Arrival Sequence Distribution Service	Optional	Optional	n/a	TRL4	TRL4
SVC-015	Provision and Consumption of Arrival Sequence Management Service	Optional	Optional	n/a	TRL4	TRL4
SVC-016	Provision and Consumption of Correlation Distribution Service	Optional	Optional	n/a	TRL6	TRL6
SVC-017	Provision and Consumption of Correlation Management Service	Optional	Optional	n/a	TRL6	TRL6
SVC-018	Provision and Consumption of Medium Term Conflict Detection Distribution Service	Optional	Optional	n/a	TRL4	TRL4
SVC-019	Provision and Consumption of Medium Term Conflict Management Service	Optional	Optional	n/a	TRL4	TRL4
SVC-020	Provision and Consumption of Monitoring Aids Distribution Service	Optional	Optional	n/a	TRL4	TRL6
SVC-021	Provision and Consumption of Operational Configuration Distribution Service	Optional	Optional	n/a	TRL4	TRL6
SVC-049	Operational Configuration Distribution of Working Position Preview Mode, and Neighbouring ATSU Sector configuration for ATM Service Delegation	Optional	Optional	n/a	new	TRL6
SVC-022	Provision and Consumption of Operational Configuration Management Service	Optional	Optional	n/a	TRL4	TRL6

SVC-050	Operational Configuration Management of Working Position Preview Mode, and Neighbouring ATSU Sectors for ATM Service Delegation	Optional	Optional	n/a	new	TRL6
SVC-023	Provision and Consumption of Safety Net (SNET) Alert Distribution Service	Optional	Optional	n/a	TRL4	TRL4
SVC-024	Provision and Consumption of SSR Code Distribution Service	Optional	Optional	n/a	TRL4	TRL
SVC-025	Provision and Consumption of SSR Code Management Service	Optional	Optional	n/a	TRL4	TRL4
SVC-026	Provision and Consumption of Support Functions Distribution Service	Optional	Optional	n/a	TRL4	TRL4
SVC-027	Provision and Consumption of Support Functions Management Service	Optional	Optional	n/a	TRL4	TRL4
SVC-028	Provision and Consumption of Surveillance Data Distribution Service	Optional	Optional	n/a	TRL4	TRL4
SVC-029	Provision and Consumption of Technical Supervision Distribution Service	Optional	Optional	n/a	TRL4	TRL6
SVC-031	Provision and Consumption of Time-based Separation Distribution Service	Optional	Optional	n/a	TRL4	TRL4
SVC-032	Provision and Consumption of Time-based Separation Management Service	Optional	Optional	n/a	TRL4	TRL4
SVC-033	Provision and Consumption of Voice Comm Information Distribution Service	Optional	Optional	n/a	TRL6	TRL6
SVC-034	Provision and Consumption of Voice Comm Management Service	Optional	Optional	n/a	TRL6	TRL6
ER APP ATC 184	ATM Data Service Provider for ATC services in a Virtual Centre context	Required	Required	n/a	TRL6	TRL6
ER APP ATC 185	ATM Data Service Provider for Voice services in a Virtual Centre context	Required	Required	n/a	TRL6	TRL6
ER APP ATC 186	Virtual Centre ATSU	Required	Required	n/a	TRL6	TRL6

ER APP ATC 193	Management in the VC ATSU of a CWP preview mode during delegation of ATS Provision between ATUs	Required	Required	Optional	new	TRL6
ER APP ATC 194	Management in the ADSP of a CWP preview mode during delegation of ATS Provision between ATUs	Required	Required	Optional	new	TRL6
ER APP ATC 195	Management in the VC ATSU of Delegation of ATS Provision between ATUs with Static AoRs for Y-Architecture	Required	n/a	n/a	new	TRL6
ER APP ATC 196	Management in the VC ATSU of Delegation of ATS provision between ATUs with Dynamic AoRs for U-Architecture	n/a	n/a	Required	new	TRL4
ER APP ATC 197	Management in the ADSP of Delegation of ATS provision between ATUs with Dynamic AoRs for U-Architecture	n/a	n/a	Required	new	TRL4
ER APP ATC 215	Management in the VC ATSU of Delegation of ATS Provision between ATUs with Static AoRs in a D-Architecture	n/a	Required	n/a	new	TRL4
ER APP ATC 216	Management in the ADSP of Delegation of ATS provision between ATUs with Static AoRs in a Y-Architecture	Required	n/a	n/a	new	TRL6
ER APP ATC 217	Management in the ADSP of Delegation of ATS provision between ATUs with Static AoRs in a D-Architecture	n/a	Required	n/a	new	TRL4
ER APP ATC 218	Management in the VC ATSU of Delegation of ATS provision between ATUs with Dynamic AoRs in a Y-Architecture	Optional	n/a	n/a	new	TRL6
ER APP ATC 209	Management in the ADSP of Delegation of ATS provision between ATUs with Dynamic AoRs in a Y-Architecture	Optional	n/a	n/a	new	TRL6
STD-097	EUROCAE ER for Taxonomy of Services between ATSU & ADSP(s), and between ADSP & ADSP	Optional	Optional	n/a	TRL4	TRL4

Table 4: Recap of SESAR Technological Solutions PJ.10-W2-93 related POIs, Enablers and maturities

3.1.3.1 Deviations with respect to the SESAR Solution(s) definition

As described in the previous section, 3 new unplanned technological solutions have been created in the project for structuring the development of different technical architecture options in support to the main ATM solution, thus allowing different levels of maturity to be reached for the proposed technical architectures.

3.1.3.2 Relevant Use Cases

The V3 OSED of Solution 93 provides the operational use cases that are expected to be validated in the V3 phase. The following operational use cases are described in the OSED:

- Delegation of ATM Services Provision at Night

Traffic is usually decreasing during the night-hours. Therefore, at night ATM can be consolidated in fewer ATSU, which provides economic benefits, in particular when sectors can be enlarged during night-time, so that less controllers are required.

- Delegation of ATM Services Provision at fixed Time

This case is rather similar to the previous one, but where the night delegation rather applies on a complete ATSU, this one is limited to few sectors.

- Delegation between Civil and Military ATSUs

This use case explores both the Delegation of ATM services provision between a civil and a military ATSU and Delegation of ATM services provision for an airspace where military activity is planned or is already taking place. This case is not considered in this TS document because it is addressed by the PJ.32-W3-01 TS document.

- Cross-border Delegation (with static or dynamic AoRs)

These use cases focus on delegation of ATM services between adjacent ATSUs. The aim of these use cases is the optimisation of traffic flows along the common border of the adjacent units for operational reasons (e.g. decreasing traffic, ATCOs engagement plan, economy of scale).

The following cases are not considered in this TS document because they are addressed by the PJ.32-W3-01 TS document.

- Delegation of the ATFCM service and load balancing between ATSUs

In this use case, the delegation of the ATFCM service itself between ATSUs is explored.

- Delegation of ATM services Provision following abnormal conditions

The ATSU Contingency use case is related to a severe failure taking place at the ATSU premises at a random point in time. This severe event results in the impossibility of the ATSU to further control its associated airspace. In these cases, ATM services provision needs to be delegated to another ATSU or several ATSUs in order to provide ATM services to the airspace users.

During the analysis of the use cases, it was perceived that a generic procedure for all use cases under normal conditions, and for contingency, is essential.

From the ATCO's perspective, it is essential that the act of delegating the ATMS service provision to an ATCO team in a separate ATSU is always identical and independent of the trigger. Therefore, the use cases listed above can be regarded as triggers for the Contingency Procedure and the Delegation Procedure described in the following Tables.

Moreover, the procedure is considered as technology agnostic and applies whatever the technical architecture chosen. The three architectures “Y”, “D” and “U” are applicable to any of the addressed operational use cases above.

Operational Use Case	Description
[NOV-5] Architecture D - D2-Enter Preview Mode	This view drafts what could be the procedure for delegating by distributing control over 2 ADSPs. Mostly: - CWP subscription/unsubscription to move from one ADSP to the other one - Life Line of activities moving from the receiving SPV to the delegating SPV - Most likely supplementary coordination actions between supervisors, and between receiving ATCOs and delegating SPV
[NOV-5] Architecture U - D2-Enter Preview Mode	The Enter Preview Mode phase in an environment comprising multiple ADSPs is depicted in this view. Since the involved ADSPs are not synchronised among themselves, the Supervisors of the delegating and the receiving ATSU need to independently decide the required sector configuration for the delegation. The necessary changes need to be implemented in each ADSP separately. They need to be clearly coordinated between the Supervisors while agreeing on the coordination and particular focus has to be put on the implementation of the changes to make sure the ADSPs do not have diverging configurations afterwards.
[NOV-5] Architecture U - D5-Enter Operational Mode	The view depicts the Enter Operational Mode phase in a multiple ADSP environment. In order to properly switch into Operational Mode at the receiving ATSU and into Preview Mode at the delegation ATSU, both Supervisors need to coordinate by phone in order agree on the switch. After the agreement, the switch needs to be implemented on both sides in order to be in the correct state in both ATSUs and to ensure that only one sector team is in charge at a time. It is critical that the Supervisor of the receiving ATSU is initiating the synchronisation with the Supervisor of the delegating ATSU, since only the receiving ATCO team can determine whether the handover of the traffic is completed and the responsibility of the sector can be transferred. During the synchronisation via phone, the two Supervisors need to

	<p>make sure that the switch between Preview Mode and Operational Mode and vice versa is done almost simultaneously in both ATSUs in order to ensure that only one ATSU is in charge of a sector at any time.</p> <p>In this configuration each ADSP is only managing the CWP configurations of its associated ATSUs.</p>
<p>[NOV-5] Architecture U - D6-Exit Preview Mode of Delegating ATSU</p>	<p>The view depicts the Exit Preview Mode phase of Delegating ATSU in an environment with multiple ADSPs that are not synchronised. As described in the previous view, a phone coordination between the Supervisors of the receiving and the delegating ATSU is required. The Supervisor of the receiving ATSU is informing the Supervisor of the delegating ATSU that the Preview Mode can be exited on the delegating side. The Supervisor of the delegating ATSU is then requesting the exit of the Preview Mode at its ADSP.</p>
<p>[NOV-5] C0-Contingency Procedure Overview - Architecture Y</p>	<p>The contingency procedure depicted in the view is aligned with the Contingency Lifecycle defined by Eurocontrol. The Contingency Lifecycle starts with an unexpected severe event that causes the failure of an ATSU.</p> <p>Contingency cases can be quite diverse: in some cases, an immediate clear-the-sky maybe essential, e.g. if the ATSU needs to be evacuated, while in other cases there might be the possibility to delegate to aiding ATSUs, e.g. if the ATSU is technically impacted but still able to ensure safe operations with reduced capacity.</p> <p>For the definition of the contingency procedure the following assumption has been taken:</p> <ul style="list-style-type: none"> • The procedure currently covers the case of a contingency case at an ATSU. Therefore, it is assumed that the ADSP is not affected by the ATSU failure and thus is still able to provide data to other ATSUs that are not impacted. <p>When a failure occurs at the ATSU, it is the responsibility of the Supervisor to decide if it is a contingency case or not. If yes, all impacted actors of the ATSU need to be informed. After this, the Supervisor needs to check if immediate action is required, e.g. the control room needs to be evacuated immediately. In such a case the only option would be to clear-the-sky. If there is more time available to react on the failure, there will the opportunity to initiate a contingency delegation, i.e. the delegation procedure will be used to delegate the provision of ATM services for an affected sector. This might not be possible for all sectors of an ATSU, but it would at least offer the opportunity to keep parts of the airspace of the failing ATSU open while the other parts of the airspace might need to be cleared. In any case a service continuity preparation would take place in aiding units in order to ensure sufficient airspace capacity for the duration of the contingency.</p>

<p>[NOV-5] C1-Degraded Mode/Emergency</p>	<p>This phase describes the process flow that is performed when an unexpected and severe failure causes the outage of an ATSU.</p> <p>The first thing to do for the Supervisor is to decide whether there is a Contingency situation or not. The reasons for ATSU Contingency cases may be quite diverse. They might range from operational issues over technical issue to disaster situations such as fires in control rooms or equipment rooms. The Supervisor is responsible to declare a Contingency situation at the ATSU. To come to this decision, all relevant experts are asked for advice, such as ATSEPs. If there is a contingency situation, the Supervisor needs to inform the ATCOs currently working in the ATSU about the Contingency situation so they are aware of the situation and wait about further instructions about how the Contingency situation will be handled.</p>
<p>[NOV-5] C2-Contingency Delegation</p>	<p>In a non-Virtual Centre environment, there is almost only the option to clear-the-sky, evacuate the building and relocate ATCOs to the Contingency premises. The technical flexibility expected from Virtual Centre should provide improvements in operations, especially offering means for Contingency that were not existing before.</p> <p>Since the event causing the Contingency and its severity are unpredictable, it is very difficult to anticipate how much time an ATSU has available to deal with an emergency. There might be a fire in the building allowing the ATCOs to have very little coordination with adjacent ATSUs. In case of a flood and a rising water level, there might be more time to react, but there are also situations like earthquakes that would immediately neutralise the ATSU without having the chance to deal with the situation. The process flow depicted in the view needs to be interpreted keeping in mind this time dimension of the Contingency cases.</p> <p>The added value is to have the possibility to have Contingency Delegation of some sectors, if time permits. If possible, the Supervisor of the failing ATSU can try to contact an aiding ATSU (in the respect of pre-determined procedures) and ask for immediate support for the airspace of the failing ATSU by Contingency Delegation. This would allow for a clean handover of the airspace to an aiding unit using the delegation procedure. When receiving a contingency request, the Supervisor of the aiding ATSU will check whether the aiding ATSU is able to immediately provide Contingency Delegation services for the affected airspace.</p> <p>If the aiding ATSU is immediately able to provide Contingency Delegation services, the ATM services provision will be delegated according to the delegation procedure starting with the Preview Mode phase. This is a decision that will be made</p>

	<p>per sector of the failing ATSU. It is very likely that the aiding ATSU is not able to provide Contingency for all sectors of the failing ATSU, but only for a few of them. On the other hand, there might be more than one aiding ATSU being able to provide Contingency service.</p> <p>If the aiding ATSU is not immediately able to provide Contingency Delegation services, then the failing ATSU needs to clear-the-sky in order to ensure safe operations and the aiding ATSU is obliged to support as soon as possible. Therefore, activities are carried out to prepare the Service Continuity phase.</p>
<p>[NOV-5] C3-Clear-the-Sky</p>	<p>If no immediate Contingency Delegation can be provided by aiding units or if the Contingency event does not allow to coordinate with aiding ATSUs, the Supervisor of the failing ATSU instructs the ATCO teams of the failing unit to clear-the-sky.</p> <p>Initially, the Supervisor of the failing ATSU notifies the Network Manager about the initiation of the clear-the-sky procedure at the ATSU. Besides the Network Manager, all adjacent ATSUs and the ADSP are also informed by the Supervisor of the failing ATSU. Furthermore, the Supervisor of the failing ATSU instruct their NOTAM office to publish a prepared NOTAM for a No-Fly zone declaration. In addition, the ATCOs of the failing ATSU are instructed by the Supervisor to clear-the-sky.</p> <p>In general, during a contingency situation, the work-sharing between Executive and Planner would not be as strict as outlined in Figure 40, but both would try to handover aircraft to other units simultaneously. In order to not overcomplicate the diagram, the activities were not duplicated.</p> <p>To clear-the-sky, the ATCO team needs to handover as quickly as possible the aircraft in their sector to other units. This may be an upper or lower unit in case of a vertically split airspace or an adjacent unit from the flight path of the aircraft. An important prerequisite is that the ATSU taking over has the aircraft in its radar coverage. If an aircraft cannot be handed over to another unit, the aircraft will be instructed to fly according to its flight plan and to try to contact the next sector on the appropriate frequency as soon as possible. If an aircraft can be handed over successfully, the flight needs to be updated, therefore involving an interaction with the ADSP.</p> <p>In addition, the ATCO team needs to make sure that no further aircraft enter the airspace. Therefore, all departures need to stay on the ground and aircraft entering from adjacent sectors need to be redirected.</p> <p>When Clear-the-Sky is initiated it may take between 15 to 60 minutes until there are no more aircraft in the airspace, depending on the size of the affected airspace. In cases of severe failures on the ATSU side, aircrafts maybe required to</p>

	<p>strictly follow their flight plan until they get contact to the next unit.</p> <p>After the ATCO team has successfully cleared the sky, they inform their Supervisor that their sector is cleared. The Supervisor takes the decision and closes the sector. This involves the ADSP where measures are taken to configure the system and distribute a new sector configuration. After the sector closure the Supervisor informs the Flow Manager, who forwards this information to the Network Manager who will put ATFCM restrictions in place.</p>
<p>[NOV-5] C5-Service Continuity</p>	<p>If an aiding ATSU could not activate contingency delegation procedures, it is obliged to provide contingency services as soon as possible for the airspace of the failing ATSU as part of the Service Continuity. Therefore, the shift plan to bring in additional ATCOs for providing Contingency services for the airspace of the failing ATSU. Consequently, a new sector opening plan needs to be defined. It is worth mentioning that these preparatory activities might need from a few hours up to 48 hours, because the ATCOs need to be contacted and then they need to commute to the aiding ATSUs premises.</p> <p>After the aiding ATSU has prepared to provide Contingency services for the airspace of the failing ATSU, sectors that have been closed before are reopened again step-by-step. Over time more and more sectors can be reopened which have been cleared and closed before. This has the potential to provide more capacity in a Contingency situation compared to today's solutions. In addition, it is very likely that the Contingency services can be provided much quicker. Either directly by delegating ATM services provision to another ATSU or by a quick reopening of the sectors supported by the flexibility provided by a Virtual Centre environment.</p>
<p>[NOV-5] D0-Delegation Process Overview -Architecture Y</p>	<p>In the detailed sub-views, a procedure is described for the transfer of responsibility for the provision of ATM services in a volume of airspace between two ATSUs: the delegating ATSU and the receiving ATSU. The procedure is intended to be as generic as possible and to imitate as far as possible the common, everyday procedure used by a sector team when handing over responsibility for a sector(s) at the end of their shift to an incoming sector team. Therefore, the delegation procedure is applicable to all kinds of delegations, e.g. regular delegation at night-time, ATFCM-based delegation providing capacity-on-demand or even contingency cases. The procedure is a sequence of tasks performed by the delegating and receiving ATSU operational staff and, where necessary, technical staff.</p> <p>Notes and assumptions:</p>

	<ol style="list-style-type: none"> 1. The sequence is not meant to be too prescriptive in the order of the tasks but there is necessarily some order and coordination between the actors required. 2. Actions described as being performed by one actor, may be performed by other actors if the capability exists and the need arises, e.g. an ATCO may perform a task identified as being performed by a Supervisor. This may depend on local implementation choices. 3. The procedure assumes that the sector team consists of a Planner and Executive controller, but single ATCO operations are not precluded. 4. In the procedures the Executive ATCO is always described as the leading ATCO, e.g. informing the Supervisor about a certain condition. These tasks could also be performed by the Planner ATCO. To reflect that in the models would overcomplicate them. 5. The delegation procedure describes the necessary steps to delegate one sector from a delegating ATCO team to a receiving ATCO team. Depending on the use case, a set of sectors might be delegated, e.g. in night delegation all sectors of an ATSU would be transferred to another ATSU. This means that several ATCO teams are performing the delegation procedure in parallel. Necessary details will be provided in the use cases as required. 6. The receiving ATCO team could be either idle or they might already be in control of a sector. In the latter case, the delegated sector needs to share a common boundary with the sector already under control by the receiving ATCO team. 7. In some parts of the delegation procedure an ADSP is used in order to illustrate necessary interactions with the ATM system. However, that does not preclude any legacy architecture solutions that do not implement the Virtual Centre concept. 8. The Supervisor is the responsible person taking the decisions in the ops room to delegate or not and to take the necessary preparatory steps. Depending on the local implementation the Supervisor also has the technical means to perform these steps, or he needs to request these steps from an ATSEP. In order not to overcomplicate the diagrams the ATSEP is not shown. <p>The overall delegation procedure is initiated by the delegating ATSU sending a delegation request to the receiving ATSU. If the receiving ATSU accepts the delegation request, a number of preparatory steps must be performed before it is able to take over traffic and control the sector(s) to be delegated. During the 'Enter Preview Mode' phase the CWPs taking over the sector are switched into a 'display-only' Preview Mode where</p>
--	---

	<p>traffic in the sector(s) being delegated is displayed but the receiving ATCOs are inhibited from communicating with the aircraft and from entering tactical commands into the system before responsibility for the sector has been handed over. During the 'Delegation Preparation' phase the receiving ATCO team prepares their CWPs. If a problem occurs, the delegation procedure can be aborted. Otherwise the receiving ATCO team initiates the 'Handover Traffic' phase during which the delegating ATCO team explains the traffic situation and the plan to manage it in the short term to the receiving ATCO team. After this phase is finished, the 'Enter Operational Mode' phase is executed in which the receiving sectors switch to operational mode and the delegating counterpart may switch to shadow mode for safety reasons for a certain period of time. Finally, the 'Exit Preview Mode of delegating ATSU' phase ends the Preview Mode and switches the CWPs in the delegating ATSU to idle.</p> <p>Each of the phases is described in more detail in the sub-views.</p>
<p>[NOV-5] D1-Delegation Request</p>	<p>This is the initial phase of a delegation of ATM services provision between two ATSUs. This phase is triggered by different events related to various use cases, e.g. delegation during night-time. Independent of the triggering mechanism, the delegation procedure is always the same.</p> <p>This phase is initiated by the Supervisor of the delegating ATSU checking with their ATSEPs if the envisaged delegation of ATM services is supported by the system from a technical perspective. The ATSEP is checking the technical status of the system and provides technical advice to the Supervisor. If there are any technical constraints preventing a delegation of ATM services, the Supervisor will terminate the procedure at this stage. If the system is technically able to support the delegation of ATM services, the Supervisor of the delegating ATSU is sending a delegation request for a sector(s) to the receiving ATSU Supervisor.</p> <p>Currently, this would be via a telephone call but could be via a service request in the future.</p> <ul style="list-style-type: none"> • When receiving a delegation request, the operational Supervisor of the receiving ATSU determines from an operational perspective whether a safe delegation can proceed by evaluating the current traffic, staffing and other conditions against a checklist tailored to the local airspace. • If the envisaged delegation is possible from a technical point of view, the operational Supervisor of the receiving ATSU cross-checks with their technical Supervisor if the envisaged delegation is technically possible or not. The technical Supervisor of the

	<p>receiving ATSU may coordinate with the ATSEP of the receiving ATSU if required.</p> <ul style="list-style-type: none"> • The ATSEP of the receiving ATSU checks the technical status of the system and provides technical advice to the technical Supervisor of the receiving ATSU. • Depending on the outcome of the operational and technical evaluation of the delegation request, the operational Supervisor of the receiving ATSU is indicating to the operational Supervisor of the delegating ATSU that the delegation can either proceed, be delayed, or denied. • The delegation request is also denied if the technical check by the technical Supervisor or ATSEP of the receiving ATSU gives a negative result. In that case the delegation request would be denied without performing the check of the operational feasibility. <p>Depending on the answer, the operational Supervisor of the delegating ATSU may either cancel or delay the delegation in case of a negative answer, or on positive answer the delegation is expected to be confirmed to the operational Supervisor of the receiving ATSU.</p> <p>On the delegating ATSU side, the operational Supervisor needs to inform the Executive and the Planner ATCOs that a delegation is going to take place. They are already on duty and are then preparing themselves for the delegation, e.g., by having checklists at hand for the handover of the traffic and are standing-by to be contacted by the receiving ATCO team after they have finished their initial preparation.</p>
<p>[NOV-5] D2-Enter Preview Mode</p>	<p>In the context of delegation of ATM service provision and contingency, the principal purpose of Preview Mode is to display to the receiving ATSU’s controllers the traffic that they will inherit as a result of the delegation. The traffic displayed will include those flights under the control of the delegating sector and traffic of interest to that sector, particularly traffic that will shortly be under the control of that sector. The display of the traffic, in conjunction with a handover briefing from the delegating controllers, enable the receiving controllers to understand the traffic situation and take responsibility for the delegated traffic in a safe and efficient manner.</p> <p>A secondary purpose of Preview Mode is to inhibit the entry of clearances and other instructions. This may be achieved</p> <ul style="list-style-type: none"> • by operational procedures agreed between ATSUs or • by intervention by the system to prevent such inputs or

	<ul style="list-style-type: none"> • by a combination of the two options. <p>Which method is chosen must be agreed by the participating ATSU's and included in the Delegation Agreement to avoid any possibility of misunderstanding.</p> <p>The 'Enter Preview Mode' phase is the start of the preparations on the receiving ATSU side. Figure 23 depicts the process flow of this phase of the delegation procedure. The receiving Supervisor decides the sector configuration to be used to accommodate the delegated sector(s). Depending whether a delegation is done regularly, e.g. a daily night delegation, or less frequently, there might be some tasks necessary to be done. The Supervisor checks if the configuration is ready for activation. If the configuration is not yet ready, the ATSEP performs the necessary steps to prepare the system and checks if the system works properly with the newly activated configuration. This includes an interaction with the ADSP providing data to the receiving ATSU.</p> <p>When the sector configuration has been decided, the Supervisor triggers the switch of the receiving ATSU Executive and Planner CWP's that will receive the delegated sector(s) into Preview Mode via a service request to the involved ADSP. In Preview Mode, the CWP displays the traffic but system inputs that affect the flight data are prohibited. The new mode of the CWP's is distributed back from the ADSP to the CWP's that subsequently change from idle mode to Preview Mode. The Supervisor informs the ATCO team (Executive and Planner) to prepare for the upcoming delegation.</p>
<p>[NOV-5] D3-Delegation Preparation</p>	<p>During this phase the receiving Executive and Planner ATCO's prepare their working positions for the upcoming delegation. This includes selecting the appropriate maps, filters and tools required to manage traffic in the sector(s). In addition, the Voice CWP must be configured so that the A/G frequencies are set for Rx only and G/G connections are established.</p> <p>At the end of the phase both receiving Executive and Planner ATCO's check that their CWP's are ready for the handover of traffic. Only if both positions are correctly prepared the delegation procedure can proceed. If a problem is encountered, the delegation procedure may need to be aborted if it cannot be resolved quickly. If the problem can be fixed in a reasonable time, then the procedure is only delayed and will continue with the 'Exchange Traffic Situation' phase after the problem is solved.</p>
<p>[NOV-5] D4-Exchange Traffic Situation</p>	<p>If the preparation of the receiving ATSU was completed successfully, everything is in place to initiate the handover of traffic from the delegating ATSU to the receiving ATSU to switch the responsibility for providing ATM services in the delegated sector. During this phase the receiving and the</p>

	<p>delegating ATCO team are in direct contact to exchange information about the current traffic situation.</p> <p>The exchange of traffic can start as soon as the receiving ATCO team has finished their preparation and they have called the delegating ATCO team. By watching the traffic situation in preview mode and listening to the sector frequency, the receiving ATCO team tries to determine if the current traffic situation is suitable to start the handover. Nonetheless, the delegating ATCO team may have the need to slightly delay the exchange the traffic, if there are urgent situations that need to be handled beforehand.</p> <p>The communication is established by the receiving Executive and Planner after they have successfully prepared their positions and collectively decided to continue the delegation procedure. They contact their counterpart on the delegating ATSU side. The receiving controllers have the traffic displayed on their CWP's and, after contact is established, they request the tactical information for the flights relevant to the sector (Executive) and the plans for the short-term traffic entering/leaving the sector (Planner) respectively. When both the receiving Executive and Planner controllers are confident that they understand the traffic scenario and are ready to take over the sector, the next phase is entered.</p> <p>This is a very critical phase of the delegation procedure because after the exchange the delegating and the receiving ATCO team need to be fully synchronised. It is essential, that the receiving ATCO team has the full picture of the traffic in the sector to be delegated. All operational intentions and potential conflicts need to be explained by the delegating ATCO team. A systematic approach needs to be applied for this exchange to make sure no flights are forgotten, e.g., explaining the flight from north to south or starting with the most critical ones and finishing with the uncritical flights. In addition to this, all flights shall be read-back and acknowledged by the receiving ATCO team.</p>
<p>[NOV-5] D4b-Abort Delegation</p>	<p>In the event of a problem on the receiving side which cannot be resolved quickly, e.g., unavailability of radio communication or failure of the CWP, the delegation procedure needs to be aborted. Furthermore, there might occur operational situations, such as a sudden emergency call of an aircraft, that require to abort a delegation by the delegating ATSU although the delegation request was positively replied by the receiving ATSU before.</p> <p>Important: a delegation can be aborted at any time before the receiving ATSU has taken control of the delegated airspace. To</p>

	<p>keep the diagrams readable, the abort is only described at a particular phase of the delegation procedure.</p> <p>In the depicted process flow of this phase, either the receiving Executive or Planner ATCO informs their operational Supervisor of the receiving ATSU that a problem has occurred during the preparation of the CWPs. Besides this, a problem may also be detected by the operational Supervisor themselves through the supervision tools available at the operational Supervisor position. The operational Supervisor of the receiving ATSU then consults experts to decide if the problem can be fixed quickly and the delegation can be continued or if the delegation needs to be aborted. This involves the technical Supervisor of the receiving ATSU and their ATSEPs for a detailed technical analysis of the problem.</p> <p>At the technical level, the ATSEPs of the receiving ATSU are responsible to analyse the system and to solve problems if possible. They provide technical advice to the technical Supervisor of the receiving ATSU. In the latter case the operational Supervisor of the receiving ATSU forwards this information about the abort to the operational Supervisor of the delegating ATSU who subsequently informs the ATCO team of the delegating ATSU about the abort of the delegation procedure.</p> <p>In addition to the delegating ATSU the Network Manager needs to be informed about the abort delegation. There might be a regular delegation between two ATSUs, such as a night delegation, that needs to be aborted. To have a full picture of the ATM network in Europe, the NM needs to be informed if a delegation is aborted. In addition to the Network Manager, additional third parties might need to be informed, such as Military, airports, adjacent ATSUs, etc.</p> <p>On the receiving ATSU side, the operational Supervisor requests the switch of the CWPs from the Preview Mode back to the previous mode for the affected sector. This request is processed by the ADSP and redistributed to the CWPs.</p> <p>The procedure ends here. The consequences of aborting the delegation procedure are depending on the use case.</p>
<p>[NOV-5] D5-Enter Operational Mode of Receiving ATSU</p>	<p>After the traffic situation has been exchanged, the CWPs of the receiving ATCO team need to be switched from Preview Mode to operational mode and the CWPs of the delegating ATCO team need to be switched to Preview Mode. In principle, this switch may be triggered by the operational Supervisor of the receiving ATSU or one of the receiving ATCOs, depending on</p>

the local implementation choice. In this phase and in the further description of this phase, the operational Supervisor triggers the switch.

Initially, the receiving Executive ATCO switches the frequency of the sector to Tx/Rx on their VCS and informs their counterpart at the delegating ATSU that control has successfully been taken over. Consequently, the delegating Executive relinquishes the responsibility for the sector and switches the VCS from Tx/Rx to Rx only for the sector to follow the radio communication during Preview Mode. By integrating the ATM system and the VCS, the sector frequencies of the delegated sector could be automatically switched from Rx to Tx/Rx in the receiving ATSU and from Tx/Rx to Rx in the delegating ATSU as soon as they switch from preview mode to operational mode and vice versa.

The receiving Executive ATCO informs the operational Supervisor of the receiving ATSU that the previous phase was successfully completed, and that the receiving ATCO team has taken over control of the sector. The operational Supervisor of the receiving ATSU requests the CWP to be set to operational mode. This request is processed by the ADSP. Since a new set of CWPs will be responsible for a given sector, the operational sector configuration needs to be changed and distributed to all the involved CWPs. By processing this change, system inputs that affect the flight data are enabled at the CWPs of the receiving ATSU while the delegating CWPs enter Preview Mode. For reasons of safety, the delegating CWPs may remain in shadow mode for a while, allowing the delegating ATCOs, that still have the current traffic picture in their minds, to reverse the delegation at short notice if necessary.

Finally, the Network Manager needs to be informed about the delegation between the delegating and receiving ATSU to have the full picture of the European network. In addition to the Network Manager, additional third parties might need to be informed, such as Military, airports, adjacent ATSUs, etc.

As the previous phase, the switch from preview mode to operational mode at the receiving ATSU is a very critical phase of the delegation procedure with respect to safety. It is essential that throughout the procedure exactly one ATSU is responsible for a particular sector. This needs to be made sure by clear communication between the delegating and the receiving ATCO team. The receiving team needs to make clear

	<p>unambiguously when they are ready to take over the airspace. A suitable phraseology might be helpful.</p> <p>Error! Reference source not found. identifies the receiving ATSU as the actor who is initiating the switch from preview mode to operational mode. But this is only one possible option. A concrete implementation of the delegation procedure may also have the delegating ATSU in the leading role for the switch from preview mode to operational mode. A safety assessment of a concrete implementation is required to identify which actor should be in the lead for the particular implementation case. Generally, it is considered safer that the receiving ATSU is explicitly pulling the responsibility for the delegated airspace, instead of being pushed into the responsibility by the delegating ATSU due to the geographical separation of the ATSUs. Again, clear and unambiguous communication between the delegating and receiving ATCO teams is paramount to ensure a safe delegation.</p>
<p>[NOV-5] D6-Exit Preview Mode of Delegating ATSU</p>	<p>The period during which the Preview Mode is maintained in the delegating ATSU for safety reasons is not uniquely specified. A number of local factors will be involved including terms agreed in a LoA or it may be individually decided by the receiving ATCO team.</p> <p>The receiving Executive ATCO informs the receiving Supervisor about ending the Preview Mode of the delegating ATSU. The final decision is made by the receiving Supervisor. The request to end the Preview Mode of the delegating ATSU is processed by the ADSP and distributed to all involved ATSUs. Upon receipt of the updated CWP configuration, the CWPs of the delegating ATCO team are switched to Idle Mode.</p> <p>The procedure ends here.</p> <p>In principle, the end of the Preview Mode can also be triggered by the delegating ATSU. This is not depicted in the view in order not to over-complicate the diagram.</p>

Table 5: Contingency and Delegation Operational Use Cases

System Process	Description
[NSV-4] Arch D - D2-Enter Preview Mode	See 4.1.4.1
[NSV-4] Arch U - D2-Enter Preview Mode	See 4.1.3.1
[NSV-4] Arch U - D5-Enter Operational Mode of Receiving ATSU	See 4.1.3.2
[NSV-4] Arch U - D6-Exit Preview Mode of Delegating ATSU	See 4.1.3.3
[NSV-4] Arch Y - D0-Delegation Process Overview	See 4.1.2.1

[NSV-4] Arch Y - D4b-Abort Delegation	See 4.1.2.2
--	-------------

Table 6: System Processes

3.1.3.2.1 OSED Elementary Delegation Scenarios

The V3 OSED introduces elementary delegation scenarios that operationally describe the different ways of how ATM services can be delegated among two ATSU, without considering the broader operational context; e.g. the reasons why a delegation is initiated.

These elementary delegations have technical dependencies with the different architecture supporting the delegations.

3.1.3.2.1.1 Delegation with static AoR

The key point of delegation with static AoR is that the AoRs of the ATSU are not changed and that the sector which is transferred is not consolidated with another sector of the AoR of the receiving ATSU.

“Y” and “D” architectures are perfectly matching this case where the receiving CWP are just connected to the delegating ADSP by taking profit of the delegating ADSP services.

“U” architecture does not apply to this case due to its nature where the ATSU’s AoRs have to be modified during the delegation and where the delegated sector(s) must be adjacent to the receiving AoR in order to avoid an inefficient management of fragmented AoRs.

3.1.3.2.1.2 Delegation of elementary sector, or partial sector, with dynamic AoR

The key point of delegation of elementary sector (or partial) with dynamic AoR is that the AoRs of the ATSU are adapted according to the delegation. A new boundary is established between the ATSU at which the coordination will take place. This is obviously only performed between two adjacent ATSU that share a common border.

“U” architecture is perfectly designed for this case, but “Y” architecture can also easily execute it.

By nature, “D” architecture does not support the change of AoR because the receiving CWP are just connected to the delegating ADSP that owns the appropriate delegated AoR.

3.1.3.3 Applicable standards and regulations

No standard supporting specifying the Virtual Centre services is defined yet. Conversely, the output of PJ.16-03, PJ.10_93 and PJ.32 are currently used as reference material by the EUROCAE WG-122 for developing a standard in this domain.

3.1.4 Capability Configurations required for the SESAR Solution

[Context] Architecture U - ATS Delegation with 2 ADSPs - Dynamic AoRs	
--	--

CC	Op Env	Capability	Node	Stakeholder
ATC ADSP (PJ.10-93) receiving	En-Route;	ATM Data Provision in support of the Virtual Centre;	Air Traffic Flow and Capacity Management; Airspace Management; Airspace Organisation; Data Service Provision; En-Route/Approach ATS;	Civil ATS En-Route Service Provider; Military ATS En-Route Service Provider;
ATC ADSP (PJ.10-93) delegating	En-Route;	ATM Data Provision in support of the Virtual Centre;	Air Traffic Flow and Capacity Management; Airspace Management; Airspace Organisation; Data Service Provision; En-Route/Approach ATS;	Civil ATS En-Route Service Provider; Military ATS En-Route Service Provider;
Surveillance Infrastructure En-Route (PJ.10-93) receiving	En-Route;			Civil CNS Service Provider; Military CNS Service Provider;
Surveillance Infrastructure En-Route (PJ.10-93) delegating	En-Route;			Civil CNS Service Provider; Military CNS Service Provider;

VC ATSU (PJ.10-93) receiving	En-Route; Terminal Airspace;	Data Centre Service Management;	En-Route/Approach ATS;	Civil ATS En-Route Service Provider;
VC ATSU (PJ.10-93) delegating	En-Route; Terminal Airspace;	Data Centre Service Management;	En-Route/Approach ATS;	Civil ATS En-Route Service Provider;
Voice ADSP receiving	En-Route; Terminal Airspace;	ATM Data Provision in support of the Virtual Centre;	Data Service Provision; En-Route/Approach ATS;	Air Navigation Service Provider;
Voice ADSP delegating	En-Route; Terminal Airspace;	ATM Data Provision in support of the Virtual Centre;	Data Service Provision; En-Route/Approach ATS;	Air Navigation Service Provider;

[Context] Architecture D - ATS Delegation with 2 ADSPs - Static AoRs				
CC	Op Env	Capability	Node	Stakeholder
ATC ADSP (PJ.10-93) receiving	En-Route;	ATM Data Provision in support of the Virtual Centre;	Air Traffic Flow and Capacity Management; Airspace Management; Airspace Organisation; Data Service Provision; En-Route/Approach ATS;	Civil ATS En-Route Service Provider; Military ATS En-Route Service Provider;
ATC ADSP (PJ.10-93) delegating	En-Route;	ATM Data Provision in support of the Virtual Centre;	Air Traffic Flow and Capacity Management; Airspace Management; Airspace Organisation; Data Service Provision; En-Route/Approach ATS;	Civil ATS En-Route Service Provider; Military ATS En-Route Service Provider;
Surveillance Infrastructure En-Route (PJ.10-93) receiving	En-Route;			Civil CNS Service Provider; Military CNS Service Provider;
Surveillance Infrastructure En-Route (PJ.10-93) delegating	En-Route;			Civil CNS Service Provider; Military CNS Service Provider;

VC ATSU (PJ.10-93) receiving	En-Route; Terminal Airspace;	Data Centre Service Management;	En-Route/Approach ATS;	Civil ATS En-Route Service Provider;
VC ATSU (PJ.10-93) delegating	En-Route; Terminal Airspace;	Data Centre Service Management;	En-Route/Approach ATS;	Civil ATS En-Route Service Provider;
Voice ADSP receiving	En-Route; Terminal Airspace;	ATM Data Provision in support of the Virtual Centre;	Data Service Provision; En-Route/Approach ATS;	Air Navigation Service Provider;
Voice ADSP delegating	En-Route; Terminal Airspace;	ATM Data Provision in support of the Virtual Centre;	Data Service Provision; En-Route/Approach ATS;	Air Navigation Service Provider;

[Context] Architecture Y - ATS Delegation with Common ADSP					
CC	Op Env	Capability	Node	Stakeholder	
ATC ADSP (PJ.10-93) common	En-Route;	ATM Data Provision in support of the Virtual Centre;	Air Traffic Flow and Capacity Management; Airspace Management; Airspace Organisation; Data Service Provision; En-Route/Approach ATS;	Civil ATS En-Route Service Provider; Military ATS En-Route Service Provider;	
Surveillance Infrastructure En-Route (PJ.10-93) common	En-Route;			Civil CNS Service Provider; Military CNS Service Provider;	
VC ATSU receiving	En-Route; Terminal Airspace;	Air Traffic Flow Management; Airspace Configuration Management; Airspace Infringement Avoidance; Arrival/Departure Routes Management; Crisis Management; Data Centre Service Management; Mid-Air Collision Avoidance; Separation Provision (airspace); Trajectory Management;	En-Route/Approach ATS;	Civil ATS En-Route Service Provider;	
VC ATSU delegating	En-Route; Terminal Airspace;	Air Traffic Flow Management; Airspace Configuration Management; Airspace Infringement Avoidance; Arrival/Departure Routes Management; Crisis Management; Data Centre Service Management; Mid-Air Collision Avoidance;	En-Route/Approach ATS;	Civil ATS En-Route Service Provider;	

		Separation Provision (airspace); Trajectory Management;		
Voice ADSP common	En-Route; Terminal Airspace;	ATM Data Provision in support of the Virtual Centre;	Data Service Provision; En-Route/Approach ATS;	Air Navigation Service Provider;

Table 7: List of Capability Configuration required for the SESAR Solution

3.2 Changes imposed by the SESAR Solution on the baseline Architecture

The tables below provide the changes automatically provided by MEGA for feeding this section.

3.2.1 Enablers Common to the three Architectures

Enabler	Element type	Element name	Impact	Change
ER APP ATC 193	Management in the VC ATSU of a CWP preview mode during delegation of ATS Provision between ATSUs			
	Function	Modify ATSU Sector Configuration	Update	
	Function	Request Change to OPSUP	Update	
	Function	Request Delegation Abortion	Introduce	
	Function	Request Switch to Operational Mode	Introduce	
	Function	Update Configuration Data	Update	
ER APP ATC 194	Management in the ADSP of a CWP preview mode during delegation of ATS Provision between ATSUs			
	FB	Flight Planning - Lifecycle Management - Data Distribution (PJ.10-93)		
	FB	Operational Supervision Data Management ER/APP ATC (PJ.10-93)		
	FB	Support Functions Data Management ER/APP (PJ.10-93)		

	FB	Trajectory Prediction and Management (PJ.10-93)		
	Function	Compute Sector Sequence Responsibilities	Update	
	Function	Configure Frequency Allocation	Update	
	Function	Configure Sector Mapping	Update	
	Function	Enable/Disable Tactical Commands	Introduce	
	Function	Publish Configuration Data	Update	
	Function	Update ATSU Sector Configuration	Update	

Table 8: Changes on Baseline Architecture Common

3.2.2 Architecture “Y”

ER APP ATC 195	Management in the VC ATSU of Delegation of ATS Provision between ATSUs with Static AoRs			
	FB	Controller Human Machine Interaction Management ER/APP (PJ.10-93)		
	Function	Modify ATSU Sector Configuration	Update	
	Function	Request Allocation of Delegated Sector(s)	Introduce	
	Function	Request Change to OPSUP	Update	
	Function	Request De-allocation of Delegated Sector(s)	Introduce	
	Function	Request Delegation Abortion	Introduce	
	Function	Update Configuration Data	Update	
ER APP ATC 216	Management in the ADSP of Delegation of ATS provision between ATUs with Static AoRs in a Y-Architecture			
	Function	Manage Flight Data Distribution	Update	
	Function	Provide Configuration Data	Update	
	Function	Monitor Service Activity	Update	
	Function	Manage Sector Configuration Subscription	Update	
ER APP ATC 218	Management in the VC ATSU of Delegation of ATS provision between ATUs with Dynamic AoRs in a Y-Architecture			

	Function	Display Allocated Sector Flight Data	Update	
	Function	Modify ATSU Sector Configuration	Update	
	Function	Request Change to OPSUP	Update	
ER APP ATC 209	Management in the ADSP of Delegation of ATS provision between ATUs with Dynamic AoRs in a Y-Architecture			
	Function	Compute Sector Sequence Responsibilities	Update	
	Function	Identification of applicable LoAs	Update	
	Function	Publish Configuration Data	Update	
	Function	Update AoR/AoI	Update	
	Function	Update ATSU Sector Configuration	Update	
SVC-049	Operational Configuration Distribution of Working Position Preview Mode, and Neighbouring ATSU Sector configuration for ATM Service Delegation			
	Service	Operational Configuration Distribution (PJ.10-W2-93)	Update	
SVC-050	Operational Configuration Management of Working Position Preview Mode, and Neighbouring ATSU Sectors for ATM Service Delegation			
	Service	Operational Configuration Management (PJ.10-W2-93)	Update	

Table 9: Changes on Baseline Architecture "Y"

3.2.3 Architecture "D"

ER APP ATC 215	Management in the VC ATSU of Delegation of ATS Provision between ATUs with Static AoRs in a D-Architecture			
	Function	Display Configuration Status	Update	
	Function	Display CWP Status	Update	
	Function	Launch CWP Service Subscriptions	Update	
	Function	Launch Service Subscription	Update	
	Function	Request Configuration Information	Update	
	Function	Subscribe CWP to Service	Update	
ER APP ATC 217	Management in the ADSP of Delegation of ATS provision between ATUs with Static AoRs in a D-Architecture			

	Function	Manage Flight Data Distribution	Update	
	Function	Manage Sector Configuration Subscription	Update	
	Function	Monitor Service Activity	Update	
	Function	Provide Configuration Data	Update	
SVC-049	Operational Configuration Distribution of Working Position Preview Mode, and Neighbouring ATSU Sector configuration for ATM Service Delegation			
	Service	Operational Configuration Distribution (PJ.10-W2-93)	Update	
SVC-050	Operational Configuration Management of Working Position Preview Mode, and Neighbouring ATSU Sectors for ATM Service Delegation			
	Service	Operational Configuration Management (PJ.10-W2-93)	Update	

Table 10: Changes on Baseline Architecture "D"

3.2.4 Architecture "U"

ER APP ATC 196	Management in the VC ATSU of Delegation of ATS provision between ATSUs with Dynamic AoRs for U-Architecture			
	FB	Controller Human Machine Interaction Management ER/APP (PJ.10-93)		
	FB	Operational Supervision HMI ER/APP ATC (PJ.10-93)		
	FB	Support Functions HMI ER/APP (PJ.10-93)		
	Function	Modify ATSU Sector Configuration	Update	
	Function	Request Change to OPSUP	Update	
	Function	Request Delegation Abortion	Introduce	
	Function	Update Configuration Data	Update	
ER APP ATC 197	Management in the ADSP of Delegation of ATS provision between ATSUs with Dynamic AoRs for U-Architecture			
	FB	Coordination and Transfer (PJ.10-93)		

	FB	Flight Planning - Lifecycle Management - Data Distribution (PJ.10-93)		
	FB	Operational Supervision Data Management ER/APP ATC (PJ.10-93)		
	FB	Support Functions Data Management ER/APP (PJ.10-93)		
	Function	Identification of applicable LoAs	Introduce	
	Function	Update AoR/AoI	Introduce	

Table 11: Changes on Baseline Architecture “U”

4 Technical Specifications

4.1 Functional architecture overview

The technical views have been developed in correspondence with the equivalent operational views.

The complete operational process has been described in the OSED considering the “Y” architecture as reference. The principle remains the same for the corresponding technical views, except that all the detailed views D1 to D6 have been combined in a single technical NSV-4 view for the “Y” architecture. Only the abort sequence (D4b) has been maintained in a separated view.

The operational process also provides some specific “D” and “U” architecture views for which differences are interesting to be highlighted. The equivalent technical views are depicted as well in this document.

The table below recaps the matching of the technical views to the operational views:

NOV-5	NSV-4
D0-Delegation Process Overview -Architecture Y	Arch Y - D0-Delegation Process Overview
D1-Delegation Request	Arch Y - D0-Delegation Process Overview
D2-Enter Preview Mode	Arch Y - D0-Delegation Process Overview
D3-Delegation Preparation	Arch Y - D0-Delegation Process Overview
D4-Exchange Traffic Situation	Arch Y - D0-Delegation Process Overview
D4b-Abort Delegation	Arch Y - D4b-Abort Delegation
D5-Enter Operational Mode of Receiving ATSU	Arch Y - D0-Delegation Process Overview
D6-Exit Preview Mode of Delegating ATSU	Arch Y - D0-Delegation Process Overview
Architecture D - D2-Enter Preview Mode	Arch D - D2-Enter Preview Mode
Architecture U - D2-Enter Preview Mode	Arch U - D2-Enter Preview Mode
Architecture U - D5-Enter Operational Mode	Arch U - D5-Enter Operational Mode of Receiving ATSU
Architecture U - D6-Exit Preview Mode of Delegating ATSU	Architecture "U" - D6-Exit Preview Mode of Delegating ATSU
C0-Contingency Procedure Overview - Architecture Y	Overall view, not a technical scope for Solution 93

C1-Degraded Mode/Emergency	Legacy. Not a specific technical scope for Solution 93
C2-Contingency Delegation	Arch Y - D0-Delegation Process Overview
C3-Clear-the-Sky	Legacy. Not specific technical scope of Solution 93
C5-Service Continuity	Legacy. Not specific technical scope of Solution 93

Table 12: Matching of NOV-5 and NSV-4 Views

The table below recaps the system functions created for supporting the solutions, and the Functional Blocks/Roles to which they have been allocated to.

Role	Functional Block	Function
[NSV-4] Setting of Preview Mode with 2 ADSPs and Change of AoRs		
	A/G and G/G Voice Communication HMI (PJ.10-93)	Display Communication Resources;
	A/G Voice Communication (PJ.10-93)	Configure Frequency Allocation; Publish Air/Ground Resources;
ACC/Approach/TMA Supervisor (PJ.10-93)		Modify ATSU Sector Configuration;
	Controller Human Machine Interaction Management ER/APP (PJ.10-93)	Configure Tech and Ops Environment for the Allocated Sector(s); Display Allocated Sector Flight Data;
	Coordination and Transfer (PJ.10-93)	Compute Sector Sequence Responsibilities;
	Flight Planning - Lifecycle Management - Data Distribution (PJ.10-93)	Publish Flight Data;
	G/G Voice Communication (PJ.10-93)	Configure Sector Mapping; Publish Ground/Ground Resources;
	Operational Supervision Data Management ER/APP ATC (PJ.10-93)	Publish Configuration Data; Update ATSU Sector Configuration;

	Operational Supervision HMI ER/APP ATC (PJ.10-93)	Display Configuration Data; Request Change to OPSUP;
	Trajectory Prediction and Management (PJ.10-93)	Generate Trajectory; Identification of applicable LoAs; Update AoR/Aol;
[NSV-4] Setting of Preview Mode with 2 ADSPs and Static AoRs		
	A/G Voice Communication (PJ.10-93)	Configure Frequency Allocation; Publish Air/Ground Resources;
	Flight Planning - Lifecycle Management - Data Distribution (PJ.10-93)	Manage Flight Data Distribution; Manage Flight Data Subscription; Publish Flight Data;
	G/G Voice Communication (PJ.10-93)	Configure Sector Mapping; Publish Ground/Ground Resources;
	Operational Supervision Data Management ER/APP ATC (PJ.10-93)	Manage Sector Configuration Subscription; Publish Configuration Data; Update ATSU Sector Configuration;
[NSV-4] Switch to Preview Mode for Delegating ATSU with 2 ADSPs and Change of AoRs		
	Coordination and Transfer (PJ.10-93)	Compute Sector Sequence Responsibilities;
	Flight Planning - Lifecycle Management - Data Distribution (PJ.10-93)	Publish Flight Data;
	Operational Supervision Data Management ER/APP ATC (PJ.10-93)	Publish Configuration Data; Update ATSU Sector Configuration;
	Trajectory Prediction and Management (PJ.10-93)	Generate Trajectory; Identification of applicable LoAs; Update AoR/Aol;
[NSV-4] Abort Delegation with Common ADSP		

	Controller Human Machine Interaction Management ER/APP (PJ.10-93)	De-allocate Sector; Display Allocated Sector Flight Data; Request Delegation Abortion;
	Controller Human Machine Interaction Management ER/APP (PJ.10-93)	Display Allocated Sector Flight Data; No Impact; Request Delegation Abortion; Switch Sector back to Operational;
	Coordination and Transfer (PJ.10-93)	Compute Sector Sequence Responsibilities;
	Flight Planning - Lifecycle Management - Data Distribution (PJ.10-93)	Publish Flight Data;
	Operational Supervision Data Management ER/APP ATC (PJ.10-93)	Publish Configuration Data; Update ATSU Sector Configuration;
[NSV-4] Service Behaviour of Common ADSP providing Common Services		
	Controller Human Machine Interaction Management ER/APP (PJ.10-93)	Display Flight Plan Data to ATCO; Input Clearance;
	Flight Planning - Lifecycle Management - Data Distribution (PJ.10-93)	Flight Plan Change; Publish Flight Data;
	Operational Supervision Data Management ER/APP ATC (PJ.10-93)	Manage Sector Configuration Subscription; Publish Configuration Data; Update ATSU Sector Configuration;
	Operational Supervision HMI ER/APP ATC (PJ.10-93)	Display Configuration Data; Request Change to OPSUP; Subscribe to Service;
[NSV-4] Service Behaviour of Common ADSP providing Services per ATSU		
	Controller Human Machine Interaction Management ER/APP (PJ.10-93)	Display Flight Plan Data to ATCO; Input Clearance;

	Flight Planning - Lifecycle Management - Data Distribution (PJ.10-93)	Flight Plan Change; Publish Flight Data;
	Operational Supervision Data Management ER/APP ATC (PJ.10-93)	Manage Sector Configuration Subscription; Manage Sector Configuration Subscription; Publish Configuration Data; Publish Configuration Data; Update ATSU Sector Configuration; Update ATSU Sector Configuration;
	Operational Supervision HMI ER/APP ATC (PJ.10-93)	Display Configuration Data; Request Change to OPSUP; Subscribe to Service;
[NSV-4] Switch to Operational Mode with Common ADSP		
	Operational Supervision Data Management ER/APP ATC (PJ.10-93)	Publish Configuration Data; Update ATSU Sector Configuration;
	Trajectory Prediction and Management (PJ.10-93)	Enable/Disable Tactical Commands;

Table 13: New functions required to perform the UC Operational Activities

4.1.1 VC-ADSP Resource Infrastructure view, common to Architectures “Y”, “D “ and “U”

The technical infrastructure connections between the ADSPs and the VC ATSU are the same for all the different architectures that are presented in this TS/IRS document and so, applicable to 4.1.2, 4.1.3 and 4.1.4.

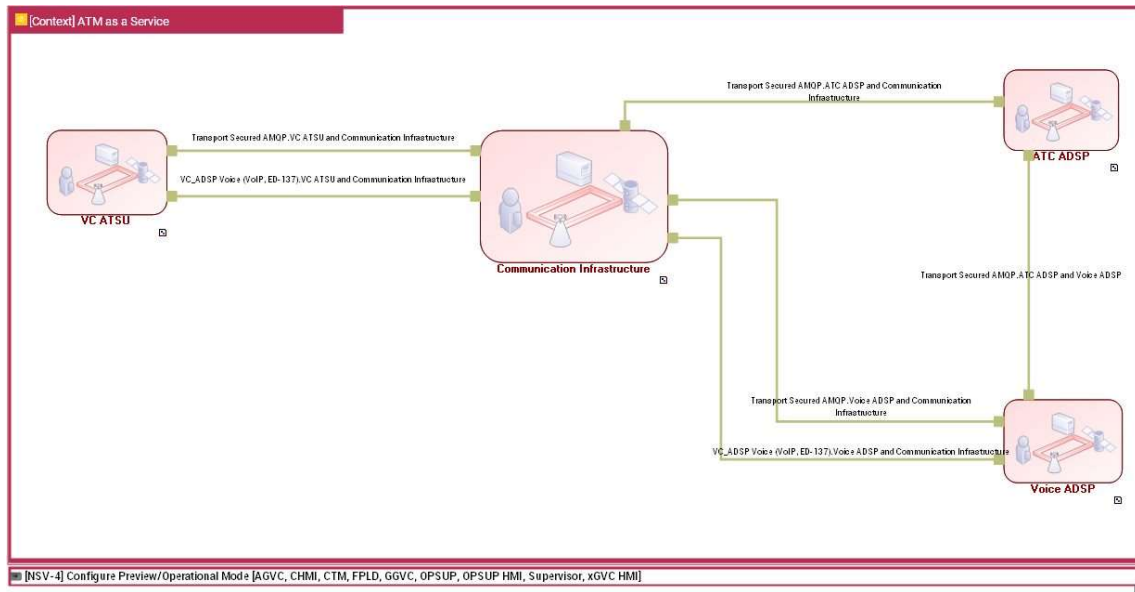

Figure 4: Infrastructure Connectivity Model - Overall ATM as a Service

4.1.2 Architecture "Y" - ATS Delegation with Common ADSP [PJ.10-W2-93A]

This view presents the configuration where the 2 ATSU's are supported by a common ADSP. It is assumed that the Surveillance Infrastructures are shared as well through the ADSP.

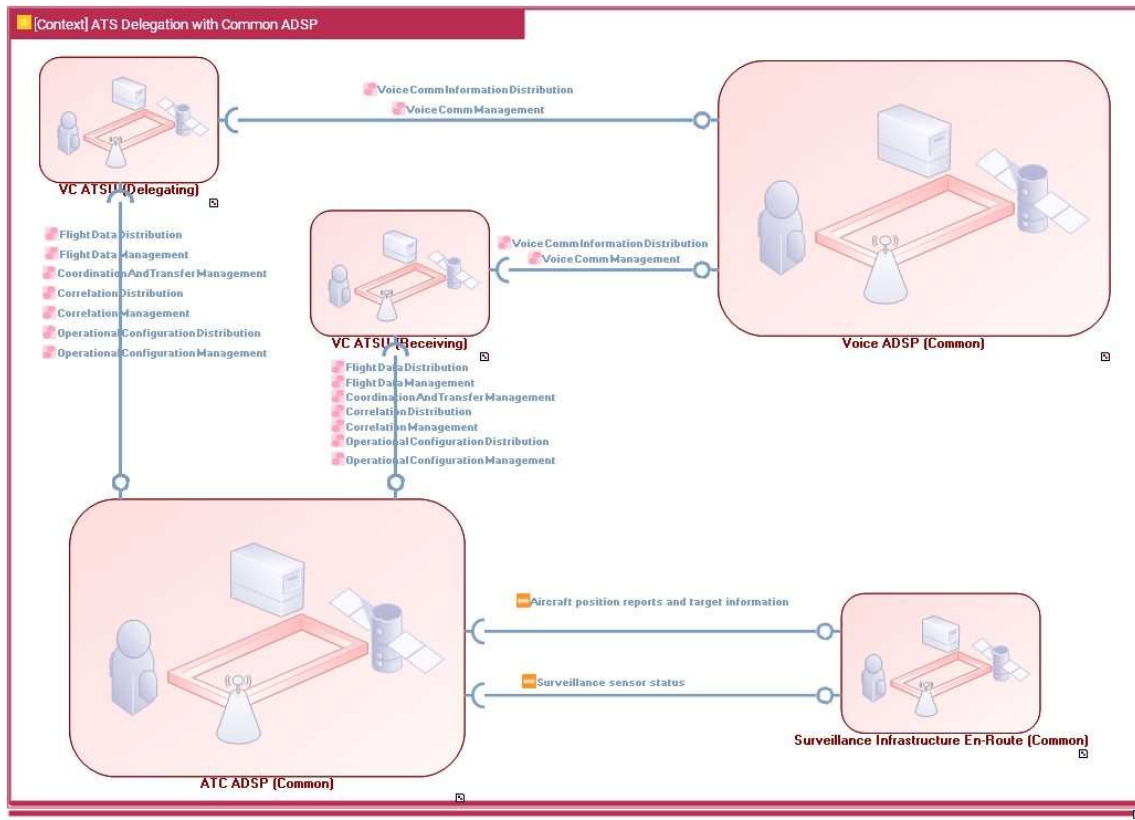

Figure 5: Resource Connectivity Model - Architecture "Y"

4.1.2.1 Architecture "Y" - D0-Delegation Process Overview

This view describes the generic Delegation Procedure that applies for a "Y" architecture, which addresses as well the contingency delegation. The full scenario of a Common ADSP providing Common Services is considered in the view. This corresponds to the "D1", "D2", "D3", "D4", "D5", and "D6" steps of the operational delegation process, recapped in "D0".

In the "Y" architecture, the 2 ATSUs are using the same ADSP services by subscribing to the same physical services. However, the data distribution can be tuned for each ATSU by making use of the service subscription parameters. For example, the provision of the ATSU name may be one of the subscription parameters.

This configuration facilitates the delegation processing by providing shared ATSU sector configurations.

The overall delegation procedure is initiated by the delegating ATSU sending a delegation request to the receiving ATSU:

- the receiving ATSU sets preview mode for the delegated sectors
- the ADSP OPSUPD service distributes the changes to both receiving and delegating ATSUs, where the receiving is set to preview mode for the selected sector while the delegating is kept in operational mode.
- the receiving CWPs display the delegated sector in preview mode, providing the user with a view of the traffic status before applying the delegation.
- when a delegating sector in operational mode modifies a flight, the changes are published to both

receiving and delegating ATSU

- the receiving ATSU switches the preview mode of the delegated sectors to operational mode
- the ADSP OPSUPD service distributes the changes to both receiving and delegating ATSUs, where the symmetric switch from operational mode to preview mode has been automatically triggered
- the new configuration is received, processed and republished to the VCS HMIs by the Voice ADSP
- the receiving CWP's are now on operational mode for delegated sectors while the delegating CWP's display the delegated sector in preview mode, providing the user with a view of the traffic status for safety reasons.
- the delegating ATSU cancels the preview mode of the delegated sectors
- the ADSP OPSUPD service distributes the changes to both receiving and delegating ATSUs, where the receiving is in operational mode for the selected sector while - the delegating is de-assigned from the delegated sectors.

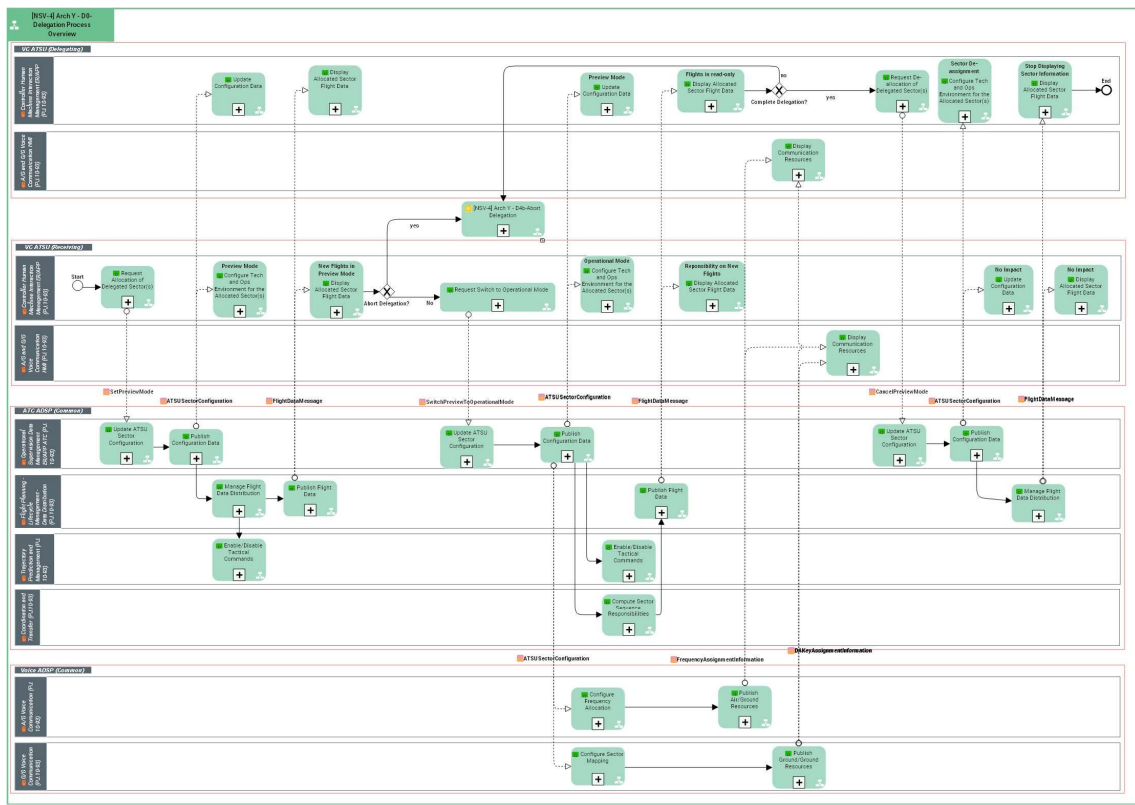

Figure 6: Architecture "Y" - D0-Delegation Process Overview

Function	Description
Compute Sector Sequence Responsibilities	Compute the sectors/units that will either control the flight, or need to be coordinated or informed.
Configure Frequency Allocation	Reconfiguration of frequency assignment(s) of the VCS position(s).

Configure Sector Mapping	Reconfiguration of the sector mapping of the VCS position(s).
Configure Tech and Ops Environment for the Allocated Sector(s)	Initialisation of the HMI with environment and operational data relative to the sector(s) allocated to the position.
Display Allocated Sector Flight Data	After sector reconfiguration and impacts in sector control sequence, update the concerned flights of the position.
Display Communication Resources	Display frequency and sector mapping of the VCS position.
Enable/Disable Tactical Commands	<p>Enable, or disable, the processing of controller commands that have been input when the position is respectively set in operation or in preview mode.</p> <p>This function, when implemented, may as well be directly allocated to the CHMI FB.</p>
Manage Flight Data Distribution	Determine how, and according to which criteria, flight distribution is to be performed for each position/Controller.
Publish Air/Ground Resources	Publication of new frequency assignments to the VCS positions.
Publish Configuration Data	Publishes configuration data to relevant subscribers.
Publish Flight Data	Distribution of Flight Plan Data to the relevant subscribers.
Publish Ground/Ground Resources	Publication of a new sector mapping configuration to the VCS positions.
Request Allocation of Delegated Sector(s)	Following a delegation agreement, request for setting the allocation of the delegated sector on the working position.
Request Switch to Operational Mode	Trigger for switching working position(s) from preview mode to operational mode.
Update ATSU Sector Configuration	Updates the ATSU sector configuration with requested new configuration.
Update Configuration Data	Following reception of a configuration change, analyse the impact on the working position and process the changes if any required.

4.1.2.2 Architecture "Y" - D4b-Abort Delegation

This view illustrates the various functions that are required for aborting a delegation that has been initiated in a "Y" architecture. This corresponds to the "D4b" step of the operational delegation process.

The abort delegation procedure has been considered by the OSED in the situation where a problem is raised and cannot be resolved quickly, thus leading the delegation procedure to be aborted.

The delegation can be aborted either by the receiving ATSU before it switches to operational, or by the delegating ATSU before the delegation is completed. This diagram shows both possibilities:

If the delegation is aborted by the receiving ATSU:

- the receiving ATSU cancels the preview mode
- the ADSP OPSUPD service distributes the changes to both receiving and delegating ATSUs, where both ATSU will be set to the initial sector configuration before the preview was set.
- the receiving CWP de-allocate the delegated sectors
- the delegating CWP switches the sector back to operational.

If the delegation is aborted by the delegating ATSU:

- the delegating ATSU switches the preview mode to operational mode in order to take back the control of the sector
- the ADSP OPSUPD service distributes the changes to both receiving and delegating ATSUs, where the symmetric switch from operational mode to preview mode has been automatically triggered
- the delegating CWP is again on operational mode for delegated sectors
- the receiving CWP de-allocate the delegated sectors

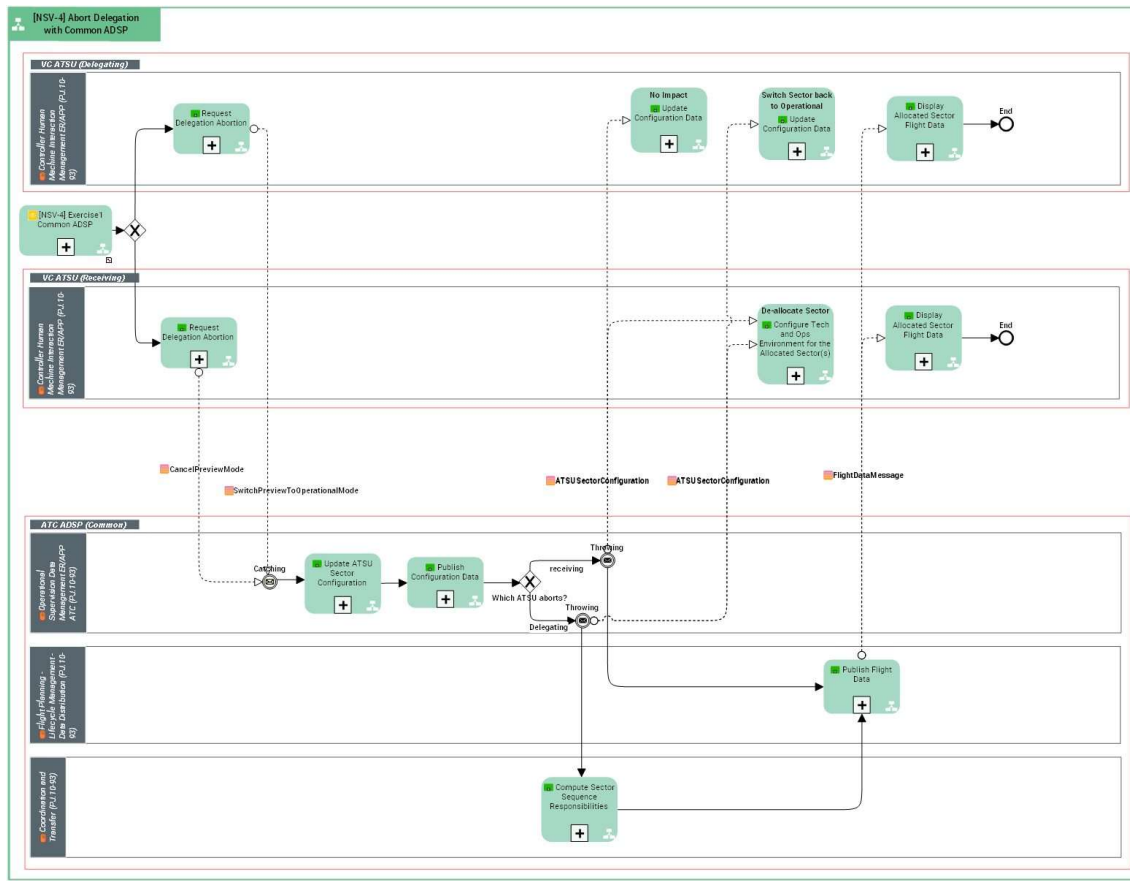

Figure 7: Architecture "Y" - D4b-Abort Delegation

Function	Description
Compute Sector Sequence Responsibilities	Compute the sectors/units that will either control the flight, or need to be coordinated or informed.
Configure Tech and Ops Environment for the Allocated Sector(s)	Initialisation of the HMI with environment and operational data relative to the sector(s) allocated to the position.
Display Allocated Sector Flight Data	After sector reconfiguration and impacts in sector control sequence, update the concerned flights of the position.
Publish Configuration Data	Publishes configuration data to relevant subscribers.
Publish Flight Data	Distribution of Flight Plan Data to the relevant subscribers.

Request Delegation Abortion	Request for triggering the abortion of a delegation process that has been initiated but cannot be completed.
Update ATSU Sector Configuration	Updates the ATSU sector configuration with requested new configuration.
Update Configuration Data	Following reception of a configuration change, analyse the impact on the working position and process the changes if any required.

4.1.3 Architecture "U" - ATS Delegation with 2 ADSPs and Dynamic AoRs [PJ.10-W2-93C]

This view presents the configuration where each of the 2 ATSUs is supported by its own ADSP. The Delegation is performed by moving the whole sector management from one ADSP to the other one. The respective AoRs are modified.

It is assumed that the receiving ADSP receives information from the Surveillance Infrastructure of the delegating ADSP.

In this initial provision, the ADSPs may only achieve data synchronisation for the delegation by using existing interactions.

For V3, PJ.10-93 will analyse further the details of this expected synchronisation and the way to achieve it.

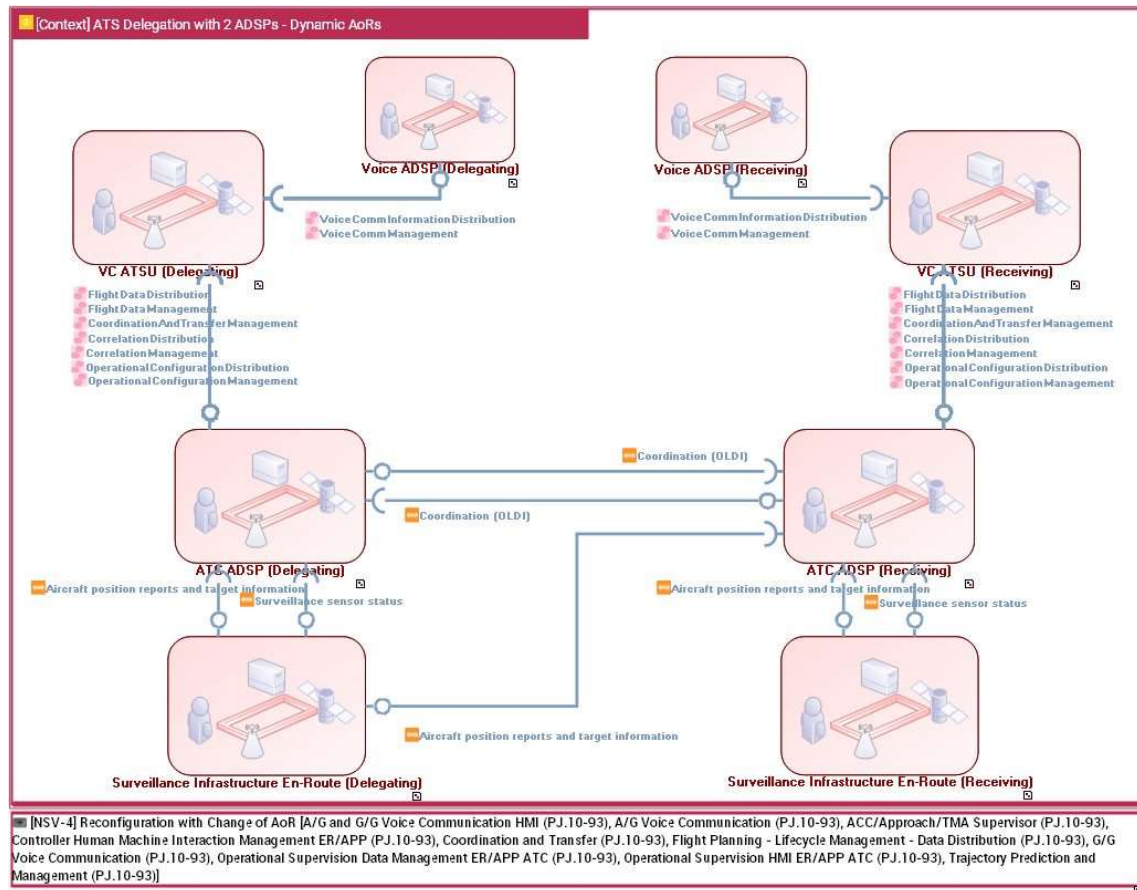

Figure 8: Resource Connectivity Model - Architecture "U"

4.1.3.1 Architecture "U" - D2-Enter Preview Mode

This view illustrates the various functions that are required for setting CWP(s) in preview mode before handling a delegation in a "U" architecture. This corresponds to the "D2" step of the operational delegation process.

In the "U" architecture, the delegation is executed between 2 ADSPs with a portion of the delegating ATSU AoR transferred to the receiving ATSU.

On the delegating side:

- the supervisor of the delegating ATSU changes the configuration on the OPSUP HMI to reduce the AoR as a WhatIf configuration
- the OPSUP HMI sends the new WhatIf configuration to OPSUP in the ADSP
- OPSUP in the ADSP takes into account the configuration and publishes it to the FDP
- the FDP considers the new AoR and corresponding LoAs in order to generate WhatIf trajectories
- the WhatIf situation is used to send the relevant flight information to the receiving ADSP

On the receiving side:

- the supervisor of the receiving ATSU changes the configuration on the OPSUP HMI to extend the AoR as a WhatIf configuration
- the OPSUP HMI sends the new configuration to OPSUP in the ADSP

- OPSUP in the ADSP takes into account the configuration and publishes it
- the new configuration is published to the OPSUP HMI and the CWPs
- the flight information of the flight to be delegated is received from the delegating ADSP. The information is intended to be used for identifying and coordinating the delegated flights
- the new configuration is provided to Trajectory Prediction Management for reassessing the new AoR and the corresponding sectors, determine possible LoA changes and finally provided to Coordination and Transfer for establishing the new sequence of responsibilities of the flights
- the updated flight plans are redistributed as WhatIf with the expected sequence of control in order to display the delegated sector in preview mode

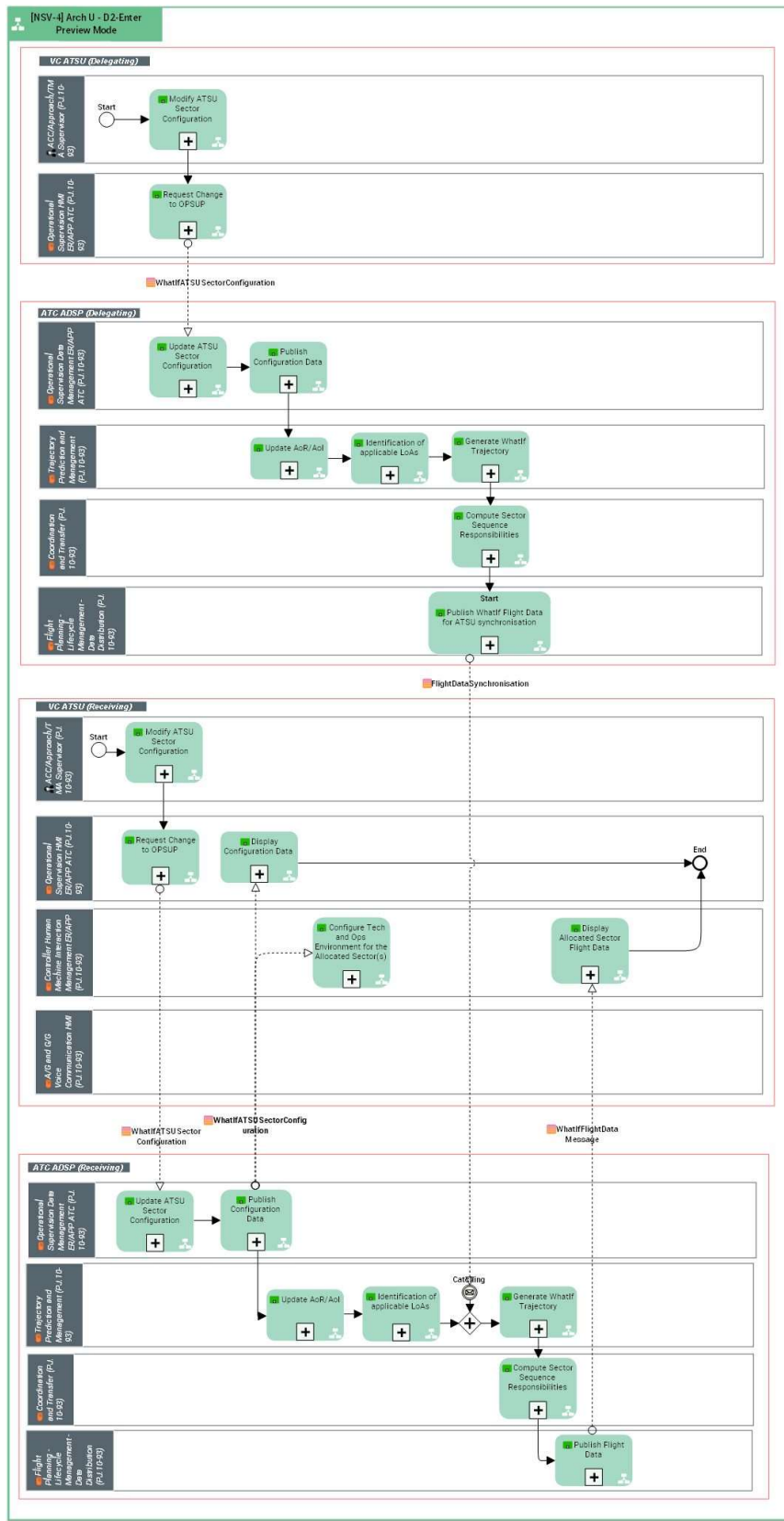

Figure 9: Architecture "U" - D2-Enter Preview Mode

Function	Description
Compute Sector Sequence Responsibilities	Compute the sectors/units that will either control the flight, or need to be coordinated or informed.
Configure Tech and Ops Environment for the Allocated Sector(s)	Initialisation of the HMI with environment and operational data relative to the sector(s) allocated to the position.
Display Allocated Sector Flight Data	After sector reconfiguration and impacts in sector control sequence, update the concerned flights of the position.
Display Configuration Data	Display of configuration data on the HMI.
Generate WhatIf Trajectory	Update trajectory as a WhatIf.
Identification of applicable LoAs	Applicable LoAs are selected according to the active AoR and sector configuration.
Modify ATSU Sector Configuration	Allows sector configuration data of the ATSU to be modified.
Publish Configuration Data	Publishes configuration data to relevant subscribers.
Publish Flight Data	Distribution of Flight Plan Data to the relevant subscribers.
Publish WhatIf Flight Data for ATSU synchronisation	Distribution of required flight information to support display of air situation in preview mode.
Request Change to OPSUP	Triggers the request to OPSUP for taking into account data that have been modified in the HMI.
Update AoR/AoI	Following delegation of sector(s), the AoR and AoIs scopes are reassessed and updated according to the new set of sectors allocated to the ATSU.
Update ATSU Sector Configuration	Updates the ATSU sector configuration with requested new configuration.

4.1.3.2 Architecture "U" - D5-Enter Operational Mode

This view illustrates the various functions that are required for setting CWP(s) in preview mode in the delegating ATSU once the delegation is in operation in the receiving ATSU in a "U" architecture. This

corresponds to the "D5" step of the operational delegation process.

In the "U" architecture, the delegation is executed between 2 ADSPs with a portion of the delegating ATSU AoR transferred to the receiving ATSU.

The view shows the sequencing in the 2 ATSUs that is conducted in parallel.

On the delegating side:

- the supervisor of the delegating ATSU request the WhatIf configuration to become the active one
- the OPSUP HMI sends the request to OPSUP in the ADSP
- OPSUP in the ADSP stops the on-going synchronisation of the flight to be delegated with the delegated sector
- the new configuration is published as a WhatIf configuration to the OPSUP HMI and the CWPs in order to maintain the sector just delegated in preview mode
- the new configuration is provided to Trajectory Prediction Management for reassessing and publishing the WhatIf trajectories
- the updated flight plans are redistributed with the new sequence of control

On the receiving side:

- the supervisor of the receiving ATSU request the WhatIf configuration to become the active one
- the OPSUP HMI sends the request to OPSUP in the ADSP
- OPSUP in the ADSP takes into account the configuration and publishes it
- The tactical commands are enabled on the delegated sector and the WhatIf flight plans are set to current
- MISSING NOTIFICATION END OF PREVIEW TO CWP
- the updated flight plans are redistributed

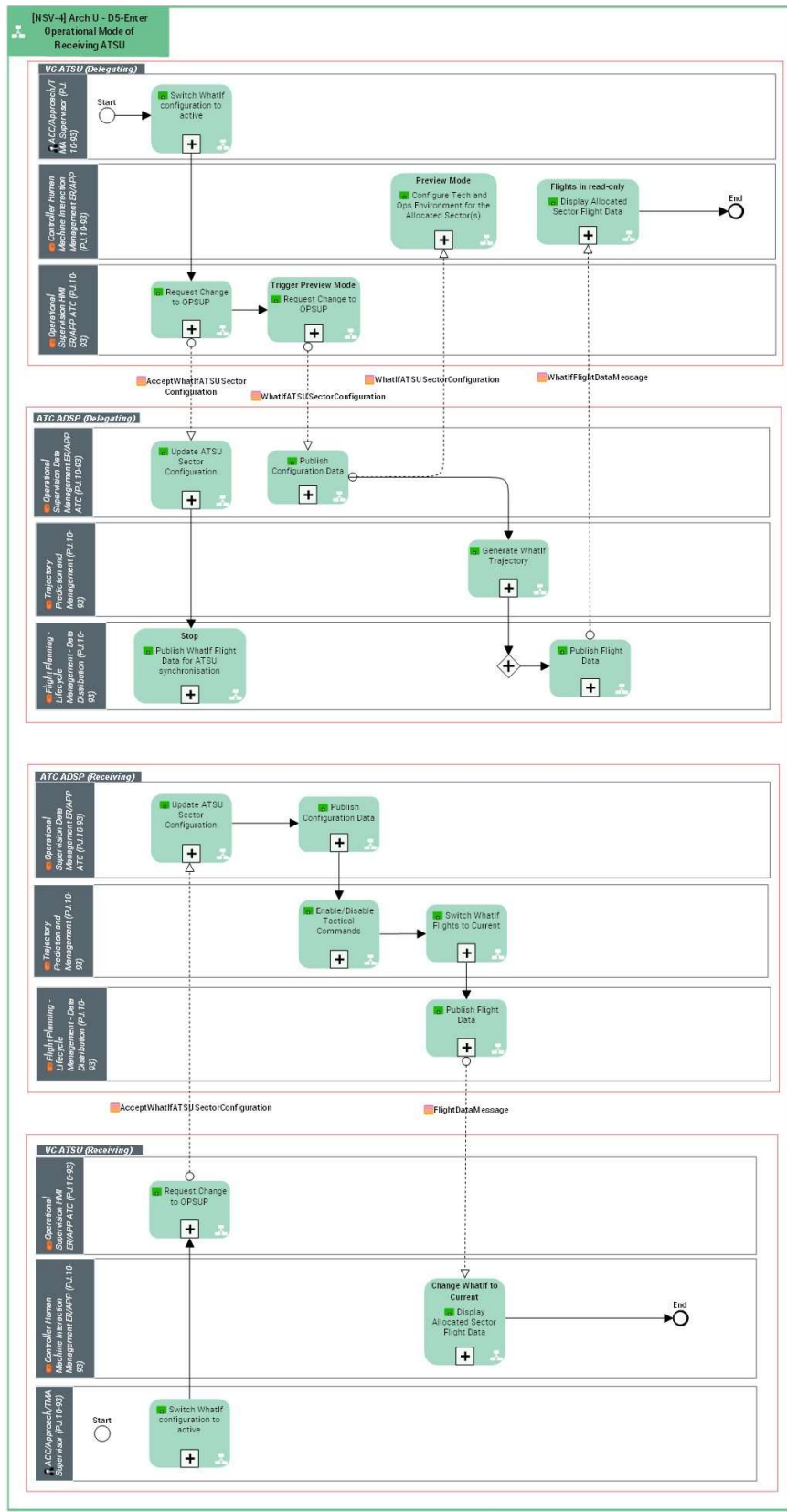

Figure 10: Architecture "U" - D5-Enter Operational Mode

Function	Description
Configure Tech and Ops Environment for the Allocated Sector(s)	Initialisation of the HMI with environment and operational data relative to the sector(s) allocated to the position.
Display Allocated Sector Flight Data	After sector reconfiguration and impacts in sector control sequence, update the concerned flights of the position.
Enable/Disable Tactical Commands	Enable, or disable, the processing of controller commands that have been input when the position is respectively set in operation or in preview mode. This function, when implemented, may as well be directly allocated to the CHMI FB.
Generate WhatIf Trajectory	Update trajectory as a WhatIf.
Publish Configuration Data	Publishes configuration data to relevant subscribers.
Publish Flight Data	Distribution of Flight Plan Data to the relevant subscribers.
Publish WhatIf Flight Data for ATSU synchronisation	Distribution of required flight information to support display of air situation in preview mode.
Request Change to OPSUP	Triggers the request to OPSUP for taking into account data that have been modified in the HMI.
Update ATSU Sector Configuration	Updates the ATSU sector configuration with requested new configuration.

4.1.3.3 Architecture "U" - D6-Exit Preview Mode of Delegating ATSU

This view illustrates the various functions that are required for setting CWP(s) in preview mode in the delegating ATSU once the delegation is in operation in the receiving ATSU in a "U" architecture. This corresponds to the "D6" step of the operational delegation process.

In the "U" architecture, the delegation is executed between 2 ADSPs with a portion of the delegating ATSU AoR transferred to the receiving ATSU.

The view concerns only the delegating ATSU that needs to exit the preview mode once the delegation is operated safely in the receiving ATSU.

- the supervisor of the delegating ATSU request the WhatIf configuration cancellation

- the OPSUP HMI sends the request to OPSUP in the ADSP
- OPSUP in the ADSP stops the configuration in execution
- the new configuration is published and triggers the deallocation of the delegated sector that was still in preview mode

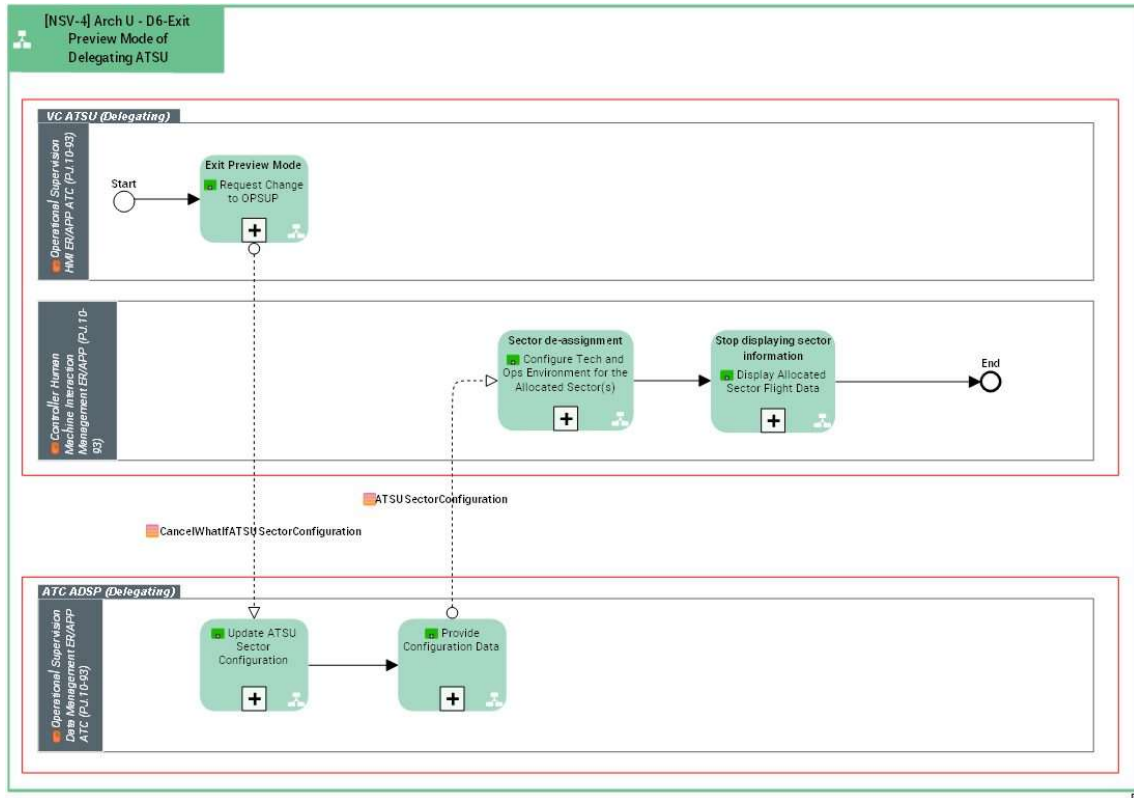

Figure 11: Architecture "U" - D6-Exit Preview Mode of Delegating ATSU

Function	Description
Configure Tech and Ops Environment for the Allocated Sector(s)	Initialisation of the HMI with environment and operational data relative to the sector(s) allocated to the position.
Display Allocated Sector Flight Data	After sector reconfiguration and impacts in sector control sequence, update the concerned flights of the position.
Provide Configuration Data	Report configuration information to a requester.
Request Change to OPSUP	Triggers the request to OPSUP for taking into account data that have been modified in the HMI.

Update ATSU Configuration	Sector	Updates the ATSU sector configuration with requested new configuration.
---------------------------	--------	---

4.1.4 Architecture "D" - ATS Delegation with 2 ADSPs and Static AoRs [PJ.10-W2-93B]

This view presents the configuration where each of the 2 ATSUs is supported by its own ADSP. The delegation is assumed to be performed by a direct connection of CWP's of the receiving ADSP to the delegating ADSP. The respective AoRs are static and remains unchanged with the delegation. Therefore, there is no specific expectation for the ADSPs. However PJ.10-93 will analyse further the details of this configuration in order to check whether some specific needs for the operational configuration would not emerge.

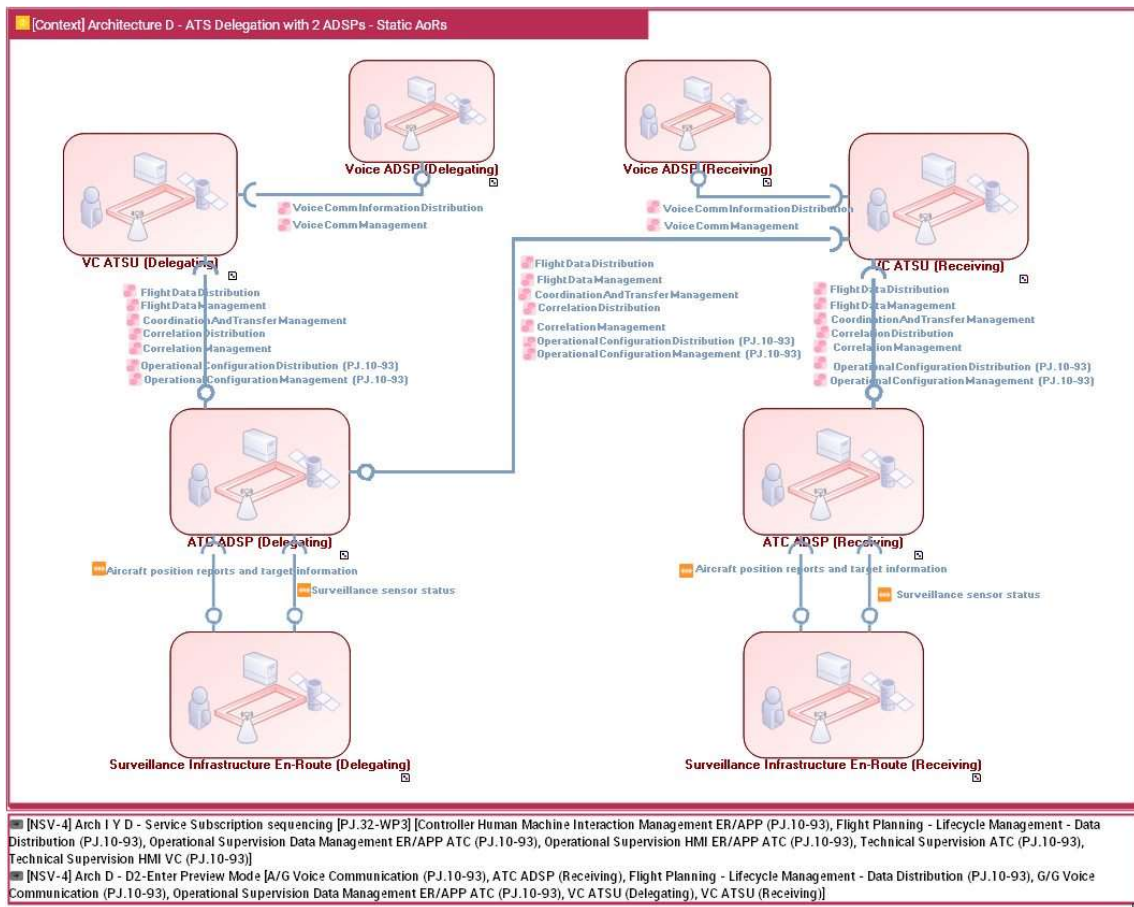

Figure 12: Resource Connectivity Model - Architecture "D"

4.1.4.1 Architecture "D" - D2-Enter Preview Mode

This view illustrates the various functions that are required for setting CWP(s) in preview mode before handling a delegation in a "D" architecture. This corresponds to the "D2" step of the operational delegation process.

In the "D" architecture, the delegation is executed between 2 ADSPs with their respective AoRs remaining unchanged. Actually the delegation is performed by a delegation of control to CWP(s) of the receiving ATSU connected to the delegating ADSP.

The view does not show the receiving Voice ADSP, but the process is expected to be similar to the delegating one.

In this phase of the delegation, there is no specific processing in the delegating ATSU.

- The CWP(s) involved in the delegation unsubscribes from the various services of the receiving ADSP and subscribes to the delegating ADSP services (including Voice services)
- The preview mode is initiated by the delegating ATSU (Supervisor) and the information is published within an ATSU Sector reconfiguration event
- The newly connected receiving CWP(s) performs a flight data repository query on the delegating ADSP for catching up the flight plan situation
- The various Flight Data are distributed to the new CWPs according to their role in the configuration

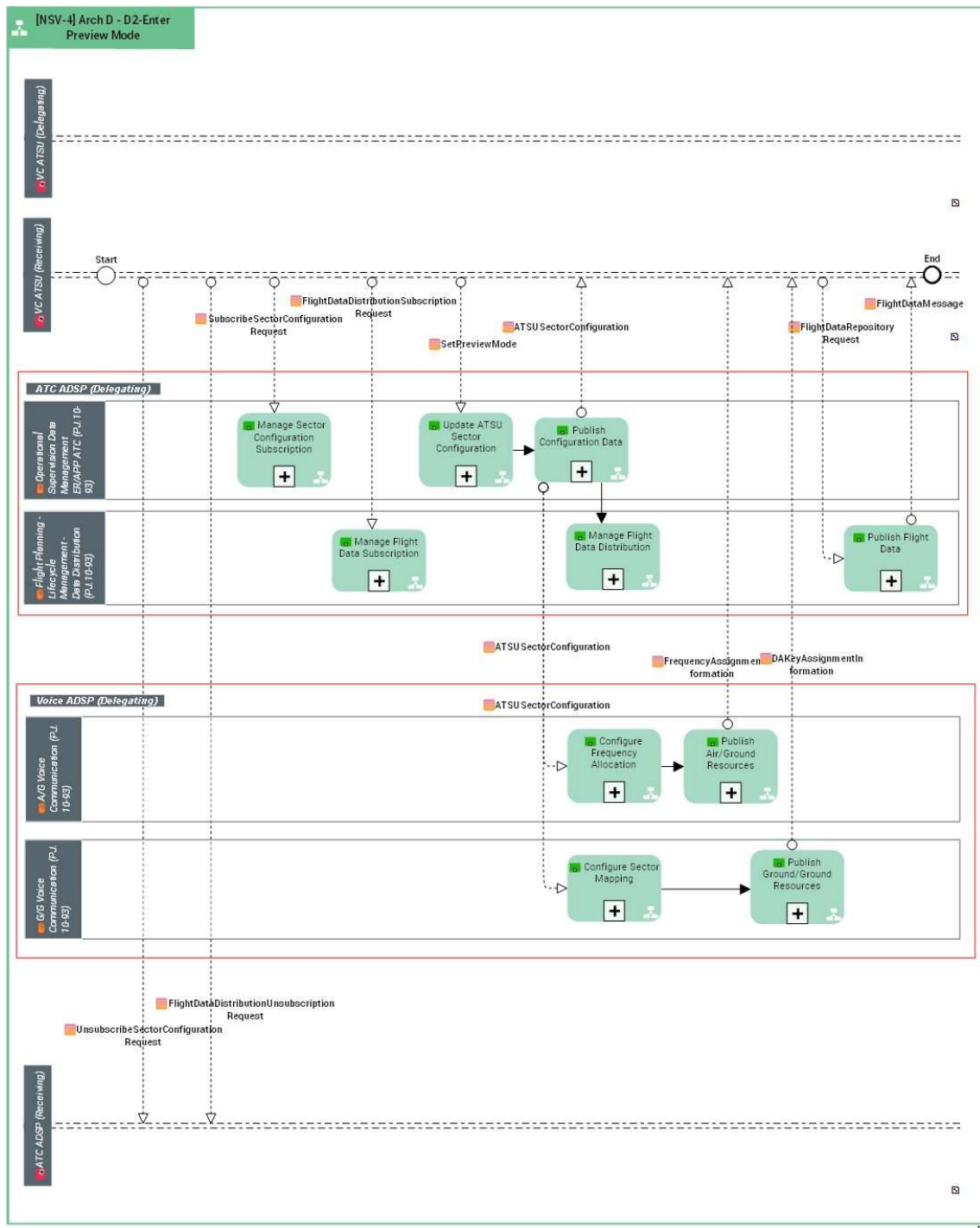

Figure 13: Architecture "D" - D2-Entre Preview Mode

Function	Description
Configure Frequency Allocation	Reconfiguration of frequency assignment(s) of the VCS position(s).

Configure Sector Mapping	Reconfiguration of the sector mapping of the VCS position(s).
Manage Flight Data Distribution	Determine how, and according to which criteria, flight distribution is to be performed for each position/Controller.
Manage Flight Data Subscription	Register and process the details of a subscription to flight data distribution service.
Manage Sector Configuration Subscription	Register and process the details of a subscription to operational configuration distribution service.
Publish Air/Ground Resources	Publication of new frequency assignments to the VCS positions.
Publish Configuration Data	Publishes configuration data to relevant subscribers.
Publish Flight Data	Distribution of Flight Plan Data to the relevant subscribers.
Publish Ground/Ground Resources	Publication of a new sector mapping configuration to the VCS positions.
Update ATSU Sector Configuration	Updates the ATSU sector configuration with requested new configuration.

4.2 Functional and non-Functional Requirements

4.2.1 Functional Requirements

In this section, not all the functional requirements are traced to ATMS requirements. Part of the requirements are directly issued from the OSED requirements, but many others are coming from open thoughts on the way to address exhaustively technical consequences, rather than being directly issued from the operational inputs.

All the PJ.16-03 service requirements applies to Solutions 93A and 93B, but in order to lower document size, only few of the services are (re)introduced in this document:

- Operational Configuration Management services, for introducing new requirements relative to the delegation
- Monitoring Aids service, for setting to <validated> the requirements that have been validated by the validation exercises processed by Solution 93

- Technical Supervision Distribution service, for setting to <validated> the requirements that have been validated by the validation processed run by Solution 93

For the other VC services, the requirements provided in [38] are still relevant.

Some more services have been improved as well by Solution PJ.32-W3-02 in terms of payload contents, i.e. not impacting the requirements. Therefore, they do not appear in this section but are included as annexed SDDs and listed in 4.2.1.5.

4.2.1.1 Technical Management of Delegation

4.2.1.1.1 Some Definitions

“**Distribution of Control**” to an external ATSU (or “**Distributed Control**”): configuration where the working position of the external ATSU receiving the delegation (a.k.a the receiving position) gets data for the delegated sectors from the ADSP of the delegating ATSU. This is performed within the AoRs of the delegating and receiving ATSUs which remain unchanged (i.e. “**Static AoRs**”).

The “**Preview Mode**” is the temporary allocation, for consultation only, of sectors to a CWP for providing the user with a view of the traffic status before applying the delegation; i.e. during the preview phase of the delegation.

A CWP is said in “**Preview Mode - System Managed**” when the consultation mode is ensured by the system inhibiting any request for instruction from this CWP.

A CWP is considered in “**Preview Mode - Procedures Managed**” when the preview mode is not system-managed. In this case, only the operational procedures forbid any request for instruction to be triggered from this CWP (i.e. the system does not perform any specific check for the preview mode)

A sector allocated to a CWP and not in preview mode is said as being in “**Operational Mode**”

A delegation is said as processed with “**Static AoRs**” when the delegating ADSP keeps any delegated sector within its own AoR, but assigns its control to CWPs from the receiving ATSU, which previously subscribed to the delegating ADSP's services.

A delegation is said as processed with “**Dynamic AoRs**” when the control of the delegated sector is transferred from the AoR of the delegating ATSU to the AoR of the receiving ATSU. In this configuration, the receiving CWPs remain connected to the receiving ADSP.

The AoR configuration in the receiving ATSU obtained by a delegation processed with “Dynamic AoRs” is named “**Extended AoR** of the receiving ATSU”.

4.2.1.1.2 Assumptions

It is assumed that a delegated airspace is geographically contiguous to the airspace of the receiving ATSU, and in particular, that if the delegated airspace is intended to be consolidated with sectors of the receiving ATSU, then it has to be more specifically contiguous to this/those sector(s).

4.2.1.1.3 Delegation with Static AoR (Architectures “Y”, “D”)

[REQ]

Identifier	REQ-10-W2.93-TS-DSA.0007
Title	Initial Service Unsubscription
Requirement	As a prerequisite to the Distribution of Control in a D architecture, the receiving working position shall first unsubscribe the ADSP services of the receiving ATSU.
Status	<in progress>
Rationale	<p>Unless a specific need is identified and the use context properly analysed, it is not recommended to merge data of same nature from different ADSPs. This might bring in severe transversal inconsistencies between the received data.</p> <p>The consolidation of sectors belonging to 2 different ATSUs with 2 different ADSPs has not been required. This is expected to be too complex to be managed.</p>
Category	<Functional>

[REQ Trace]

Relationship	Linked Element Type	Identifier
<ALLOCATED_TO>	<SESAR Solution>	PJ.10-W2-93B
<SATISFIES>	< ATMS Requirement>	REQ-PJ.10-W2.93-SPRINTEROP-0014
<ALLOCATED_TO>	<Enabler>	ER APP ATC 215_Management in the VC ATSU of Delegation of ATS Provision between ATUs with Static AoRs in a D-Architecture
<ALLOCATED_TO>	<Functional block>	Controller Human Machine Interaction Management ER/APP (PJ.10-93)
<ALLOCATED_TO>	<System>	VC ATSU ATC (PJ.10-93)
<ALLOCATED_TO>	<FunctionView>	[NSV-4] Arch I Y D - Service Subscription sequencing [PJ.32-WP3)

[REQ]

Identifier	REQ-10-W2.93-TS-DSA.0001
Title	Data Feeding in a D architecture
Requirement	As a prerequisite to the Distribution of Control in a D architecture, the receiving working position shall subscribe to the delegating ADSP services of the delegating ATSU.
Status	<validated>

Rationale	Distribution of Control requires connecting the receiving CWP hosting the delegation to the data flows of the delegating ADSP.
Category	<Functional>

[REQ Trace]

Relationship	Linked Element Type	Identifier
<ALLOCATED_TO>	<SESAR Solution>	PJ.10-W2-93B
<SATISFIES>	< ATMS Requirement>	REQ-PJ.10-W2.93-SPRINTEROP-0014
<ALLOCATED_TO>	<Enabler>	ER APP ATC 215_Management in the VC ATSU of Delegation of ATS Provision between ATUs with Static AoRs in a D-Architecture
<ALLOCATED_TO>	<Functional block>	Controller Human Machine Interaction Management ER/APP (PJ.10-93) Technical Supervision HMI VC (PJ.10-93) Operational Supervision HMI ER/APP ATC (PJ.10-93)
<ALLOCATED_TO>	<System>	VC ATSU ATC (PJ.10-93)

[REQ]

Identifier	REQ-10-W2.93-TS-DSA.0006
Title	Data Feeding in a Y architecture
Requirement	As a prerequisite to the Distribution of Control in a Y architecture, the receiving working position shall unsubscribe the ADSP services and then subscribe again providing the delegating ATSU reference.
Status	<validated>
Rationale	Distribution of Control requires connecting the receiving CWP hosting the delegation to the data flows of the delegating ADSP.
Category	<Functional>

[REQ Trace]

Relationship	Linked Element Type	Identifier
<ALLOCATED_TO>	<SESAR Solution>	PJ.10-W2-93A
<SATISFIES>	< ATMS Requirement>	REQ-PJ.10-W2.93-SPRINTEROP-0014

<ALLOCATED_TO>	<Enabler>	ER APP ATC 195_Management in the VC ATSU of Delegation of ATS Provision between ATSU with Static AoRs for Y-Architecture
<ALLOCATED_TO>	<Functional block>	Controller Human Machine Interaction Management ER/APP (PJ.10-93)
<ALLOCATED_TO>	<System>	VC ATSU ATC (PJ.10-93)
<ALLOCATED_TO>	<FunctionView>	[NSV-4] Arch I Y D - Service Subscription sequencing [PJ.32-WP3]

[REQ]

Identifier	REQ-10-W2.93-TS-DSA.0008
Title	Required ATSU for Service Subscription
Requirement	For subscribing to services within a Y architecture, a working position shall provide the ATSU name in the service subscription parameters (i.e. payload of service operations such as Surveillance, Voice or flight plan data).
Status	<in progress>
Rationale	The data distribution services of an ADSP can feed simultaneously several ATSU. Therefore, the provision of the ATSU at the service subscription is a logical data filter for scoping the distribution, if needed.
Category	<Functional>

[REQ Trace]

Relationship	Linked Element Type	Identifier
<ALLOCATED_TO>	<SESAR Solution>	PJ.10-W2-93A
<SATISFIES>	< ATMS Requirement>	REQ-PJ.10-W2.93-SPRINTEROP-0014
<ALLOCATED_TO>	<Enabler>	ER APP ATC 216_Management in the ADSP of Delegation of ATS provision between ATU with Static AoRs in a Y-Architecture ER APP ATC 195_Management in the VC ATSU of Delegation of ATS Provision between ATSU with Static AoRs for Y-Architecture
<ALLOCATED_TO>	<System>	VC ATSU ATC (PJ.10-93) ADSP ATC (PJ.10-93)

[REQ]

Identifier	REQ-10-W2.93-TS-DSA.0002
Title	Voice Setting in a D architecture
Requirement	For Distributed Control in a D architecture, the receiving working position shall subscribe to the voice communication services of the delegating ATSU and receive the Air/Ground and Ground/Ground resources.
Status	<validated>
Rationale	Distribution of Control requires connecting the receiving CWP hosting the delegation to the voice communication channels of the delegating ADSP.
Category	<Functional>

[REQ Trace]

Relationship	Linked Element Type	Identifier
<ALLOCATED_TO>	<SESAR Solution>	PJ.10-W2-93B
<SATISFIES>	< ATMS Requirement>	REQ-PJ.10-W2.93-SPRINTEROP-0017
<SATISFIES>	< ATMS Requirement>	REQ-PJ.10-W2.93-SPRINTEROP-0028
<SATISFIES>	< ATMS Requirement>	REQ-PJ.10-W2.93-SPRINTEROP-0006
<ALLOCATED_TO>	<Enabler>	ER APP ATC 215_Management in the VC ATSU of Delegation of ATS Provision between ATUs with Static AoRs in a D-Architecture
<ALLOCATED_TO>	<Functional block>	Controller Human Machine Interaction Management ER/APP (PJ.10-93) Technical Supervision Voice HMI VC (PJ.10-93)
<ALLOCATED_TO>	<System>	VC ATSU ATC (PJ.10-93)
<ALLOCATED_TO>	<FunctionView>	[NSV-4] Arch D - D2-Enter Preview Mode

[REQ]

Identifier	REQ-10-W2.93-TS-DSA.0004
Title	Service Subscription
Requirement	For Distributed Control, the receiving CWP shall subscribe to the set of services of the delegating ADSP that has been agreed between the two ATSUs for supporting the service safely in the predefined delegation configuration.
Status	<validated>

Rationale	The set of services provided by a delegating ADSP may be slightly different, or reduced, compared to the ADSP on which receiving CWP's are usually connected. However, a delegation may be considered operable safely with fewer services in use.
Category	<Functional>

[REQ Trace]

Relationship	Linked Element Type	Identifier
<ALLOCATED_TO>	<SESAR Solution>	PJ.10-W2-93B PJ.10-W2-93A
<SATISFIES>	< ATMS Requirement>	REQ-PJ.10-W2.93-SPRINTEROP-0005
<SATISFIES>	< ATMS Requirement>	REQ-PJ.10-W2.93-SPRINTEROP-0026
<ALLOCATED_TO>	<Enabler>	ER APP ATC 215_Management in the VC ATSU of Delegation of ATS Provision between ATUs with Static AoRs in a D-Architecture ER APP ATC 195_Management in the VC ATSU of Delegation of ATS Provision between ATUs with Static AoRs for Y-Architecture
<ALLOCATED_TO>	<Functional block>	Controller Human Machine Interaction Management ER/APP (PJ.10-93)
<ALLOCATED_TO>	<System>	VC ATSU ATC (PJ.10-93)

[REQ]

Identifier	REQ-10-W2.93-TS-DSA.0005
Title	Entry into Operation in a D architecture
Requirement	For Distributed Control in a D architecture, the delegating ADSP managing working positions from a receiving ATSU shall be included in an active configuration as for any physical working position reallocation within the delegating ATSU.
Status	<validated>
Rationale	It is required remote positions from the receiving ATSU appear in the configuration of the delegating ADSP as the positions from the delegating ATSU and that they technically behave exactly on the same way as them, which may not be obvious for subscriptions and initialisation phases.
Category	<Functional>

[REQ Trace]

Relationship	Linked Element Type	Identifier
<ALLOCATED_TO>	<SESAR Solution>	PJ.10-W2-93B
<SATISFIES>	< ATMS Requirement>	REQ-PJ.10-W2.93-SPRINTEROP-0016
<ALLOCATED_TO>	<Enabler>	ER APP ATC 217_Management in the ADSP of Delegation of ATS provision between ATUs with Static AoRs in a D-Architecture
<ALLOCATED_TO>	<System>	ADSP Voice (PJ.10-93) ADSP ATC (PJ.10-93)
<ALLOCATED_TO>	<FunctionView>	[NSV-4) Arch D - D2-Enter Preview Mode

[REQ]

Identifier	REQ-10-W2.93-TS-DSA.0009
Title	Service Subscription before Activation in a Configuration
Requirement	For Distributed Control, the working position shall have subscribed to the ADSP services before being used in an active configuration.
Status	<in progress>
Rationale	A configuration cannot become operationally active without having all its working positions being ready to operate.
Category	<Functional>

[REQ Trace]

Relationship	Linked Element Type	Identifier
<ALLOCATED_TO>	<SESAR Solution>	PJ.10-W2-93B PJ.10-W2-93A
<SATISFIES>	< ATMS Requirement>	REQ-PJ.10-W2.93-SPRINTEROP-0014
<ALLOCATED_TO>	<Enabler>	ER APP ATC 195_Management in the VC ATSU of Delegation of ATS Provision between ATUs with Static AoRs for Y-Architecture ER APP ATC 215_Management in the VC ATSU of Delegation of ATS Provision between ATUs with Static AoRs in a D-Architecture
<ALLOCATED_TO>	<System>	VC ATSU ATC (PJ.10-93)

[REQ]

Identifier	REQ-10-W2.93-TS-DSA.0010
Title	Default Data Publication
Requirement	In preparation of a delegation, AirspaceDataDistribution, FlightDataDistribution and SurveillanceDataDistribution shall publish their data to all their subscribers, whatever they are declared in the active configuration or not.
Status	<in progress>
Rationale	<p>Primary function of services is to provide data distribution to subscribers. Ad-hoc connection of "observers", i.e. not having identified active roles and responsibilities in a configuration, should be allowed. This could be the case, for example, of an adjacent ATSU requiring delivery of AMAN sequences, or an analysis support tool.</p> <p>More specifically, this gives the opportunity to a working position to get the access to data before being included in the configuration with a specific sector allocation, especially for preparing receiving working positions of a delegation.</p>
Category	<Functional>

[REQ Trace]

Relationship	Linked Element Type	Identifier
<ALLOCATED_TO>	<SESAR Solution>	PJ.10-W2-93A PJ.10-W2-93B
<SATISFIES>	< ATMS Requirement>	REQ-PJ.10-W2.93-SPRINTEROP-0014
<ALLOCATED_TO>	<Enabler>	ER APP ATC 194_Management in the ADSP of a CWP preview mode during delegation of ATS Provision between ATSUs
<ALLOCATED_TO>	<Functional block>	Surveillance Flight Planning - Lifecycle Management - Data Distribution (PJ.10-93) Support Functions Data Management ER/APP (PJ.10-93)
<ALLOCATED_TO>	<System>	ADSP ATC (PJ.10-93)

4.2.1.1.4 Delegation with Dynamic AoR (Architecture "U", "Y")

[REQ]

Identifier	REQ-10-W2.93-TS-DDA.0001
------------	--------------------------

Title	Extending AoR
Requirement	For Delegation with Dynamic AoRs, the system shall allow the extension of the AoR of an ATSU for hosting a delegated sector from a neighbouring ATSU.
Status	<validated>
Rationale	Delegation can be achieved by transferring a sector responsibility from the AoR of a system to the AoR of another one, i.e. modifying respectively both AoRs. This will be pre-defined and agreed in advance between stakeholders.
Category	<Functional>

[REQ Trace]

Relationship	Linked Element Type	Identifier
<ALLOCATED_TO>	<SESAR Solution>	PJ.10-W2-93A PJ.10-W2-93C
<SATISFIES>	< ATMS Requirement>	REQ-PJ.10-W2.93-SPRINTEROP-0004
<SATISFIES>	< ATMS Requirement>	REQ-PJ.10-W2.93-SPRINTEROP-0005
<ALLOCATED_TO>	<Enabler>	ER APP ATC 197_Management in the ADSP of Delegation of ATS provision between ATSU with Dynamic AoRs for U-Architecture ER APP ATC 218_Management in the VC ATSU of Delegation of ATS provision between ATUs with Dynamic AoRs in a Y-Architecture ER APP ATC 209_Management in the ADSP of Delegation of ATS provision between ATUs with Dynamic AoRs in a Y-Architecture ER APP ATC 196_Management in the VC ATSU of Delegation of ATS provision between ATSU with Dynamic AoRs for U-Architecture
<ALLOCATED_TO>	<Functional block>	Operational Supervision Data Management ER/APP ATC (PJ.10-93) Operational Supervision HMI ER/APP ATC (PJ.10-93)
<ALLOCATED_TO>	<System>	ADSP ATC (PJ.10-93) ADSP Voice (PJ.10-93) VC ATSU ATC (PJ.10-93)
<ALLOCATED_TO>	<FunctionView>	[NSV-4] Arch U - D2-Enter Preview Mode

[REQ]

Identifier	REQ-10-W2.93-TS-DDA.0002
Title	Reducing AoR in a U architecture
Requirement	After delegating a sector with Dynamic AORs to a neighbouring ATSU in a U architecture, the system shall allow the exclusion of the delegated sector from its AoR.
Status	<validated>
Rationale	Delegation can be achieved by transferring a sector responsibility from the AoR of a system to the AoR of another one, i.e. modifying respectively both AoRs.
Category	<Functional>

[REQ Trace]

Relationship	Linked Element Type	Identifier
<ALLOCATED_TO>	<SESAR Solution>	PJ.10-W2-93C
<SATISFIES>	< ATMS Requirement>	REQ-PJ.10-W2.93-SPRINTEROP-0005
<SATISFIES>	< ATMS Requirement>	REQ-PJ.10-W2.93-SPRINTEROP-0004
<ALLOCATED_TO>	<Enabler>	ER APP ATC 197_Management in the ADSP of Delegation of ATS provision between ATSUs with Dynamic AoRs for U-Architecture ER APP ATC 196_Management in the VC ATSU of Delegation of ATS provision between ATSUs with Dynamic AoRs for U-Architecture
<ALLOCATED_TO>	<Functional block>	Operational Supervision Data Management ER/APP ATC (PJ.10-93) Operational Supervision HMI ER/APP ATC (PJ.10-93)
<ALLOCATED_TO>	<System>	ADSP ATC (PJ.10-93) ADSP Voice (PJ.10-93) VC ATSU ATC (PJ.10-93)
<ALLOCATED_TO>	<FunctionView>	[NSV-4] Arch U - D5-Enter Operational Mode of Receiving ATSU

[REQ]

Identifier	REQ-10-W2.93-TS-DDA.0023
Title	Reducing AoR in a Y architecture
Requirement	After delegating a sector with Dynamic AORs to a neighbouring ATSU in a Y architecture, the system shall move the delegated sector from the delegating AoR to the receiving AoR.
Status	<validated>

Rationale	Delegation can be achieved by transferring a sector responsibility from the AoR of a system to the AoR of another one, i.e. modifying respectively both AoRs.
Category	<Functional>

[REQ Trace]

Relationship	Linked Element Type	Identifier
<ALLOCATED_TO>	<SESAR Solution>	PJ.10-W2-93A
<SATISFIES>	< ATMS Requirement>	REQ-PJ.10-W2.93-SPRINTEROP-0055
<SATISFIES>	< ATMS Requirement>	REQ-PJ.10-W2.93-SPRINTEROP-0054
<ALLOCATED_TO>	<Enabler>	ER APP ATC 209_Management in the ADSP of Delegation of ATS provision between ATUs with Dynamic AoRs in a Y-Architecture ER APP ATC 218_Management in the VC ATSU of Delegation of ATS provision between ATUs with Dynamic AoRs in a Y-Architecture
<ALLOCATED_TO>	<Functional block>	Operational Supervision Data Management ER/APP ATC (PJ.10-93) Operational Supervision HMI ER/APP ATC (PJ.10-93)
<ALLOCATED_TO>	<System>	ADSP Voice (PJ.10-93) ADSP ATC (PJ.10-93) VC ATSU ATC (PJ.10-93)

[REQ]

Identifier	REQ-10-W2.93-TS-DDA.0003
Title	AoR Extension Condition
Requirement	For Delegation with Dynamic AoRs, the system shall allow the whole AoR extension to be allocated to the responsibility of predefined sector(s).
Status	<validated>
Rationale	The AoR subject to delegation must be fully covered by predefined sectors.
Category	<Functional>

[REQ Trace]

Relationship	Linked Element Type	Identifier
<ALLOCATED_TO>	<SESAR Solution>	PJ.10-W2-93A PJ.10-W2-93C
<SATISFIES>	< ATMS Requirement>	REQ-PJ.10-W2.93-SPRINTEROP-0004
<SATISFIES>	< ATMS Requirement>	REQ-PJ.10-W2.93-SPRINTEROP-0005
<ALLOCATED_TO>	<Enabler>	ER APP ATC 218_Management in the VC ATSU of Delegation of ATS provision between ATUs with Dynamic AoRs in a Y-Architecture ER APP ATC 196_Management in the VC ATSU of Delegation of ATS provision between ATUs with Dynamic AoRs for U-Architecture ER APP ATC 197_Management in the ADSP of Delegation of ATS provision between ATUs with Dynamic AoRs for U-Architecture ER APP ATC 209_Management in the ADSP of Delegation of ATS provision between ATUs with Dynamic AoRs in a Y-Architecture
<ALLOCATED_TO>	<Functional block>	Support Functions Data Management ER/APP (PJ.10-93) Support Functions HMI ER/APP (PJ.10-93)
<ALLOCATED_TO>	<System>	ADSP ATC (PJ.10-93) ADSP Voice (PJ.10-93) VC ATSU ATC (PJ.10-93)

[REQ]

Identifier	REQ-10-W2.93-TS-DDA.0004
Title	AoRs Commonality in a U architecture
Requirement	For Delegation with Dynamic AoRs in a U architecture, the system shall ensure that the AoR Extension of a receiving ATSU is defined with the same sector definitions (geographical,names,...) as in the delegating ATSU.
Status	<validated>
Rationale	The delegated airspace shall be defined in the dataset of the receiving ATSU with the same AIRAC information as in the delegating ATSU.
Category	<Functional>

[REQ Trace]

Relationship	Linked Element Type	Identifier
<ALLOCATED_TO>	<SESAR Solution>	PJ.10-W2-93C
<SATISFIES>	< ATMS Requirement>	REQ-PJ.10-W2.93-SPRINTEROP-0004
<SATISFIES>	< ATMS Requirement>	REQ-PJ.10-W2.93-SPRINTEROP-0005
<ALLOCATED_TO>	<Enabler>	ER APP ATC 196_Management in the VC ATSU of Delegation of ATS provision between ATSU with Dynamic AoRs for U-Architecture ER APP ATC 197_Management in the ADSP of Delegation of ATS provision between ATSU with Dynamic AoRs for U-Architecture
<ALLOCATED_TO>	<Functional block>	Support Functions Data Management ER/APP (PJ.10-93) Support Functions HMI ER/APP (PJ.10-93)
<ALLOCATED_TO>	<System>	ADSP ATC (PJ.10-93) VC ATSU ATC (PJ.10-93)

[REQ]

Identifier	REQ-10-W2.93-TS-DDA.0005
Title	Receiving AoR Definition in a U architecture
Requirement	For Delegation with Dynamic AoRs in a U architecture, the system shall ensure that the extended AoR configuration of the receiving ATSU provides the same sector definitions and the same voice communication channels than those of the delegating ATSU.
Status	<validated>
Rationale	The sector(s) to be delegated must be designed in the same way in the respective AoRs of the ATSUs.
Category	<Functional>

[REQ Trace]

Relationship	Linked Element Type	Identifier
<ALLOCATED_TO>	<SESAR Solution>	PJ.10-W2-93C
<SATISFIES>	< ATMS Requirement>	REQ-PJ.10-W2.93-SPRINTEROP-0004
<SATISFIES>	< ATMS Requirement>	REQ-PJ.10-W2.93-SPRINTEROP-0005
<ALLOCATED_TO>	<Enabler>	ER APP ATC 196_Management in the VC ATSU of Delegation of ATS provision between ATSU with Dynamic AoRs for U-Architecture

		ER APP ATC 197_Management in the ADSP of Delegation of ATS provision between ATSUUs with Dynamic AoRs for U-Architecture
<ALLOCATED_TO>	<Functional block>	Support Functions Data Management ER/APP (PJ.10-93) Support Functions HMI ER/APP (PJ.10-93)
<ALLOCATED_TO>	<System>	ADSP Voice (PJ.10-93) VC ATSU ATC (PJ.10-93)

[REQ]

Identifier	REQ-10-W2.93-TS-DDA.0006
Title	Configuration with external Sectors
Requirement	For Delegation with Dynamic AoRs, the system shall allow the allocation of sector(s) from a delegating ATSU to a working position of a receiving ATSU.
Status	<validated>
Rationale	The extension of the AoR is implicitly performed by including new sectors, which in the case of a delegation are expected to come from the neighbouring ATSUUs.
Category	<Functional>

[REQ Trace]

Relationship	Linked Element Type	Identifier
<ALLOCATED_TO>	<SESAR Solution>	PJ.10-W2-93C PJ.10-W2-93A
<SATISFIES>	< ATMS Requirement>	REQ-PJ.10-W2.93-SPRINTEROP-0006
<ALLOCATED_TO>	<Enabler>	ER APP ATC 197_Management in the ADSP of Delegation of ATS provision between ATSUUs with Dynamic AoRs for U-Architecture ER APP ATC 218_Management in the VC ATSU of Delegation of ATS provision between ATUUs with Dynamic AoRs in a Y-Architecture ER APP ATC 196_Management in the VC ATSU of Delegation of ATS provision between ATSUUs with Dynamic AoRs for U-Architecture ER APP ATC 209_Management in the ADSP of Delegation of ATS provision between ATUUs with Dynamic AoRs in a Y-Architecture

<ALLOCATED_TO>	<Functional block>	Operational Supervision Data Management ER/APP ATC (PJ.10-93) Operational Supervision HMI ER/APP ATC (PJ.10-93)
<ALLOCATED_TO>	<System>	ADSP ATC (PJ.10-93) VC ATSU ATC (PJ.10-93)
<ALLOCATED_TO>	<FunctionView>	[NSV-4) Arch U - D2-Enter Preview Mode

[REQ]

Identifier	REQ-10-W2.93-TS-DDA.0007
Title	Coordination Conditions
Requirement	For delegation with dynamic AoRs, the system shall allow the definition of internal coordination conditions within the extended AoR of the receiving ATSU that are specific to the local ATSU or to the delegating ATSU.
Status	<validated>
Rationale	LoAs may be changed once the sector is handled by another ATSU.
Category	<Functional>

[REQ Trace]

Relationship	Linked Element Type	Identifier
<ALLOCATED_TO>	<SESAR Solution>	PJ.10-W2-93A PJ.10-W2-93C
<SATISFIES>	< ATMS Requirement>	REQ-PJ.10-W2.93-SPRINTEROP-0002
<ALLOCATED_TO>	<Enabler>	ER APP ATC 209_Management in the ADSP of Delegation of ATS provision between ATUs with Dynamic AoRs in a Y-Architecture ER APP ATC 197_Management in the ADSP of Delegation of ATS provision between ATSUs with Dynamic AoRs for U-Architecture
<ALLOCATED_TO>	<Functional block>	Support Functions Data Management ER/APP (PJ.10-93) Operational Supervision HMI ER/APP ATC (PJ.10-93)
<ALLOCATED_TO>	<System>	ADSP ATC (PJ.10-93) VC ATSU ATC (PJ.10-93)

<ALLOCATED_TO>	<FunctionView>	[NSV-4) Arch U - D2-Enter Preview Mode
----------------	----------------	--

[REQ]

Identifier	REQ-10-W2.93-TS-DDA.0008
Title	LoAs
Requirement	For Delegation with Dynamic AoRs, the system shall allow the LoAs used by the delegated sectors to be different, depending in which ATSU they are allocated, including the LoAs concerning other third neighbouring ATSUs of the extended AoR.
Status	<in progress>
Rationale	LoAs may be changed once the sector is handled by another ATSU.
Category	<Functional>

[REQ Trace]

Relationship	Linked Element Type	Identifier
<ALLOCATED_TO>	<SESAR Solution>	PJ.10-W2-93A PJ.10-W2-93C
<SATISFIES>	< ATMS Requirement>	REQ-PJ.10-W2.93-SPRINTEROP-0002
<SATISFIES>	< ATMS Requirement>	REQ-PJ.10-W2.93-SPRINTEROP-0003
<ALLOCATED_TO>	<Enabler>	ER APP ATC 197_Management in the ADSP of Delegation of ATS provision between ATSUs with Dynamic AoRs for U-Architecture ER APP ATC 196_Management in the VC ATSU of Delegation of ATS provision between ATSUs with Dynamic AoRs for U-Architecture ER APP ATC 218_Management in the VC ATSU of Delegation of ATS provision between ATUs with Dynamic AoRs in a Y-Architecture ER APP ATC 209_Management in the ADSP of Delegation of ATS provision between ATUs with Dynamic AoRs in a Y-Architecture
<ALLOCATED_TO>	<Functional block>	Support Functions Data Management ER/APP (PJ.10-93) Support Functions HMI ER/APP (PJ.10-93)
<ALLOCATED_TO>	<System>	ADSP ATC (PJ.10-93) VC ATSU ATC (PJ.10-93)
<ALLOCATED_TO>	<FunctionView>	[NSV-4) Arch U - D2-Enter Preview Mode

[REQ]

Identifier	REQ-10-W2.93-TS-DDA.0009
Title	AoR Activation
Requirement	For Delegation with Dynamic AoRs, the system shall allow the sectors of the extended AoR of the receiving ATSU to be initiated in preview mode when the extended AoR is activated.
Status	<validated>
Rationale	A receiving ATCO team needs to have access to sector data before handling the responsibility, but setting the specific preview mode is not mandatory as it may remain procedural.
Category	<Functional>

[REQ Trace]

Relationship	Linked Element Type	Identifier
<ALLOCATED_TO>	<SESAR Solution>	PJ.10-W2-93C PJ.10-W2-93A
<SATISFIES>	< ATMS Requirement>	REQ-PJ.10-W2.93-SPRINTEROP-0014
<ALLOCATED_TO>	<Enabler>	ER APP ATC 209_Management in the ADSP of Delegation of ATS provision between ATUs with Dynamic AoRs in a Y-Architecture ER APP ATC 197_Management in the ADSP of Delegation of ATS provision between ATSU's with Dynamic AoRs for U-Architecture
<ALLOCATED_TO>	<Functional block>	Operational Supervision Data Management ER/APP ATC (PJ.10-93)
<ALLOCATED_TO>	<System>	ADSP ATC (PJ.10-93) ADSP Voice (PJ.10-93)
<ALLOCATED_TO>	<FunctionView>	[NSV-4) Arch U - D2-Enter Preview Mode

[REQ]

Identifier	REQ-10-W2.93-TS-DDA.0011
Title	AoR Reduction in a U architecture
Requirement	For Delegation with Dynamic AoRs in a U architecture, the system shall reduce the AoR in the delegating ATSU by deallocating sector(s) from their working position(s).
Status	<validated>

Rationale	AoR is the implicit result of the collection of sectors it includes. Therefore removing sectors from the configuration de facto reduce the AoR.
Category	<Functional>

[REQ Trace]

Relationship	Linked Element Type	Identifier
<ALLOCATED_TO>	<SESAR Solution>	PJ.10-W2-93C
<SATISFIES>	< ATMS Requirement>	REQ-PJ.10-W2.93-SPRINTEROP-0004
<SATISFIES>	< ATMS Requirement>	REQ-PJ.10-W2.93-SPRINTEROP-0005
<ALLOCATED_TO>	<Enabler>	ER APP ATC 196_Management in the VC ATSU of Delegation of ATS provision between ATSU's with Dynamic AoRs for U-Architecture ER APP ATC 197_Management in the ADSP of Delegation of ATS provision between ATSU's with Dynamic AoRs for U-Architecture
<ALLOCATED_TO>	<Functional block>	Operational Supervision HMI ER/APP ATC (PJ.10-93) Operational Supervision Data Management ER/APP ATC (PJ.10-93)
<ALLOCATED_TO>	<System>	VC ATSU ATC (PJ.10-93) ADSP ATC (PJ.10-93)
<ALLOCATED_TO>	<FunctionView>	[NSV-4) Arch U - D6-Exit Preview Mode of Delegating ATSU

[REQ]

Identifier	REQ-10-W2.93-TS-DDA.0012
Title	Additional Means in a U architecture
Requirement	For Delegation with Dynamic AoRs in a U architecture, the system shall have proper access to the appropriate following technical infrastructures for supporting operations in the extended AoR of the receiving ATSU: <ul style="list-style-type: none"> • Surveillance • Weather • Datalink
Status	<in progress>

Rationale	An AoR can be extended only if it has access to data provided by the corresponding geographical infrastructure.
Category	<Functional>

[REQ Trace]

Relationship	Linked Element Type	Identifier
<ALLOCATED_TO>	<SESAR Solution>	PJ.10-W2-93C
<SATISFIES>	< ATMS Requirement>	REQ-PJ.10-W2.93-SPRINTEROP-0014
<ALLOCATED_TO>	<Enabler>	ER APP ATC 197_Management in the ADSP of Delegation of ATS provision between ATSUs with Dynamic AoRs for U-Architecture
<ALLOCATED_TO>	<System>	ADSP ATC (PJ.10-93)

[REQ]

Identifier	REQ-10-W2.93-TS-DDA.0013
Title	Initial Feeding
Requirement	As a prerequisite to Delegation with Dynamic AoRs in a U architecture, the system shall provide the specific up-to-date information of the delegated sectors to the receiving working positions allocated with extended AoR sectors in the receiving ATSU.
Status	<validated>
Rationale	Delegation can be processed only if the receiving ATCOs have a clear picture of the situation for which they are taking the responsibility.
Category	<Functional>

[REQ Trace]

Relationship	Linked Element Type	Identifier
<ALLOCATED_TO>	<SESAR Solution>	PJ.10-W2-93C
<SATISFIES>	< ATMS Requirement>	REQ-PJ.10-W2.93-SPRINTEROP-0014
<ALLOCATED_TO>	<Enabler>	ER APP ATC 196_Management in the VC ATSU of Delegation of ATS provision between ATSUs with Dynamic AoRs for U-Architecture ER APP ATC 197_Management in the ADSP of Delegation of ATS provision between ATSUs with Dynamic AoRs for U-Architecture

<ALLOCATED_TO>	<Functional block>	Controller Human Machine Interaction Management ER/APP (PJ.10-93)
<ALLOCATED_TO>	<System>	ADSP ATC (PJ.10-93) VC ATSU ATC (PJ.10-93)

[REQ]

Identifier	REQ-10-W2.93-TS-DDA.0014
Title	Expected Information in a U architecture
Requirement	<p>For Delegation with Dynamic AoRs in a U architecture, the ADSP transferring a part of its AoR to another ADSP shall provide the receiving ATSU with the latest expected flight information, which could be local to the system of the delegating ATSU:</p> <ul style="list-style-type: none"> • the coordination status of the flight • the current coordinated data • the current route • the latest input instructions
Status	<in progress>
Rationale	The scope of previously shared information may widely vary; e.g. whether you are in FO environment or not.
Category	<Functional>

[REQ Trace]

Relationship	Linked Element Type	Identifier
<ALLOCATED_TO>	<SESAR Solution>	PJ.10-W2-93C
<SATISFIES>	< ATMS Requirement>	REQ-PJ.10-W2.93-SPRINTEROP-0014
<SATISFIES>	< ATMS Requirement>	REQ-PJ.10-W2.93-SPRINTEROP-SYS.0001
<SATISFIES>	< ATMS Requirement>	REQ-PJ.10-W2.93-SPRINTEROP-SYS.0003
<ALLOCATED_TO>	<Enabler>	ER APP ATC 197_Management in the ADSP of Delegation of ATS provision between ATSUs with Dynamic AoRs for U-Architecture
<ALLOCATED_TO>	<Functional block>	Flight Planning - Lifecycle Management - Data Distribution (PJ.10-93)
<ALLOCATED_TO>	<System>	ADSP ATC (PJ.10-93)

[REQ]

Identifier	REQ-10-W2.93-TS-DDA.0015
Title	System or Procedure Transfer in a U architecture
Requirement	For Delegation with Dynamic AoRs in a U architecture, the triggering of the transfer of responsibility for a sector moving from an AoR to another one shall be supported either by the systems or by procedures.
Status	<validated>
Rationale	A transfer may be executed either with system assistance or just by voice.
Category	<Functional>

[REQ Trace]

Relationship	Linked Element Type	Identifier
<ALLOCATED_TO>	<SESAR Solution>	PJ.10-W2-93C
<SATISFIES>	< ATMS Requirement>	REQ-PJ.10-W2.93-SPRINTEROP-0015
<SATISFIES>	< ATMS Requirement>	REQ-PJ.10-W2.93-SPRINTEROP-0065
<ALLOCATED_TO>	<Enabler>	ER APP ATC 196_Management in the VC ATSU of Delegation of ATS provision between ATSU with Dynamic AoRs for U-Architecture ER APP ATC 197_Management in the ADSP of Delegation of ATS provision between ATSU with Dynamic AoRs for U-Architecture
<ALLOCATED_TO>	<Functional block>	Operational Supervision HMI ER/APP ATC (PJ.10-93) Operational Supervision Data Management ER/APP ATC (PJ.10-93)
<ALLOCATED_TO>	<System>	VC ATSU ATC (PJ.10-93) ADSP ATC (PJ.10-93)

[REQ]

Identifier	REQ-10-W2.93-TS-DDA.0016
Title	Supervision Involvement
Requirement	Whatever the way the transfer of responsibility is performed for Delegation with Dynamic AoRs in a U architecture, both ADSPs shall be eventually informed that the transfer is effective by a supervision input.
Status	<in progress>
Rationale	Once the transfer is effective, both systems need to be updated on the respective status of the flights in each system.

Category	<Functional>
----------	--------------

[REQ Trace]

Relationship	Linked Element Type	Identifier
<ALLOCATED_TO>	<SESAR Solution>	PJ.10-W2-93C
<SATISFIES>	< ATMS Requirement>	REQ-PJ.10-W2-93-SPRINTEROP-0026
<SATISFIES>	< ATMS Requirement>	REQ-PJ.10-W2-93-SPRINTEROP-0027
<ALLOCATED_TO>	<Enabler>	ER APP ATC 197_Management in the ADSP of Delegation of ATS provision between ATSU with Dynamic AoRs for U-Architecture ER APP ATC 196_Management in the VC ATSU of Delegation of ATS provision between ATSU with Dynamic AoRs for U-Architecture
<ALLOCATED_TO>	<Functional block>	Operational Supervision HMI ER/APP ATC (PJ.10-93) Operational Supervision Data Management ER/APP ATC (PJ.10-93)
<ALLOCATED_TO>	<System>	VC ATSU ATC (PJ.10-93) ADSP Voice (PJ.10-93) ADSP ATC (PJ.10-93)

[REQ]

Identifier	REQ-10-W2.93-TS-DDA.0017
Title	OLDI Management in a U architecture
Requirement	For Delegation with Dynamic AoRs in a U architecture, and when the ADSPs are informed of the transfer being effective, they shall respectively process, or stop processing, the OLDI management of the transferred sector(s).
Status	<validated>
Rationale	Once the transfer is effective, the whole sector OLDI activity of each system must respectively be updated to stop and start old/new connections. This implication of stopping and starting OLDI messages and how OLDI messages are processed will need to be considered further.
Category	<Functional>

[REQ Trace]

Relationship	Linked Element Type	Identifier
<ALLOCATED_TO>	<SESAR Solution>	PJ.10-W2-93C
<SATISFIES>	< ATMS Requirement>	REQ-PJ.10-W2.93-SPRINTEROP-0026
<SATISFIES>	< ATMS Requirement>	REQ-PJ.10-W2.93-SPRINTEROP-0027
<ALLOCATED_TO>	<Enabler>	ER APP ATC 197_Management in the ADSP of Delegation of ATS provision between ATSU with Dynamic AoRs for U-Architecture
<ALLOCATED_TO>	<Functional block>	Coordination and Transfer (PJ.10-93)
<ALLOCATED_TO>	<System>	ADSP ATC (PJ.10-93)
<ALLOCATED_TO>	<FunctionView>	[NSV-4) Arch U - D5-Enter Operational Mode of Receiving ATSU

[REQ]

Identifier	REQ-10-W2.93-TS-DDA.0018
Title	Third Parties Involvement
Requirement	The system(s) of the ATSU(s) adjacent to the modified AoR shall also be reconfigured for determining correct transferring/receiving ATSU of the flights by using the proper LoA.
Status	<validated>
Rationale	If a sector is moved from one ATSU to another one, the other potential neighbouring ATSU(s) of this sector have to adapt their configuration(s) accordingly.
Category	<Functional>

[REQ Trace]

Relationship	Linked Element Type	Identifier
<ALLOCATED_TO>	<SESAR Solution>	PJ.10-W2-93C PJ.10-W2-93A
<SATISFIES>	< ATMS Requirement>	REQ-PJ.10-W2.93-SPRINTEROP-0026
<SATISFIES>	< ATMS Requirement>	REQ-PJ.10-W2.93-SPRINTEROP-0027
<ALLOCATED_TO>	<Enabler>	ER APP ATC 209_Management in the ADSP of Delegation of ATS provision between ATUs with Dynamic AoRs in a Y-Architecture ER APP ATC 197_Management in the ADSP of Delegation of ATS provision between ATSU with Dynamic AoRs for U-Architecture

<ALLOCATED_TO>	<Functional block>	Coordination and Transfer (PJ.10-93) Operational Supervision Data Management ER/APP ATC (PJ.10-93)
<ALLOCATED_TO>	<System>	ADSP ATC (PJ.10-93)

[REQ]

Identifier	REQ-10-W2.93-TS-DDA.0019
Title	New OLDI Channels in a U architecture
Requirement	The system(s) of the ATSU(s) adjacent to the modified AoR shall have OLDI channels ready be used as required for a specific delegation.
Status	<in progress>
Rationale	If a sector is moved from one ATSU to another one, the other potential neighbouring ATSU(s) may become direct neighbouring of a new ATSU.
Category	<Functional>

[REQ Trace]

Relationship	Linked Element Type	Identifier
<ALLOCATED_TO>	<SESAR Solution>	PJ.10-W2-93C
<SATISFIES>	<ATMS Requirement>	REQ-PJ.10-W2.93-SPRINTEROP-0026
<ALLOCATED_TO>	<Enabler>	ER APP ATC 196_Management in the VC ATSU of Delegation of ATS provision between ATSU's with Dynamic AoRs for U-Architecture ER APP ATC 197_Management in the ADSP of Delegation of ATS provision between ATSU's with Dynamic AoRs for U-Architecture
<ALLOCATED_TO>	<Functional block>	Legacy G/G Datalink Communications Support Functions HMI ER/APP (PJ.10-93) Support Functions Data Management ER/APP (PJ.10-93)
<ALLOCATED_TO>	<System>	VC ATSU ATC (PJ.10-93) ADSP ATC (PJ.10-93)

[REQ]

Identifier	REQ-10-W2.93-TS-DDA.0020
------------	--------------------------

Title	Datalink in a U architecture
Requirement	For Delegation with Dynamic AoRs in a U architecture, and when the ADSP is transferring a sector to another ADSP, the system shall trigger the datalink transfer of the flights under its responsibility.
Status	<in progress>
Rationale	Datalink has to be included in the delegation processing. The impact on Datalink services will need to be assessed further.
Category	<Functional>

[REQ Trace]

Relationship	Linked Element Type	Identifier
<ALLOCATED_TO>	<SESAR Solution>	PJ.10-W2-93C
<SATISFIES>	< ATMS Requirement>	REQ-PJ.10-W2.93-SPRINTEROP-0027
<ALLOCATED_TO>	<Enabler>	ER APP ATC 197_Management in the ADSP of Delegation of ATS provision between ATSU with Dynamic AoRs for U-Architecture
<ALLOCATED_TO>	<Functional block>	A/G Datalink Services Operational Supervision Data Management ER/APP ATC (PJ.10-93)
<ALLOCATED_TO>	<System>	ADSP ATC (PJ.10-93)

[REQ]

Identifier	REQ-10-W2.93-TS-DDA.0021
Title	Airspace Definition in a U architecture
Requirement	For Delegation with Dynamic AoRs in a U architecture, all ATSU possibly involved in an ATS delegation shall share an accurate view of the volumetric airspace subject to delegation in advance.
Status	<in progress>
Rationale	There can be no ambiguity about the exact volume of a pre-defined airspace subject to delegation, as this definition directly affects the safety, regulatory (licensing of ATCOs) and technical (system design and adaptation) aspects of the delegation.
Category	<Functional>

[REQ Trace]

Relationship	Linked Element Type	Identifier

<ALLOCATED_TO>	<SESAR Solution>	PJ.10-W2-93C
<SATISFIES>	< ATMS Requirement>	REQ-PJ.10-W2.93-SPRINTEROP-0004
<SATISFIES>	< ATMS Requirement>	REQ-PJ.10-W2.93-SPRINTEROP-0005
<ALLOCATED_TO>	<Enabler>	ER APP ATC 197_Management in the ADSP of Delegation of ATS provision between ATSUs with Dynamic AoRs for U-Architecture
<ALLOCATED_TO>	<Functional block>	Support Functions Data Management ER/APP (PJ.10-93)
<ALLOCATED_TO>	<System>	ADSP ATC (PJ.10-93)

[REQ]

Identifier	REQ-10-W2.93-TS-DDA.0022
Title	Shared Airspace in a U architecture
Requirement	For Delegation with Dynamic AoRs in a U architecture, all ATSUs possibly involved in an ATS delegation shall implement the shared volumetric airspace subject to delegation.
Status	<in progress>
Rationale	There cannot be any ambiguity about the exact volume of a pre-defined airspace subject to delegation.
Category	<Functional>

[REQ Trace]

Relationship	Linked Element Type	Identifier
<ALLOCATED_TO>	<SESAR Solution>	PJ.10-W2-93C
<SATISFIES>	< ATMS Requirement>	REQ-PJ.10-W2.93-SPRINTEROP-0004
<SATISFIES>	< ATMS Requirement>	REQ-PJ.10-W2.93-SPRINTEROP-0005
<ALLOCATED_TO>	<Enabler>	ER APP ATC 197_Management in the ADSP of Delegation of ATS provision between ATSUs with Dynamic AoRs for U-Architecture
<ALLOCATED_TO>	<Functional block>	Support Functions Data Management ER/APP (PJ.10-93)
<ALLOCATED_TO>	<System>	ADSP ATC (PJ.10-93)

4.2.1.1.5 Delegation with Static/Dynamic AoRs (Architectures "Y", "D", "U")

[REQ]

Identifier	REQ-10-W2.93-TS-DSD.0001
Title	Sector Consolidation
Requirement	When processing a delegation with dynamic AoRs, or with static AoRs within a common ADSP, the system shall allow a receiving position to take the control of a delegated sector in consolidation of a sector already under control on this position prior to the delegation.
Status	<validated>
Rationale	<p>If the target of a delegation is to consolidate the delegated sector with another sector in the receiving ATSU, the delegation process should not oblige first the delegation on a dedicated position with a dedicated team, and then in a second step to operate the consolidation in the receiving ATSU. This should be done in a single step during the initialisation of the delegation.</p> <p>However it must be kept in mind that consolidation with static AoRs and 2 ADSPs is not possible.</p>
Category	<Functional>

[REQ Trace]

Relationship	Linked Element Type	Identifier
<ALLOCATED_TO>	<SESAR Solution>	PJ.10-W2-93A PJ.10-W2-93C
<SATISFIES>	< ATMS Requirement>	REQ-PJ.10-W2.93-SPRINTEROP-0009
<ALLOCATED_TO>	<Enabler>	<p>ER APP ATC 196_Management in the VC ATSU of Delegation of ATS provision between ATSU with Dynamic AoRs for U-Architecture</p> <p>ER APP ATC 197_Management in the ADSP of Delegation of ATS provision between ATSU with Dynamic AoRs for U-Architecture</p> <p>ER APP ATC 209_Management in the ADSP of Delegation of ATS provision between ATU with Dynamic AoRs in a Y-Architecture</p> <p>ER APP ATC 218_Management in the VC ATU of Delegation of ATS provision between ATU with Dynamic AoRs in a Y-Architecture</p>
<ALLOCATED_TO>	<Functional block>	<p>Operational Supervision HMI ER/APP ATC (PJ.10-93)</p> <p>Operational Supervision Data Management ER/APP ATC (PJ.10-93)</p> <p>Controller Human Machine Interaction Management ER/APP (PJ.10-93)</p>

<ALLOCATED_TO>	<System>	ADSP ATC (PJ.10-93) VC ATSU ATC (PJ.10-93)
----------------	----------	---

[REQ]

Identifier	REQ-10-W2.93-TS-DSD.0002
Title	Delegating/Receiving Communication
Requirement	For a specific sector, the system shall allow the receiving ATCO team and the delegating ATCO team to communicate together by voice.
Status	<validated>
Rationale	The receiving team should handle transparently the delegated sector communication channels, but by default both receiving and delegating ATCO VCSs might not have a configuration allowing a contact between themselves.
Category	<Functional>

[REQ Trace]

Relationship	Linked Element Type	Identifier
<ALLOCATED_TO>	<SESAR Solution>	PJ.10-W2-93A PJ.10-W2-93B PJ.10-W2-93C
<SATISFIES>	< ATMS Requirement>	REQ-PJ.10-W2.93-SPRINTEROP-0022
<SATISFIES>	< ATMS Requirement>	REQ-PJ.10-W2.93-SPRINTEROP-0011
<SATISFIES>	< ATMS Requirement>	REQ-PJ.10-W2.93-SPRINTEROP-0034
<ALLOCATED_TO>	<Enabler>	ER APP ATC 197_Management in the ADSP of Delegation of ATS provision between ATSU with Dynamic AoRs for U-Architecture ER APP ATC 209_Management in the ADSP of Delegation of ATS provision between ATU with Dynamic AoRs in a Y-Architecture ER APP ATC 217_Management in the ADSP of Delegation of ATS provision between ATU with Static AoRs in a D-Architecture
<ALLOCATED_TO>	<Functional block>	G/G Voice Communication (PJ.10-93)
<ALLOCATED_TO>	<System>	ADSP Voice (PJ.10-93)

[REQ]

Identifier	REQ-10-W2.93-TS-DSD.0003
Title	System Support for Delegated Sector
Requirement	For managing a delegated sector, the system shall provide the ATCO with the same system functions as the ones provided in the receiving ATSU.
Status	<validated>
Rationale	The receiving ATCO should control a sector safely with known functions, and consistently with grouped sectors from different ATSUs.
Category	<Functional>

[REQ Trace]

Relationship	Linked Element Type	Identifier
<ALLOCATED_TO>	<SESAR Solution>	PJ.10-W2-93A
		PJ.10-W2-93B
		PJ.10-W2-93C
<SATISFIES>	< ATMS Requirement>	REQ-PJ.10-W2.93-SPRINTEROP-SYS.0006
<ALLOCATED_TO>	<Enabler>	ER APP ATC 215_Management in the VC ATSU of Delegation of ATS Provision between ATUs with Static AoRs in a D-Architecture ER APP ATC 195_Management in the VC ATSU of Delegation of ATS Provision between ATSUs with Static AoRs for Y-Architecture ER APP ATC 196_Management in the VC ATSU of Delegation of ATS provision between ATSUs with Dynamic AoRs for U-Architecture ER APP ATC 218_Management in the VC ATSU of Delegation of ATS provision between ATUs with Dynamic AoRs in a Y-Architecture
<ALLOCATED_TO>	<System>	VC ATSU ATC (PJ.10-93)

4.2.1.1.6 Preview Mode (Architectures "Y", "D", "U")

[REQ]

Identifier	REQ-10-W2.93-TS-DPM.0001
Title	Preview Mode Setting
Requirement	The system shall support the preview mode selection for the sectors being delegated.
Status	<validated>

Rationale	Before endorsing a sector responsibility, an ATCO team must have access to the situation without being yet in charge of the sector. Short after the endorsement, the delegating team may still keep an eye on the situation in order to provide some support if required.
Category	<Functional>

[REQ Trace]

Relationship	Linked Element Type	Identifier
<ALLOCATED_TO>	<SESAR Solution>	PJ.10-W2-93A PJ.10-W2-93B PJ.10-W2-93C
<SATISFIES>	< ATMS Requirement>	REQ-PJ.10-W2.93-SPRINTEROP-0023
<SATISFIES>	< ATMS Requirement>	REQ-PJ.10-W2.93-SPRINTEROP-0055
<ALLOCATED_TO>	<Enabler>	ER APP ATC 193_Management in the VC ATSU of a CWP preview mode during delegation of ATS Provision between ATUs ER APP ATC 194_Management in the ADSP of a CWP preview mode during delegation of ATS Provision between ATSUs
<ALLOCATED_TO>	<Functional block>	Operational Supervision HMI ER/APP ATC (PJ.10-93) Operational Supervision Data Management ER/APP ATC (PJ.10-93) Controller Human Machine Interaction Management ER/APP (PJ.10-93)
<ALLOCATED_TO>	<System>	VC ATSU ATC (PJ.10-93) ADSP ATC (PJ.10-93)
<ALLOCATED_TO>	<FunctionView>	[NSV-4) Arch D - D2-Enter Preview Mode [NSV-4) Arch U - D2-Enter Preview Mode [NSV-4) Arch Y - D0-Delegation Process Overview

[REQ]

Identifier	REQ-10-W2.93-TS-DPM.0006
Title	Operational to Preview Mode

Requirement	The system shall allow the deallocated sector(s) of the delegating ATSU to remain temporarily in preview mode after the delegated sector has been transferred to the receiving ATSU.
Status	<validated>
Rationale	It is expected, mostly for safety reasons, that a delegating ATCO team retains the visualization of the sector a certain time after the delegated sector has been transferred to the receiving ATSU.
Category	<Safety> , <Functional>

[REQ Trace]

Relationship	Linked Element Type	Identifier
<ALLOCATED_TO>	<SESAR Solution>	PJ.10-W2-93A PJ.10-W2-93B PJ.10-W2-93C
<SATISFIES>	< ATMS Requirement>	REQ-PJ.10-W2.93-SPRINTEROP-0027
<ALLOCATED_TO>	<Enabler>	ER APP ATC 193_Management in the VC ATSU of a CWP preview mode during delegation of ATS Provision between ATUs ER APP ATC 194_Management in the ADSP of a CWP preview mode during delegation of ATS Provision between ATSU
<ALLOCATED_TO>	<Functional block>	Operational Supervision HMI ER/APP ATC (PJ.10-93) Operational Supervision Data Management ER/APP ATC (PJ.10-93)
<ALLOCATED_TO>	<System>	ADSP ATC (PJ.10-93) VC ATSU ATC (PJ.10-93)
<ALLOCATED_TO>	<FunctionView>	[NSV-4] Arch U - D5-Enter Operational Mode of Receiving ATSU [NSV-4] Arch Y - D0-Delegation Process Overview

[REQ]

Identifier	REQ-10-W2.93-TS-DPM.0002
Title	Preview Expectation
Requirement	The system shall provide the working position in preview mode with all necessary flight and environment information relative to one or several sectors, in order to be in a position to endorse shortly the authority on the sector(s).

Status	<validated>
Rationale	All traffic and up-to-date related information must be displayed previously to taking a delegation.
Category	<Functional>

[REQ Trace]

Relationship	Linked Element Type	Identifier
<ALLOCATED_TO>	<SESAR Solution>	PJ.10-W2-93A PJ.10-W2-93B PJ.10-W2-93C
<SATISFIES>	< ATMS Requirement>	REQ-PJ.10-W2.93-SPRINTEROP-0014
<SATISFIES>	< ATMS Requirement>	REQ-PJ.10-W2.93-SPRINTEROP-SYS.0001
<SATISFIES>	< ATMS Requirement>	REQ-PJ.10-W2.93-SPRINTEROP-SYS.0005
<SATISFIES>	< ATMS Requirement>	REQ-PJ.10-W2.93-SPRINTEROP-0067
<SATISFIES>	< ATMS Requirement>	REQ-PJ.10-W2.93-SPRINTEROP-0112
<ALLOCATED_TO>	<Enabler>	ER APP ATC 194_Management in the ADSP of a CWP preview mode during delegation of ATS Provision between ATSUs
<ALLOCATED_TO>	<Functional block>	Flight Planning - Lifecycle Management - Data Distribution (PJ.10-93) Support Functions Data Management ER/APP (PJ.10-93) Surveillance
<ALLOCATED_TO>	<System>	ADSP ATC (PJ.10-93)
<ALLOCATED_TO>	<FunctionView>	[NSV-4) Arch U - D5-Enter Operational Mode of Receiving ATSU [NSV-4) Arch U - D2-Enter Preview Mode [NSV-4) Arch Y - D0-Delegation Process Overview

[REQ]

Identifier	REQ-10-W2.93-TS-DPM.0003
Title	Preview Information

Requirement	<p>The system shall at least provide the working position in preview mode with:</p> <ul style="list-style-type: none"> • the tracks, the FP information and their correlation • the sector status of the flights • the weather information • airspace reservations and CDRs status
Status	<validated>
Rationale	All the data handled by a CWP might not necessarily be provided to a CWP handling remotely a sector. However, a minimum set is expected as being compulsory for safely executing the control of a sector.
Category	<Functional>

[REQ Trace]

Relationship	Linked Element Type	Identifier
<ALLOCATED_TO>	<SESAR Solution>	PJ.10-W2-93A PJ.10-W2-93B PJ.10-W2-93C
<SATISFIES>	< ATMS Requirement>	REQ-PJ.10-W2.93-SPRINTEROP-0014
<SATISFIES>	< ATMS Requirement>	REQ-PJ.10-W2.93-SPRINTEROP-SYS.0002
<SATISFIES>	< ATMS Requirement>	REQ-PJ.10-W2.93-SPRINTEROP-0067
<ALLOCATED_TO>	<Enabler>	ER APP ATC 194_Management in the ADSP of a CWP preview mode during delegation of ATS Provision between ATSUs
<ALLOCATED_TO>	<Functional block>	Surveillance Support Functions Data Management ER/APP (PJ.10-93) Flight Planning - Lifecycle Management - Data Distribution (PJ.10-93)
<ALLOCATED_TO>	<System>	ADSP ATC (PJ.10-93)

[REQ]

Identifier	REQ-10-W2.93-TS-DPM.0004
Title	Preview Mode - System Managed
Requirement	The system shall reject/inhibit flight inputs for the working positions being in preview mode.

Status	<validated>
Rationale	<p>Two different ATCO teams having access to a common sector simultaneously, the exclusive control from only one team is primarily insured by procedures, but reinforced as well by system controls when the preview mode is system managed. When the preview mode is not system-managed (i.e. Preview Mode - Procedures Managed), it relies entirely on procedures, which are expected to prevent to be inconsistently operated.</p> <p>The rejection/inhibition of instruction requests in preview mode system-managed can be achieved either by the ATSU system (CWP) or by the ADSP system.</p>
Category	<Functional>

[REQ Trace]

Relationship	Linked Element Type	Identifier
<ALLOCATED_TO>	<SESAR Solution>	PJ.10-W2-93A PJ.10-W2-93B PJ.10-W2-93C
<SATISFIES>	<ATMS Requirement>	REQ-PJ.10-W2.93-SPRINTEROP-0015
<ALLOCATED_TO>	<Enabler>	ER APP ATC 193_Management in the VC ATSU of a CWP preview mode during delegation of ATS Provision between ATUs ER APP ATC 194_Management in the ADSP of a CWP preview mode during delegation of ATS Provision between ATSUs
<ALLOCATED_TO>	<Functional block>	Controller Human Machine Interaction Management ER/APP (PJ.10-93) Trajectory Prediction and Management (PJ.10-93)
<ALLOCATED_TO>	<System>	VC ATSU ATC (PJ.10-93) ADSP ATC (PJ.10-93)
<ALLOCATED_TO>	<FunctionView>	[NSV-4) Arch Y - D0-Delegation Process Overview

[REQ]

Identifier	REQ-10-W2.93-TS-DPM.0005
Title	Operational and Preview Modes Consolidation

Requirement	A receiving CWP shall display and support the expected behaviour of a delegated sector in preview mode without interfering with the sectors that were already under its operational control before initiating the delegation.
Status	<validated>
Rationale	The preview mode of a sector should not impact the calculated coordinations, nor restrict the clearance inputs of the sectors in operational mode on the same CWP
Category	<Functional>

[REQ Trace]

Relationship	Linked Element Type	Identifier
<ALLOCATED_TO>	<SESAR Solution>	PJ.10-W2-93A PJ.10-W2-93B PJ.10-W2-93C
<SATISFIES>	<ATMS Requirement>	REQ-PJ.10-W2-93-SPRINTEROP-0014
<ALLOCATED_TO>	<Enabler>	ER APP ATC 193_Management in the VC ATSU of a CWP preview mode during delegation of ATS Provision between ATUs ER APP ATC 194_Management in the ADSP of a CWP preview mode during delegation of ATS Provision between ATUSUs
<ALLOCATED_TO>	<Functional block>	Trajectory Prediction and Management (PJ.10-93) Controller Human Machine Interaction Management ER/APP (PJ.10-93)
<ALLOCATED_TO>	<System>	VC ATSU ATC (PJ.10-93) ADSP ATC (PJ.10-93)
<ALLOCATED_TO>	<FunctionView>	[NSV-4] Arch Y - D0-Delegation Process Overview

[REQ]

Identifier	REQ-10-W2.93-TS-DPM.0007
Title	Flights to be Handed Over
Requirement	The system shall provide a means for an ATCO during preview mode to identify the flights to be handed over for the delegation.
Status	<validated>
Rationale	System assistance for safe hand over.

Category	<Functional>
----------	--------------

[REQ Trace]

Relationship	Linked Element Type	Identifier
<ALLOCATED_TO>	<SESAR Solution>	PJ.10-W2-93A PJ.10-W2-93B PJ.10-W2-93C
<SATISFIES>	< ATMS Requirement>	REQ-PJ.10-W2.93-SPRINTEROP-0093
<SATISFIES>	< ATMS Requirement>	REQ-PJ.10-W2.93-SPRINTEROP-0112
<ALLOCATED_TO>	<Enabler>	ER APP ATC 193_Management in the VC ATSU of a CWP preview mode during delegation of ATS Provision between ATSUs ER APP ATC 194_Management in the ADSP of a CWP preview mode during delegation of ATS Provision between ATSUs
<ALLOCATED_TO>	<Functional block>	Controller Human Machine Interaction Management ER/APP (PJ.10-93) Coordination and Transfer (PJ.10-93) Flight Planning - Lifecycle Management - Data Distribution (PJ.10-93)
<ALLOCATED_TO>	<System>	VC ATSU ATC (PJ.10-93) ADSP ATC (PJ.10-93)

[REQ]

Identifier	REQ-10-W2.93-TS-DPM.0008
Title	Flight Point Out
Requirement	The system shall provide a flight point-out function to the delegating ATCO.
Status	<validated>
Rationale	The system should provide the pointout to avoid misunderstandings between the delegating and the receiving ATCO team
Category	<Functional>

[REQ Trace]

Relationship	Linked Element Type	Identifier
--------------	---------------------	------------

<ALLOCATED_TO>	<SESAR Solution>	PJ.10-W2-93A PJ.10-W2-93B PJ.10-W2-93C
<SATISFIES>	< ATMS Requirement>	REQ-PJ.10-W2.93-SPRINTEROP-0094
<ALLOCATED_TO>	<Enabler>	SVC-010_Provision and Consumption of CoordinationAndTransferManagement Service in the context of Virtual Centres SVC-008_Provision and Consumption of FlightDataDistribution Service in the context of Virtual Centres.
<ALLOCATED_TO>	<Functional block>	Coordination and Transfer (PJ.10-93) Controller Human Machine Interaction Management ER/APP (PJ.10-93) Legacy G/G Datalink Communications (PJ.10-93)
<ALLOCATED_TO>	<System>	VC ATSU ATC (PJ.10-93) ADSP ATC (PJ.10-93)

[REQ]

Identifier	REQ-10-W2.93-TS-DPM.0009
Title	Mode Identification
Requirement	The system shall allow the ATCOs of the receiving ATSU to distinguish the sectors displayed for operational mode from those displayed for preview mode - system managed.
Status	<validated>
Rationale	Good understanding of which mode is applied to which sector is required for safety.
Category	<Functional>

[REQ Trace]

Relationship	Linked Element Type	Identifier
<ALLOCATED_TO>	<SESAR Solution>	PJ.10-W2-93B PJ.10-W2-93A PJ.10-W2-93C
<SATISFIES>	< ATMS Requirement>	REQ-PJ.10-W2.93-SPRINTEROP-0097

<ALLOCATED_TO>	<Enabler>	ER APP ATC 193_Management in the VC ATSU of a CWP preview mode during delegation of ATS Provision between ATSUs
<ALLOCATED_TO>	<Functional block>	Controller Human Machine Interaction Management ER/APP (PJ.10-93)
<ALLOCATED_TO>	<System>	VC ATSU ATC (PJ.10-93)

[REQ]

Identifier	REQ-10-W2.93-TS-DPM.0010
Title	Termination Identification
Requirement	When the positions of the receiving ATSUs have switched to the operational mode - system managed, the system shall provide a means for identifying the end of the preview mode on the positions of the delegating ATSU.
Status	<validated>
Rationale	It is relevant for the receiving ATCOs to know that the delegating ATCOs still have a view of the sector. This is not assigned to U architecture since the information is not straight available.
Category	<Functional>

[REQ Trace]

Relationship	Linked Element Type	Identifier
<ALLOCATED_TO>	<SESAR Solution>	PJ.10-W2-93B PJ.10-W2-93A
<SATISFIES>	< ATMS Requirement>	REQ-PJ.10-W2.93-SPRINTEROP-0110
<ALLOCATED_TO>	<Enabler>	ER APP ATC 193_Management in the VC ATSU of a CWP preview mode during delegation of ATS Provision between ATSUs
<ALLOCATED_TO>	<Functional block>	Controller Human Machine Interaction Management ER/APP (PJ.10-93)
<ALLOCATED_TO>	<System>	VC ATSU ATC (PJ.10-93)

4.2.1.1.7 Switch Preview/Operational Mode (Architectures "Y", "D", "U")

[REQ]

Identifier	REQ-10-W2.93-TS-DSM.0014
Title	Initiate Request

Requirement	The system shall allow a sector to be launched in preview mode.
Status	<validated>
Rationale	Starting a delegation in the receiving ATSU requires to launch a new sector in preview mode; i.e. this is not a mode switch from a running sector.
Category	<Functional>

[REQ Trace]

Relationship	Linked Element Type	Identifier
<ALLOCATED_TO>	<SESAR Solution>	PJ.10-W2-93C PJ.10-W2-93B PJ.10-W2-93A
<SATISFIES>	<ATMS Requirement>	REQ-PJ.10-W2.93-SPRINTEROP-0088
<ALLOCATED_TO>	<Enabler>	ER APP ATC 193_Management in the VC ATSU of a CWP preview mode during delegation of ATS Provision between ATSUs ER APP ATC 194_Management in the ADSP of a CWP preview mode during delegation of ATS Provision between ATSUs
<ALLOCATED_TO>	<Functional block>	Operational Supervision Data Management ER/APP ATC (PJ.10-93) Operational Supervision HMI ER/APP ATC (PJ.10-93)
<ALLOCATED_TO>	<System>	VC ATSU ATC (PJ.10-93) ADSP ATC (PJ.10-93)

[REQ]

Identifier	REQ-10-W2.93-TS-DSM.0001
Title	Switch Request
Requirement	The system shall allow the sector(s) to be switched from preview mode to operational mode.
Status	<validated>
Rationale	Switch is required on demand.
Category	<Functional>

[REQ Trace]

Relationship	Linked Element Type	Identifier
<ALLOCATED_TO>	<SESAR Solution>	PJ.10-W2-93A PJ.10-W2-93B PJ.10-W2-93C
<SATISFIES>	< ATMS Requirement>	REQ-PJ.10-W2.93-SPRINTEROP-0025
<SATISFIES>	< ATMS Requirement>	REQ-PJ.10-W2.93-SPRINTEROP-0026
<SATISFIES>	< ATMS Requirement>	REQ-PJ.10-W2.93-SPRINTEROP-0058
<ALLOCATED_TO>	<Enabler>	ER APP ATC 193_Management in the VC ATSU of a CWP preview mode during delegation of ATS Provision between ATUs ER APP ATC 194_Management in the ADSP of a CWP preview mode during delegation of ATS Provision between ATUs
<ALLOCATED_TO>	<Functional block>	Operational Supervision HMI ER/APP ATC (PJ.10-93) Operational Supervision Data Management ER/APP ATC (PJ.10-93)
<ALLOCATED_TO>	<System>	VC ATSU ATC (PJ.10-93) ADSP ATC (PJ.10-93)
<ALLOCATED_TO>	<FunctionView>	[NSV-4) Arch Y - D0-Delegation Process Overview [NSV-4) Arch U - D5-Enter Operational Mode of Receiving ATSU

[REQ]

Identifier	REQ-10-W2.93-TS-DSM.0002
Title	Instructions Enabling
Requirement	When switching to operational mode, the system shall allow the input of instruction requests on the given working positions of the switched sector(s)
Status	<validated>
Rationale	Explicit Preview mode is required for inhibiting Input commands from ATCO who are not yet in charge of the sector.
Category	<Functional>

[REQ Trace]

Relationship	Linked Element Type	Identifier

<ALLOCATED_TO>	<SESAR Solution>	PJ.10-W2-93A PJ.10-W2-93B PJ.10-W2-93C
<SATISFIES>	< ATMS Requirement>	REQ-PJ.10-W2.93-SPRINTEROP-0015
<ALLOCATED_TO>	<Enabler>	ER APP ATC 193_Management in the VC ATSU of a CWP preview mode during delegation of ATS Provision between ATUs ER APP ATC 194_Management in the ADSP of a CWP preview mode during delegation of ATS Provision between ATUs
<ALLOCATED_TO>	<Functional block>	Trajectory Prediction and Management (PJ.10-93) Controller Human Machine Interaction Management ER/APP (PJ.10-93)
<ALLOCATED_TO>	<System>	VC ATSU ATC (PJ.10-93) ADSP ATC (PJ.10-93)
<ALLOCATED_TO>	<FunctionView>	[NSV-4] Arch Y - D0-Delegation Process Overview [NSV-4] Arch U - D5-Enter Operational Mode of Receiving ATSU

[REQ]

Identifier	REQ-10-W2.93-TS-DSM.0003
Title	Switch to Preview Mode
Requirement	The system shall allow the sector(s) to be switched from operational mode to preview mode.
Status	<validated>
Rationale	Transition through preview mode for a position that has delegated a sector is not mandatory.
Category	<Functional>

[REQ Trace]

Relationship	Linked Element Type	Identifier
<ALLOCATED_TO>	<SESAR Solution>	PJ.10-W2-93A PJ.10-W2-93B PJ.10-W2-93C
<SATISFIES>	< ATMS Requirement>	REQ-PJ.10-W2.93-SPRINTEROP-0027

<ALLOCATED_TO>	<Enabler>	ER APP ATC 193_Management in the VC ATSU of a CWP preview mode during delegation of ATS Provision between ATUs ER APP ATC 194_Management in the ADSP of a CWP preview mode during delegation of ATS Provision between ATSU
<ALLOCATED_TO>	<Functional block>	Operational Supervision HMI ER/APP ATC (PJ.10-93) Operational Supervision Data Management ER/APP ATC (PJ.10-93)
<ALLOCATED_TO>	<System>	VC ATSU ATC (PJ.10-93) ADSP ATC (PJ.10-93)
<ALLOCATED_TO>	<FunctionView>	[NSV-4) Arch U - D5-Enter Operational Mode of Receiving ATSU [NSV-4) Arch Y - D0-Delegation Process Overview

[REQ]

Identifier	REQ-10-W2.93-TS-DSM.0004
Title	Preview Mode Cancellation
Requirement	The system shall allow the preview mode to be cancelled.
Status	<validated>
Rationale	The delegation abortion may require the cancellation of the preview mode on the receiving positions when the preview is active. The cancellation is required as well when the delegation is in operation and the delegating positions can safely exit the preview mode.
Category	<Functional>

[REQ Trace]

Relationship	Linked Element Type	Identifier
<ALLOCATED_TO>	<SESAR Solution>	PJ.10-W2-93A PJ.10-W2-93B PJ.10-W2-93C
<SATISFIES>	< ATMS Requirement>	REQ-PJ.10-W2.93-SPRINTEROP-0019
<SATISFIES>	< ATMS Requirement>	REQ-PJ.10-W2.93-SPRINTEROP-0020

<SATISFIES>	< ATMS Requirement>	REQ-PJ.10-W2.93-SPRINTEROP-0056
<ALLOCATED_TO>	<Enabler>	ER APP ATC 194_Management in the ADSP of a CWP preview mode during delegation of ATS Provision between ATSU's ER APP ATC 193_Management in the VC ATSU of a CWP preview mode during delegation of ATS Provision between ATSU's
<ALLOCATED_TO>	<Functional block>	Operational Supervision HMI ER/APP ATC (PJ.10-93) Operational Supervision Data Management ER/APP ATC (PJ.10-93)
<ALLOCATED_TO>	<System>	VC ATSU ATC (PJ.10-93) ADSP ATC (PJ.10-93)
<ALLOCATED_TO>	<FunctionView>	[NSV-4) Arch Y - D4b-Abort Delegation

[REQ]

Identifier	REQ-10-W2.93-TS-DSM.0005
Title	Abort Command
Requirement	Until the receiving CWPs handling the delegated sector(s) are switched to operational mode, the system shall allow the delegation to be aborted.
Status	<validated>
Rationale	The delegation may be aborted until the very end of the preview phase of the receiving positions. Once the receiving positions are in operational mode, an abortion has to be executed only through a new delegation of the sector(s).
Category	<Functional> , <HMI>

[REQ Trace]

Relationship	Linked Element Type	Identifier
<ALLOCATED_TO>	<SESAR Solution>	PJ.10-W2-93A PJ.10-W2-93B PJ.10-W2-93C
<SATISFIES>	< ATMS Requirement>	REQ-PJ.10-W2.93-SPRINTEROP-0057
<SATISFIES>	< ATMS Requirement>	REQ-PJ.10-W2.93-SPRINTEROP-0056
<ALLOCATED_TO>	<Enabler>	ER APP ATC 193_Management in the VC ATSU of a CWP preview mode during delegation of ATS Provision between ATU's

		ER APP ATC 194_Management in the ADSP of a CWP preview mode during delegation of ATS Provision between ATSUs
<ALLOCATED_TO>	<Functional block>	Operational Supervision HMI ER/APP ATC (PJ.10-93) Operational Supervision Data Management ER/APP ATC (PJ.10-93)
<ALLOCATED_TO>	<System>	VC ATSU ATC (PJ.10-93) ADSP ATC (PJ.10-93)
<ALLOCATED_TO>	<FunctionView>	[NSV-4) Arch Y - D0-Delegation Process Overview

[REQ]

Identifier	REQ-10-W2.93-TS-DSM.0006
Title	Preview Mode Operations Synchronization
Requirement	The various preview mode operations (Switches and Cancellation) applied on a sector shall be applied simultaneously to all the working positions handling that sector.
Status	<validated>
Rationale	The preview mode has to be applied to the whole set of CWPs handling a common sector (the ATCO team).
Category	<Functional>

[REQ Trace]

Relationship	Linked Element Type	Identifier
<ALLOCATED_TO>	<SESAR Solution>	PJ.10-W2-93A PJ.10-W2-93B PJ.10-W2-93C
<SATISFIES>	< ATMS Requirement>	REQ-PJ.10-W2.93-SPRINTEROP-0020
<ALLOCATED_TO>	<Enabler>	ER APP ATC 194_Management in the ADSP of a CWP preview mode during delegation of ATS Provision between ATSUs
<ALLOCATED_TO>	<Functional block>	Operational Supervision Data Management ER/APP ATC (PJ.10-93)
<ALLOCATED_TO>	<System>	ADSP ATC (PJ.10-93)
<ALLOCATED_TO>	<FunctionView>	[NSV-4) Arch Y - D0-Delegation Process Overview

		[NSV-4] Arch Y - D4b-Abort Delegation
		[NSV-4] Arch U - D5-Enter Operational Mode of Receiving ATSU

[REQ]

Identifier	REQ-10-W2.93-TS-DSM.0007
Title	Rollback
Requirement	Following a preview mode cancellation, the system shall reset the working position to the sector configuration that was effective previously to the delegation.
Status	<validated>
Rationale	The preview mode cancellation only applies onto a given sector and does not concern the other sector(s) that might be collocated on the same working position.
Category	<Functional>

[REQ Trace]

Relationship	Linked Element Type	Identifier
<ALLOCATED_TO>	<SESAR Solution>	PJ.10-W2-93A PJ.10-W2-93B PJ.10-W2-93C
<SATISFIES>	< ATMS Requirement>	REQ-PJ.10-W2.93-SPRINTEROP-0021
<ALLOCATED_TO>	<Enabler>	ER APP ATC 194_Management in the ADSP of a CWP preview mode during delegation of ATS Provision between ATSUs
<ALLOCATED_TO>	<Functional block>	Operational Supervision Data Management ER/APP ATC (PJ.10-93)
<ALLOCATED_TO>	<System>	ADSP ATC (PJ.10-93)
<ALLOCATED_TO>	<FunctionView>	[NSV-4] Arch Y - D4b-Abort Delegation

[REQ]

Identifier	REQ-10-W2.93-TS-DSM.0011
Title	RX Automatic Activation for Receiving ATSU
Requirement	When activating the preview mode in a delegated sector in a receiving position, the system should activate in Rx the delegated frequency in the corresponding Executive CWP.

Status	<in progress>
Rationale	This should decrease the number of actions expected from the controller and avoid the risk of not enabling the communication channel.
Category	<Functional>

[REQ Trace]

Relationship	Linked Element Type	Identifier
<ALLOCATED_TO>	<SESAR Solution>	PJ.10-W2-93A
		PJ.10-W2-93B
		PJ.10-W2-93C
<SATISFIES>	< ATMS Requirement>	REQ-PJ.10-W2-93-SPRINTEROP-0089
<ALLOCATED_TO>	<Enabler>	ER APP ATC 194_Management in the ADSP of a CWP preview mode during delegation of ATS Provision between ATSUs
<ALLOCATED_TO>	<Functional block>	A/G Voice Communication (PJ.10-93)
<ALLOCATED_TO>	<System>	ADSP Voice (PJ.10-93)

[REQ]

Identifier	REQ-10-W2.93-TS-DSM.0012
Title	RX Automatic Activation
Requirement	When switching from operational mode to preview mode a delegated sector in a position, the system should switch from Tx/Rx to Rx the delegated frequency in the corresponding Executive CWP.
Status	<validated>
Rationale	This should decrease the number of actions expected from the controller and avoid the risk of not disabling the Tx mode.
Category	<Functional>

[REQ Trace]

Relationship	Linked Element Type	Identifier
<ALLOCATED_TO>	<SESAR Solution>	PJ.10-W2-93A
		PJ.10-W2-93B
		PJ.10-W2-93C

<SATISFIES>	< ATMS Requirement>	REQ-PJ.10-W2.93-SPRINTEROP-0102 REQ-PJ.10-W2.93-SPRINTEROP-0103
<ALLOCATED_TO>	<Enabler>	ER APP ATC 194_Management in the ADSP of a CWP preview mode during delegation of ATS Provision between ATSUs
<ALLOCATED_TO>	<Functional block>	A/G Voice Communication (PJ.10-93)
<ALLOCATED_TO>	<System>	ADSP Voice (PJ.10-93)

[REQ]

Identifier	REQ-10-W2.93-TS-DSM.0016
Title	Automatic Frequency Closure
Requirement	The system should disable a frequency once the preview mode is terminated on a sector that has been delegated on another ATSU.
Status	<in progress>
Rationale	Frequency is not required anymore once the delegation is definitively handed over and automatic actions can decrease ATCO workload.
Category	<Functional>

[REQ Trace]

Relationship	Linked Element Type	Identifier
<ALLOCATED_TO>	<SESAR Solution>	PJ.10-W2-93A PJ.10-W2-93B PJ.10-W2-93C
<SATISFIES>	< ATMS Requirement>	REQ-PJ.10-W2.93-SPRINTEROP-0109
<ALLOCATED_TO>	<Enabler>	ER APP ATC 194_Management in the ADSP of a CWP preview mode during delegation of ATS Provision between ATSUs
<ALLOCATED_TO>	<Functional block>	A/G Voice Communication (PJ.10-93)
<ALLOCATED_TO>	<System>	ADSP Voice (PJ.10-93)

[REQ]

Identifier	REQ-10-W2.93-TS-DSM.0008
Title	Switch Trigger

Requirement	The switch of sector(s) from preview mode to operational mode (or vice versa) shall be performed either through dedicated operations, or through a global ATSU sector configuration update.
Status	<validated>
Rationale	Dedicated switch operations and change of configuration operations both end up with the same result. Switch operations are short-cuts that an ADSP may or may not offer, and when offered, that an ATSU may or may not wish to use.
Category	<Functional>

[REQ Trace]

Relationship	Linked Element Type	Identifier
<ALLOCATED_TO>	<SESAR Solution>	PJ.10-W2-93A PJ.10-W2-93B PJ.10-W2-93C
<SATISFIES>	<ATMS Requirement>	REQ-PJ.10-W2.93-SPRINTEROP-0025
<ALLOCATED_TO>	<Enabler>	ER APP ATC 193_Management in the VC ATSU of a CWP preview mode during delegation of ATS Provision between ATUs ER APP ATC 194_Management in the ADSP of a CWP preview mode during delegation of ATS Provision between ATSUs
<ALLOCATED_TO>	<Functional block>	Operational Supervision HMI ER/APP ATC (PJ.10-93) Operational Supervision Data Management ER/APP ATC (PJ.10-93)
<ALLOCATED_TO>	<System>	VC ATSU ATC (PJ.10-93) ADSP ATC (PJ.10-93)

[REQ]

Identifier	REQ-10-W2.93-TS-DSM.0009
Title	Switch Access
Requirement	Either the supervisor HMI or the ATCO HMI shall provide the way to switch between Preview and Operational Modes.
Status	<validated>
Rationale	This requirement specifies who can access to the switch provided by OPCONFM service provider.
Category	<HMI>

[REQ Trace]

Relationship	Linked Element Type	Identifier
<ALLOCATED_TO>	<SESAR Solution>	PJ.10-W2-93A PJ.10-W2-93B PJ.10-W2-93C
<SATISFIES>	< ATMS Requirement>	REQ-PJ.10-W2.93-SPRINTEROP-0025
<ALLOCATED_TO>	<Enabler>	ER APP ATC 193_Management in the VC ATSU of a CWP preview mode during delegation of ATS Provision between ATUs
<ALLOCATED_TO>	<Functional block>	Operational Supervision HMI ER/APP ATC (PJ.10-93) Controller Human Machine Interaction Management ER/APP (PJ.10-93)
<ALLOCATED_TO>	<System>	VC ATSU ATC (PJ.10-93) ADSP ATC (PJ.10-93)

4.2.1.1.8 Technical Supervision for Delegation

[REQ]

Identifier	REQ-10-W2.93-TS-TSM.0001
Title	Local Access to the Status of the Systems of the ATSU
Requirement	The ATSU system shall provide to the ATSU Supervision the status of all relevant systems running at the ATSU, including network connections to the ADSP(s).
Status	<validated>
Rationale	The ATSEP of the ATSU is in charge of monitoring all the systems of his ATSU. Such a management remains local to the ATSU (i.e. does not go through ADSP and its provided services).
Category	<Functional>

[REQ Trace]

Relationship	Linked Element Type	Identifier
<ALLOCATED_TO>	<SESAR Solution>	PJ.10-W2-93A PJ.10-W2-93B

<SATISFIES>	< ATMS Requirement>	REQ-PJ.10-W2.93-SPRINTEROP-0044
<ALLOCATED_TO>	<Enabler>	ER APP ATC 195_Management in the VC ATSU of Delegation of ATS Provision between ATSUs with Static AoRs for Y-Architecture ER APP ATC 215_Management in the VC ATSU of Delegation of ATS Provision between ATUs with Static AoRs in a D-Architecture
<ALLOCATED_TO>	<Functional block>	Technical Supervision HMI VC (PJ.10-93) Technical Supervision Voice HMI VC (PJ.10-93)
<ALLOCATED_TO>	<System>	VC ATSU ATC (PJ.10-93)

[REQ]

Identifier	REQ-10-W2.93-TS-TSM.0002
Title	Local Control of the Systems of the ATSU
Requirement	The ATSU system shall allow the ATSU Supervision to control the systems running at the ATSU, including network connections to the ADSP(s)
Status	<validated>
Rationale	The ATSEP of the ATSU is in charge of managing/controlling all the systems of his ATSU. Such a management remains local to the ATSU (i.e. does not go through ADSP and its provided services).
Category	<Functional>

[REQ Trace]

Relationship	Linked Element Type	Identifier
<ALLOCATED_TO>	<SESAR Solution>	PJ.10-W2-93A PJ.10-W2-93B
<SATISFIES>	< ATMS Requirement>	REQ-PJ.10-W2.93-SPRINTEROP-0046
<ALLOCATED_TO>	<Enabler>	ER APP ATC 215_Management in the VC ATSU of Delegation of ATS Provision between ATUs with Static AoRs in a D-Architecture ER APP ATC 195_Management in the VC ATSU of Delegation of ATS Provision between ATSUs with Static AoRs for Y-Architecture
<ALLOCATED_TO>	<Functional block>	Technical Supervision HMI VC (PJ.10-93) Technical Supervision Voice HMI VC (PJ.10-93)

<ALLOCATED_TO>	<System>	VC ATSU ATC (PJ.10-93)
----------------	----------	------------------------

[REQ]

Identifier	REQ-10-W2.93-TS-TSM.0003
Title	Access to the Status of the Remote ADSP
Requirement	The Technical Supervision Distribution Service shall distribute the status of an ADSP to all relevant remote ATSUs.
Status	<validated>
Rationale	The ATSEP of the ATSU should be aware of the overall status of the ADSP(s) providing data to his ATSU.
Category	<Functional>

[REQ Trace]

Relationship	Linked Element Type	Identifier
<ALLOCATED_TO>	<SESAR Solution>	PJ.10-W2-93A PJ.10-W2-93B
<SATISFIES>	< ATMS Requirement>	REQ-PJ.10-W2.93-SPRINTEROP-0045
<ALLOCATED_TO>	<Enabler>	ER APP ATC 195_Management in the VC ATSU of Delegation of ATS Provision between ATSUs with Static AoRs for Y-Architecture ER APP ATC 217_Management in the ADSP of Delegation of ATS provision between ATUs with Static AoRs in a D-Architecture ER APP ATC 215_Management in the VC ATSU of Delegation of ATS Provision between ATUs with Static AoRs in a D-Architecture ER APP ATC 216_Management in the ADSP of Delegation of ATS provision between ATUs with Static AoRs in a Y-Architecture
<ALLOCATED_TO>	<Functional block>	Technical Supervision HMI VC (PJ.10-93) Technical Supervision ATC (PJ.10-93) Technical Supervision Voice HMI VC (PJ.10-93)
<ALLOCATED_TO>	<Service>	TechnicalSupervisionDistribution (PJ.32-WP3)
<ALLOCATED_TO>	<System>	VC ATSU ATC (PJ.10-93) ADSP Voice (PJ.10-93) ADSP ATC (PJ.10-93)

[REQ]

Identifier	REQ-10-W2.93-TS-TSM.0004
Title	Local Access to the Status of the Systems of an ADSP
Requirement	The ADSP system shall provide to the ADSP Supervision the status of all relevant systems running at the ADSP itself, including network connections to the ATSU(s).
Status	<validated>
Rationale	The ATSEP of the ADSP is in charge of monitoring all the systems of his ADSP. Such a management remains local to the ADSP (i.e. not distributed through its provided services).
Category	<Functional>

[REQ Trace]

Relationship	Linked Element Type	Identifier
<ALLOCATED_TO>	<SESAR Solution>	PJ.10-W2-93A PJ.10-W2-93B
<SATISFIES>	< ATMS Requirement>	REQ-PJ.10-W2.93-SPRINTEROP-0047
<ALLOCATED_TO>	<Enabler>	ER APP ATC 216_Management in the ADSP of Delegation of ATS provision between ATUs with Static AoRs in a Y-Architecture ER APP ATC 217_Management in the ADSP of Delegation of ATS provision between ATUs with Static AoRs in a D-Architecture
<ALLOCATED_TO>	<Functional block>	Technical Supervision ATC (PJ.10-93)
<ALLOCATED_TO>	<System>	ADSP Voice (PJ.10-93) ADSP ATC (PJ.10-93)

[REQ]

Identifier	REQ-10-W2.93-TS-TSM.0005
Title	Local Control of the Systems of the ADSP
Requirement	The ADSP system shall allow the ADSP Supervision to control the systems running at the ADSP itself.
Status	<validated>
Rationale	The ATSEP of the ADSP is in charge of managing/controlling all the systems of his ADSP. Such a management remains local to the ADSP (i.e. is not supported by the ADSP services).
Category	<Functional>

[REQ Trace]

Relationship	Linked Element Type	Identifier
<ALLOCATED_TO>	<SESAR Solution>	PJ.10-W2-93A PJ.10-W2-93B
<SATISFIES>	< ATMS Requirement>	REQ-PJ.10-W2.93-SPRINTEROP-0049
<ALLOCATED_TO>	<Enabler>	ER APP ATC 217_Management in the ADSP of Delegation of ATS provision between ATUs with Static AoRs in a D-Architecture ER APP ATC 216_Management in the ADSP of Delegation of ATS provision between ATUs with Static AoRs in a Y-Architecture
<ALLOCATED_TO>	<Functional block>	Technical Supervision ATC (PJ.10-93)
<ALLOCATED_TO>	<System>	ADSP Voice (PJ.10-93) ADSP ATC (PJ.10-93)

[REQ]

Identifier	REQ-10-W2.93-TS-TSM.0006
Title	Access to the Status of the Remote ATSU
Requirement	The ATSU(s) connected to a given ADSP shall provide their status to this ADSP.
Status	<in progress>
Rationale	The ATSEP of the ADSP should be aware of the overall status of the ATSU(s) fed by his ADSP.
Category	<Functional>

[REQ Trace]

Relationship	Linked Element Type	Identifier
<ALLOCATED_TO>	<SESAR Solution>	PJ.10-W2-93A PJ.10-W2-93B
<SATISFIES>	< ATMS Requirement>	REQ-PJ.10-W2.93-SPRINTEROP-0048
<ALLOCATED_TO>	<Enabler>	ER APP ATC 195_Management in the VC ATSU of Delegation of ATS Provision between ATSU's with Static AoRs for Y-Architecture ER APP ATC 215_Management in the VC ATSU of Delegation of ATS Provision between ATUs with Static AoRs in a D-Architecture

<ALLOCATED_TO>	<System>	VC ATSU ATC (PJ.10-93) ADSP ATC (PJ.10-93) ADSP Voice (PJ.10-93)
----------------	----------	--

[REQ]

Identifier	REQ-10-W2.93-TS-TSM.0007
Title	Inter ADSP Access to the Status of the Other ADSPs
Requirement	The Technical Supervision Distribution Service shall distribute the status of an ADSP to all relevant ADSPs; i.e. between inter-connected ADSPs.
Status	<in progress>
Rationale	The ATSEP of an ADSP should be aware of the overall status of the other ADSP(s) connected to his ADSP.
Category	<Functional>

[REQ Trace]

Relationship	Linked Element Type	Identifier
<ALLOCATED_TO>	<SESAR Solution>	PJ.10-W2-93A PJ.10-W2-93B
<SATISFIES>	<ATMS Requirement>	REQ-PJ.10-W2.93-SPRINTEROP-0050
<ALLOCATED_TO>	<Enabler>	ER APP ATC 197_Management in the ADSP of Delegation of ATS provision between ATSUs with Dynamic AoRs for U-Architecture
<ALLOCATED_TO>	<Functional block>	Technical Supervision ATC (PJ.10-93)
<ALLOCATED_TO>	<Service>	TechnicalSupervisionDistribution (PJ.32-WP3)
<ALLOCATED_TO>	<System>	ADSP Voice (PJ.10-93) ADSP ATC (PJ.10-93)

4.2.1.2 Operational Configuration services (OPCONFM, OPCONFD)

4.2.1.2.1 Service Overview

The **Operational Configuration Management Service (OPCONFM)** allows the ACC/Approach operational supervisor to manage the operational configuration by processing the updates on Operational configuration data related to the operational supervisor inputs regarding the management of the following on-line data:

- the mapping of control roles and responsibilities (control volume, ADES, set of runways,...),
- the Radio Frequency allocation plan,
- the status and timetables of restricted airspace (CDR/ARES),
- the configuration of Aerodromes.

The **Operational Configuration Distribution Service (OPCONF)** supports the distribution of these on-line operational configuration data (except airspace status) to CWP and operational supervisor consumers according to their subscription to the service.

A specific service, the **Airspace Status Distribution Service (ASD)**, is dedicated to the distribution of on-line data regarding the restricted airspace status data and timetables (CDR/ARES). However, as this service is not impacted by the operational requirements stemming from SOL 93 OSED ([37]), the requirements specific to this service are not provided in this document. Only its dependencies with the OPCONFM are addressed.

4.2.1.2.2 Service Assumptions

Assumptions for the environment and other ATM operations are stated in the table below:

Identifier	Assumption	Comment
OPCONF-ASSUMPTION-001	All active CWPs are informed of the changes made to the operational configuration (e.g. through a subscription to the OPCONFD and ASD Services)	For instance, if an Operational Supervisor updates the current configuration mapping, all CWP must be aware of it.
OPCONF-ASSUMPTION-003	All subscribers of the OPCONFD service know the names of the Radio Frequency Plans the ADSP is aware off: these names are off-line defined.	An OPCONFD consumer may request a Radio Frequency Plan for its own ATSU, or for another ATSU (if this plan is known by the ADSP).

Table 14: [OPCONF] Environmental conditions

4.2.1.2.3 Service Dependencies

This section describes dependencies between the OPCONFM, OPCONFD and ASD services.

[REQ]

Identifier	REQ-16-03-TS-OPM.0001
Title	Coordination between OPCONFM and OPCONFD provider
Requirement	The provider of the Operational Configuration Management Service shall ensure co-ordination with the Operational Configuration Distribution service.
Status	<validated>

Rationale	The Operational Configuration Management service does not inherently include data distribution service from the ADSP to the VC ATSU but assumes that the Operational Configuration Distribution service is used instead for that purpose. This requirement ensures the availability of the 2 services.
Category	<Functional>

[REQ Trace]

Relationship	Linked Element Type	Identifier
<ALLOCATED_TO>	<SESAR Solution>	PJ.10-W2-93A PJ.10-W2-93B
<ALLOCATED_TO>	<Enabler>	SVC-022_Provision and Consumption of Operational Configuration Management Service ER APP ATC 184_ATM Data Service Provider for ATC services in a Virtual Centre context ER APP ATC 186_Virtual Centre ATSU
<ALLOCATED_TO>	<Service>	OperationalConfigurationManagement

[REQ]

Identifier	REQ-16-03-TS-OPM.0002
Title	OPCONFD consumer dependency on OPCONFM provider
Requirement	The consumer of the Operational Configuration Management service shall also consume the Operational Configuration Distribution service.
Status	<validated>
Rationale	The Operational Configuration Management service does not inherently include data distribution service from the ADSP to the VC ATSU but assumes that the Operational Configuration Distribution service is used instead for that purpose. This requirement ensures that the Operational Configuration Management service consumer gets informed about the effects of its operations.
Category	<Functional>

[REQ Trace]

Relationship	Linked Element Type	Identifier

<ALLOCATED_TO>	<SESAR Solution>	PJ.10-W2-93A PJ.10-W2-93B
<ALLOCATED_TO>	<Enabler>	SVC-022_Provision and Consumption of Operational Configuration Management Service ER APP ATC 184_ATM Data Service Provider for ATC services in a Virtual Centre context ER APP ATC 186_Virtual Centre ATSU
<ALLOCATED_TO>	<Service>	OperationalConfigurationManagement

[REQ]

Identifier	REQ-16-03-TS-OPM-0003
Title	Coordination between OPCONFM and ASD provider
Requirement	The provider of the Airspace Status management capability of the Operational Configuration Management Service shall ensure co-ordination with the Airspace Status Distribution service.
Status	<validated>
Rationale	The Operational Configuration Management service does not inherently include airspace status data distribution service from the ADSP to the VC ATSU but assumes that the Airspace Status Distribution service is used instead for that purpose. This requirement ensures the availability of the 2 services.
Category	<Functional>

[REQ Trace]

Relationship	Linked Element Type	Identifier
<ALLOCATED_TO>	<SESAR Solution>	PJ.10-W2-93A PJ.10-W2-93B
<ALLOCATED_TO>	<Enabler>	SVC-022_Provision and Consumption of Operational Configuration Management Service ER APP ATC 184_ATM Data Service Provider for ATC services in a Virtual Centre context ER APP ATC 186_Virtual Centre ATSU
<ALLOCATED_TO>	<Service>	OperationalConfigurationManagement

[REQ]

Identifier	REQ-16-03-TS-OPM-0004
Title	ASD consumer dependency on OPCONFM provider
Requirement	The consumer of the Airspace Status management capability through Operational Configuration Management service shall also consume the Airspace Status Distribution service.
Status	<validated>
Rationale	The Operational Configuration Management service does not inherently include airspace status data distribution service from the ADSP to the VC ATSU but assumes that the Airspace status Distribution service is used instead for that purpose. This requirement ensures that the Operational Configuration Management service consumer gets informed about the effects of its operations on airspace status data management.
Category	<Functional>

[REQ Trace]

Relationship	Linked Element Type	Identifier
<ALLOCATED_TO>	<SESAR Solution>	PJ.10-W2-93A PJ.10-W2-93B
<ALLOCATED_TO>	<Enabler>	SVC-022_Provision and Consumption of Operational Configuration Management Service ER APP ATC 184_ATM Data Service Provider for ATC services in a Virtual Centre context ER APP ATC 186_Virtual Centre ATSU
<ALLOCATED_TO>	<Service>	OperationalConfigurationManagement AirspaceStatusDistribution

4.2.1.2.4 Interface Interoperability requirements

The operations and message payloads that the Operational Configuration services provider and consumers need to be compliant with are identified in this section.

[REQ]

Identifier	REQ-16-03-TS-OPM.0005
Title	Support of OPCONFM payload
Requirement	The provider and the consumers of the Operational Configuration Management service shall comply with the message definition specified in 8.1, SDD section 7, "Payload Data Types".

Status	<validated>
Rationale	This requirement ensures that the Operational Configuration Management service provider and service consumers are interoperable at the message level.
Category	<Interface>

[REQ Trace]

Relationship	Linked Element Type	Identifier
<ALLOCATED_TO>	<SESAR Solution>	PJ.10-W2-93A PJ.10-W2-93B
<ALLOCATED_TO>	<Enabler>	SVC-022_Provision and Consumption of Operational Configuration Management Service ER APP ATC 184_ATM Data Service Provider for ATC services in a Virtual Centre context ER APP ATC 186_Virtual Centre ATSU
<ALLOCATED_TO>	<Service>	OperationalConfigurationManagement

[REQ]

Identifier	REQ-16-03-TS-OPM.0006
Title	Support of OPCONFM operations
Requirement	The provider of the Operational Configuration Management service shall provide the consumer with the capability to invoke the operations specified in 8.1, SDD section 5, "Service Interface Specifications".
Status	<validated>
Rationale	This requirement ensures that service producer and service consumers implementing the Operational Configuration Management service are interoperable at the message level.
Category	<Interface>

[REQ Trace]

Relationship	Linked Element Type	Identifier
<ALLOCATED_TO>	<SESAR Solution>	PJ.10-W2-93A PJ.10-W2-93B

<ALLOCATED_TO>	<Enabler>	SVC-022_Provision and Consumption of Operational Configuration Management Service ER APP ATC 184_ATM Data Service Provider for ATC services in a Virtual Centre context ER APP ATC 186_Virtual Centre ATSU
<ALLOCATED_TO>	<Service>	OperationalConfigurationManagement

[REQ]

Identifier	REQ-16-03-TS-OPD.0001
Title	Support of OPCONF payload
Requirement	The provider and the consumers of the Operational Configuration Distribution service shall comply with the message definition specified in 8.2, SDD section 7, "Payload Data Types".
Status	<validated>
Rationale	This requirement ensures that service producer and service consumers implementing the Operational Configuration Distribution service are interoperable at the message level.
Category	<Interface>

[REQ Trace]

Relationship	Linked Element Type	Identifier
<ALLOCATED_TO>	<SESAR Solution>	PJ.10-W2-93A PJ.10-W2-93B
<ALLOCATED_TO>	<Enabler>	SVC-021_Provision and Consumption of Operational Configuration Distribution Service ER APP ATC 184_ATM Data Service Provider for ATC services in a Virtual Centre context ER APP ATC 186_Virtual Centre ATSU
<ALLOCATED_TO>	<Service>	OperationalConfigurationDistribution

[REQ]

Identifier	REQ-16-03-TS-OPD.0002
Title	Support of OPCONF operations

Requirement	The provider of the Operational Configuration Distribution service shall provide the consumer with the capability to invoke the operations specified in 8.2, SDD section 5, “Service Interface Specifications”.
Status	<validated>
Rationale	This requirement ensures that service producer and service consumers implementing the Operational Configuration Distribution service are interoperable at the operation level.
Category	<Interface>

[REQ Trace]

Relationship	Linked Element Type	Identifier
<ALLOCATED_TO>	<SESAR Solution>	PJ.10-W2-93A PJ.10-W2-93B
<ALLOCATED_TO>	<Enabler>	SVC-021_Provision and Consumption of Operational Configuration Distribution Service ER APP ATC 184_ATM Data Service Provider for ATC services in a Virtual Centre context ER APP ATC 186_Virtual Centre ATSU
<ALLOCATED_TO>	<Service>	OperationalConfigurationDistribution

4.2.1.2.5 Dynamic Behaviour requirements

4.2.1.2.5.1 Reference Behaviour Scenarios

4.2.1.2.5.1.1 Manage and Publish Sector Mapping

In order to facilitate the understanding of the dynamic behaviour for the management of sector mappings, some definitions and principles are presented as an introduction.

Main Definitions

[Logical CWP]

A Logical CWP is defined as a list of Responsibilities (e.g. control sectors, set of STARS, ...) and an associated role (“Tactical”, “Planner”, ...). It is used to define the set of control Responsibilities (e.g. control sectors “S1”, “S2”, “S3”) to be managed by this role (e.g. “Tactical”) on a controller working position.

A Responsibility cannot be mapped to more than one Logical CWP for the same role.

Off-line defined parameters identify which Logical CWP is mapped to which actual “physical” CWP.

[Sector Mapping]

The Sector Mapping is defined as a list of Logical CWPs and the composition of each Logical CWP in terms of Role and Responsibilities. It is associated to a given ATSU Sector Configuration. In operational terms, the Sector Mapping corresponds to the need of identifying which sectors are to

be controlled on each active CWP by a controller with a specific Role (Tactical, Planner, ...) at a given time in the ATSU (or in an ATSU partition).

Two types of Sector Mappings can be defined:

- the *currentSectorMapping*: it is the only one which is currently active for an ATSU Sector Configuration (assignment of roles/sectors on the CWPs currently used in the operational room managed by the supervisor).
- the *nextSectorMapping*: it is a mapping planned to be applied as current configuration in the future. Only one Sector Mapping can be defined as next at a given time for an ATSU Sector Configuration.

[ATSU Sector Configuration]

For each ATSU Sector Configuration, the *currentSectorMapping*, and possibly a *nextSectorMapping*, are defined.

Generally, only one ATSU Sector Configuration is defined to cover the entire AoR of the ATSU. However, more than one ATSU Sector Configuration can be defined if needed, for instance if different qualification areas exist for this AoR: it allows different Sector Mappings to be managed independently for each part of the AoR (but of course, these different Sector Configurations must cover the whole AoR, and not overlap).

ATSU Sector Configurations are defined off-line and cannot be updated on-line. Each Sector Mapping refers to a given ATSU Sector Configuration (unless only one is defined for the ATSU, in which case it can be omitted).

Main principles for Sector Configuration

The AoR of an ATSU can be configured using only one global Sector Configuration. Alternatively, 2 or more Sector Configurations can be used to configure different parts of the AoR (generally, areas for which ATCOs need different qualifications, e.g. north and south of the ATSU AoR). Of course, these different Sector Configurations must cover the whole AoR, and not overlap.

For each sector configuration, the active sector mapping is called the *currentSectorMapping*. The sector mapping that is to be activated next is called the *nextSectorMapping*.

There is also a possibility to use *pre-defined* sector mappings as a basis for current or next Sector Mappings. The *pre-definedSectorMappings* are defined off-line.

To change the *currentSectorMapping*, the OPCONFM service offers the possibility to:

- update it directly,
- activate the *nextSectorMapping*, which then becomes the current one (in this case, there is no *nextSectorMapping* anymore), or
- activate a *pre-definedSectorMapping*.

The update of a sector mapping consists of:

- the update of the list of open Logical CWPs for this Sector Mapping,
- and/or the update list of Responsibilities (e.g. sectors) and the Role (e.g. "Tactical") associated to each Logical CWP of the Sector Mapping.

Operationally, it is the way to group/de-group sectors on a position.

To create the *next* Sector Mapping (if there is none), it is possible to load a *pre-defined* Sector Mapping. To change this *next* Sector Mapping later, the update can be made directly, or by loading another *pre-defined* Sector Mapping.

The *next* Sector Mapping can be deleted, but not the *current* Sector Mapping.

Finally, the OPCONFM service offers the possibility to revert the *current* Sector Mapping to the *pre-defined* default one (for instance, when preparing a training).

Each time that an ATSU Sector Configuration is updated, the Operational configuration Distribution Service publishes its *current* and/or *next* Sector Mappings to the subscribers, depending to their subscription parameters.

It is also possible to request an ATSU Sector Configuration, i.e. get its *current* and *next* Sector Mappings.

This scenario illustrates the process of an operational configuration change triggered by a supervisor request.

Pre-conditions:

- The following off-line environment data are available for each SectorConfiguration of the ATSU: the compatibility rules between roles and responsibilities, the predefined mappings (including the default one).
- Each sectorConfiguration has been initialized for this ATSU: there is a current mapping activated.
- CWP and OPSUPWP have subscribed to the sector configuration changes distribution and management (for the OPSUPWP).
- the sector S1 is mapped on LogicalCWP1.
- the sector S2 is mapped on LogicalCWP2.
- The operational supervisor wants to group the control responsibilities (sectors here) S1 and S2 on the LogicalCWP1.

- T0: OPSUPWP launches the sector configuration change and receives an OK answer to the transaction.

- T1: OPSUPWP, LogicalCWP1 and LogicalCWP2 are updated with the new sectorisation. S1 and S2 are grouped on LogicalCWP1 (controlled by "CWP"). S2 is no longer mapped on LogicalCWP2.

Assumption:

When a sector mapping is updated:

- either the corresponding radio frequency allocation plan is supposed to be consistent at any time with this update of the sectorisation (limitation or checks during the update process),
- or there is a redistribution in parallel of the corresponding radio frequency allocation plan.

Note: "Internal coordination" can represent a coordination between 2 different ADSPs, in this case this could require the use of a specific distribution service.

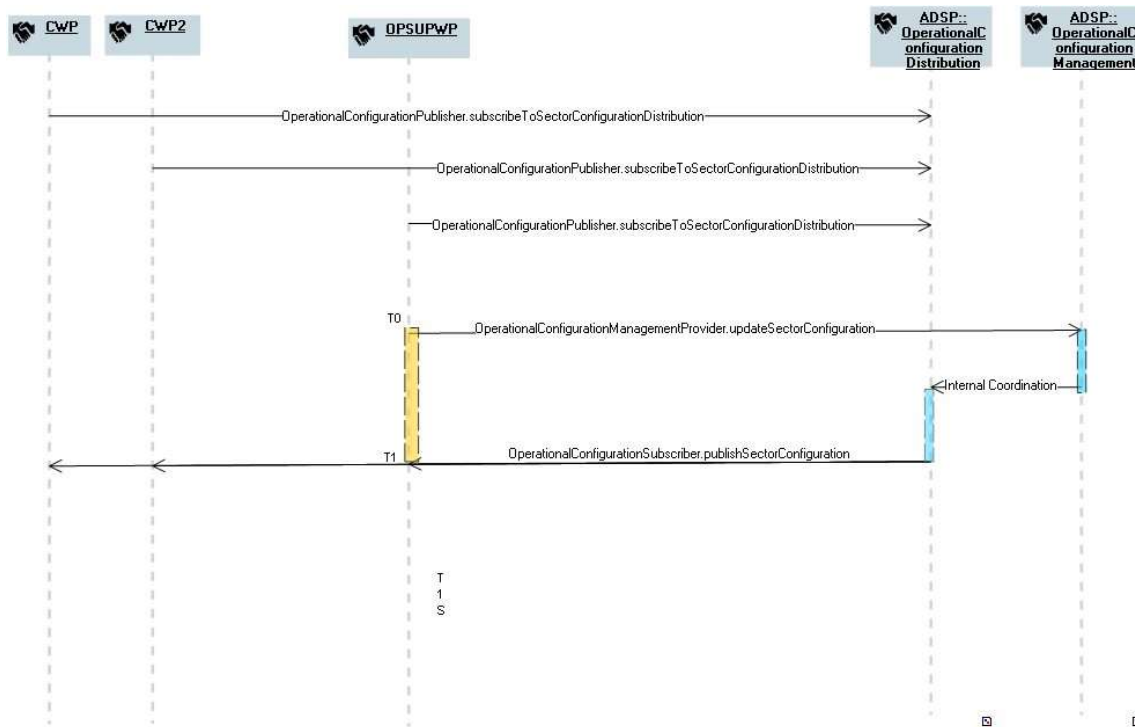

Figure 14: [OPCONFM/D] Reference Behaviour for Management of Sector Mapping

4.2.1.2.5.1.2 Get Sector Mappings

Notation:

- getSectorConfiguration(sectorConfigurationName).
- ATSUSectorConfiguration(sectorConfigurationName; sectorMappingName,sectorMappingState, mappedLogicalCWPs).

Pre-conditions:

- Each ATSUSectorConfiguration has been initialized for this ATSU.
- The OPSUPWP has subscribed to the OPSUP Distribution service.

Sequence:

- T1: The operational supervisor selects a sectorConfiguration to get all its sectorMappings by using the "getSectorConfiguration" operation of the service interface "SectorConfigurationProvider".
- The OPSUPWP originator of the input receives synchronously in return the dynamic data related to the current and next mappings of the requested ATSUSectorConfiguration.

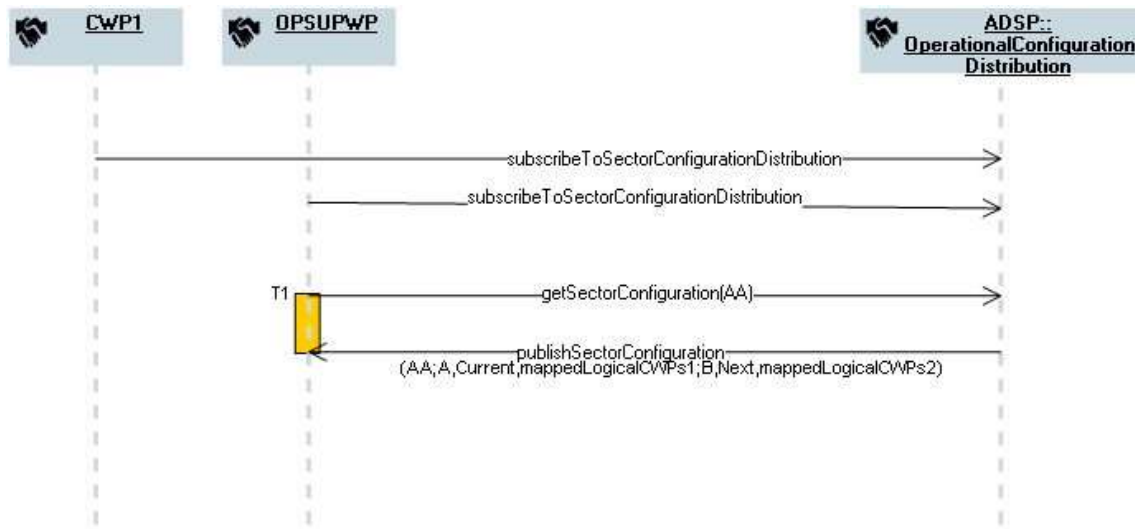

Figure 15: [OPCONFM/D] Reference Behaviour for Get Sector Configuration

4.2.1.2.5.1.3 Manage and publish Radio Frequency Allocation

This scenario illustrates the process of a frequency allocation change triggered by a supervisor request.

Pre-conditions:

- Radio frequency data are off-line defined for each ATSUConfiguration of the ATSU:
 - ☐☐ the list of responsibilities requiring radio frequency allocation,
 - ☐☐ the list of radio frequencies available for the allocation,
 - ☐☐ the list of predefined radio frequencies allocation plans (including the default one).
- The ATSUConfiguration has been initialised: there is a current frequency allocation plan activated.
- The LogicalCWP and the OPSUPWP have subscribed to the radio frequency configuration changes distribution and management (for the OPSUPWP only).
- The OPSUPWP originator is off-line associated to the ATSUConfiguration allowed to modify this radio frequency (off-line defined).
- The operational supervisor wants to allocate the frequency F1 to the responsibility R1.
- F1 and R1 belong to the same ATSUConfiguration.
- F1 belongs to the predefined available radio frequencies.
- R1 belongs to the predefined responsibilities requiring radio frequency allocation.

- T0: The supervisor (OPSUPWP) assigned the radio frequency F1 to the responsibility R1 in the current allocation plan of the considered ATSUConfiguration. He receives an OK answer to the transaction.

- T1: OPSUPWP and LogicalCWP receive the updated frequency allocation plan.

- T2: The supervisor (OPSUPWP) launches a frequency allocation change by selecting an other radio frequency allocation plan among the predefined radio frequency configurations. He receives an OK answer to the transaction.

- T3: OPSUPWP and LogicalCWP receive the new applicable frequency allocation plan.

Assumptions:

- After performing the request, the following rule is satisfied: every responsibility defined in the current radio frequencies allocation plan has one and only one radio frequency.
- When the current radio frequency allocation plan is updated:
 - either the corresponding sector mappings are supposed to be consistent at any time with this update of the frequency allocation (limitation or checks during the update process),
 - or there is a redistribution in parallel of the concerned sector mappings.
- The SFPL include no direct reference to Frequencies, but only reference to responsibilities.
- Allocation of Frequencies to Responsibilities are stored and made available to generic clients. Controllers will know the radio frequencies allocation plan applying on their own ATSU as well as radio frequencies allocation plans of non-controlled ATSU which have off-line defined radio frequencies allocation plans.

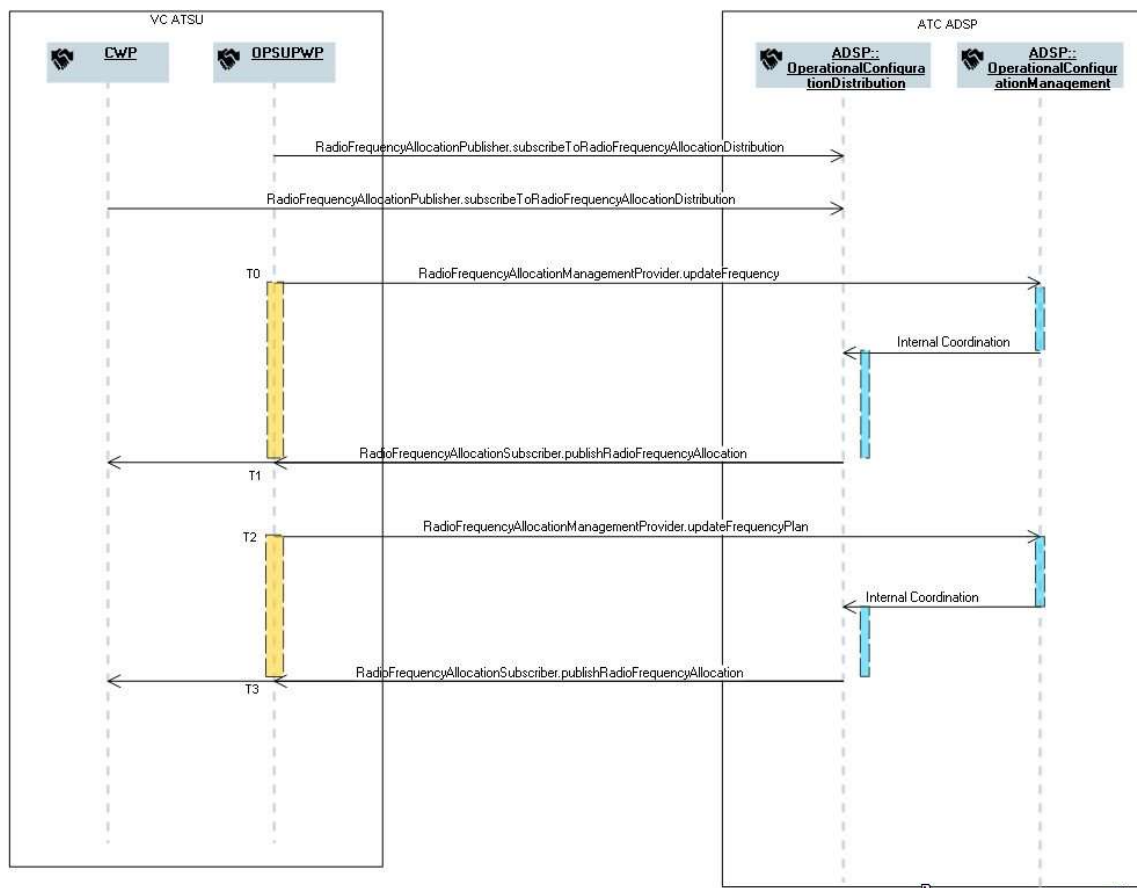

Figure 16: [OPCONFM/D] Reference Behaviour for Management of Radio Frequency Allocation

4.2.1.2.5.1.4 Manage and Publish Aerodrome Configurations

In order to facilitate the understanding of the dynamic behaviour for the management of Aerodrome Configurations, some definitions are presented as an introduction.

Pre-conditions on off-line parameters:

The CWPs and OPSUP have subscribed to the Aerodrome Group Configuration data

(SubscribeToAerodromeConfigurationDistribution operation).

The aerodrome groups and the predefined aerodrome group configurations are defined in the off-line parameters:

- Two aerodrome groups are off-line defined: AGA and LBBB
- AGA groups the LAAA and LZZZ Aerodromes
- LBBB groups only the LBBB Aerodrome (so the aerodrome group has been given the same name as the Aerodrome)

Aerodrome Group	Aerodrome	Runway
AGA	LAAA	08
	LAAA	26
	LZZZ	24
	LZZZ	06
LBBB	LBBB	09L
	LBBB	27R
	LBBB	9R
	LBBB	27L

Aerodrome Group	Predefined Configurations	Runways	Operating Mode
AGA	Conf1 (default)	08	Landing
		26	Takeoff
		24	Closed
		06	Closed
	Conf2	08	Takeoff
		26	Landing
		24	Landing
		06	Takeoff
	Conf3	08	Mixed
		26	Closed
		24	Mixed
		06	Closed
LBBB	Conf4 (default)	27L	Mixed
		27R	Mixed
		09L	Takeoff
		09R	Takeoff

IAPs are defined in the off-line parameters

IAPs	Associated IAF	Runways
IAP1	IAF1	08
IAP2	IAF2	08
IAP3	IAF3	26
IAP4	IAF4	26

IAP5	IAF5	26
------	------	----

Current context for AerodromeGroupConfigurations:

The current Aerodrome Group Configuration is Conf1 for the AGA Aerodrome Group

The current Aerodrome Group Configuration is Conf4 for the LBBB Aerodrome Group

Use Cases acting on Aerodrome of an Aerodrome Group

Use Case: transition level modification of the LAAA Aerodrome

1/ The Operational Supervisor selects LAAA and modifies its transitionLevel

2/ The ADSP applies the requested changes on the current Aerodrome Group Configuration

applicable to LBBB (Conf4): modifyAerodromeConfiguration (AGA,LAAA,Level)

and publishes the updated LBBB Aerodrome Group Configuration information:

publishAerodromeGroupConfiguration.

Use Cases related to on-line modifications of the Runways of an Aerodrome Group

Use Case: modification of the runway statuses of LBBB Aerodrome

1/ The Operational Supervisor selects the 09R and 09L runway of LBBB Aerodrome and then modifies their status.

2/ The ADSP applies the requested changes on the current Aerodrome Group Configuration

applicable to LBBB (Conf4): modifyRunwayConfiguration (LBBB,LBBB,09R,"CLOSE", 09L,"CLOSE")

and publishes the updated LBBB Aerodrome Group Configuration information:

publishAerodromeGroupConfiguration.

Use Case: IAP in operation modification of 08 runway

1/ The Operational Supervisor selects the 08 runway of LAAA aerodrome, then select IAP1 as the new IAP in operation for IAF1.

2/ The ADSP applies the requested changes on the current Aerodrome Group Configuration

applicable to LAAA (Conf1): modifyRunwayConfiguration (AGA,LAAA,08,"IAP1","IAF1")

and publishes the updated AGA Aerodrome Group Configuration information:

publishAerodromeGroupConfiguration.

Use Cases related to on-line modifications of the configuration of the AGA Aerodrome Group

Use Case: Update the current aerodrome group configuration in order to cope with increase of traffic

1/ The Operational Supervisor selects AGA Aerodrome Group in order to change its current configuration then selects Conf2

2/ The ADSP uploads Conf2 as the current configuration for AGA Aerodrome Group:

activateAerodromeGroupConfiguration (AGA, Conf2)

and publishes the updated AGA Aerodrome Group Configuration information:

publishAerodromeGroupConfiguration (AGA,LZZZ,24,OPEN,Landing, 06,OPEN,Takeoff).

Use Case: Select the next Aerodrome Group Configuration

1/ The Operational Supervisor selects AGA Aerodrome Group then selects predefined Conf3 as the Next {aerodrome group configuration.}

2/ The ADSP records Conf3 as the Next configuration to be applied for AGA Aerodrome Group:

selectNextAerodromeGroupConfiguration (AGA, Conf3, 1545264000)

and publishes the updated AGA Aerodrome Group Configuration information:

publishAerodromeGroupConfiguration.

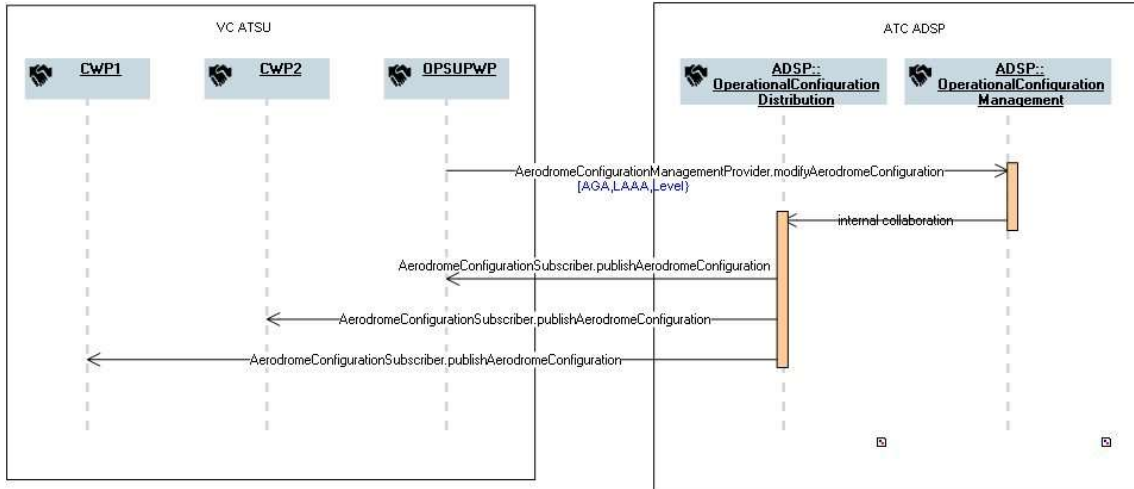

Figure 17: [OPCONFM] Reference behaviour Aerodrome Group Configuration Management and Distribution

4.2.1.2.5.2 OPCONFM requirements

4.2.1.2.5.2.1 Requirements update and deletion of Sector Mappings

An example scenario where these requirements are applicable is illustrated in section 4.2.1.2.5.1.1, which also contains some definitions helping the reading of these requirements.

[REQ]

Identifier	REQ-16-03-TS-OPM.0007
Title	Processing the request to update a Sector Mapping
Requirement	Upon reception of an update request of the current or next Sector Mapping for an ATSU Sector Configuration, the OPCONFM service provider shall update this mapping as requested.
Status	<validated>
Rationale	This requirement specifies the actions of the OPCONFM service provider when receiving a Sector Mapping update request. The resulting ATSU Sector Configuration is advertised through the OPCONFD service.
Category	<Functional>

[REQ Trace]

Relationship	Linked Element Type	Identifier
--------------	---------------------	------------

<ALLOCATED_TO>	<SESAR Solution>	PJ.10-W2-93A PJ.10-W2-93B
<SATISFIES>	< ATMS Requirement>	REQ-PJ.10-W2-93-SPRINTEROP-IER.0001
<ALLOCATED_TO>	<Enabler>	SVC-022_Provision and Consumption of Operational Configuration Management Service ER APP ATC 184_ATM Data Service Provider for ATC services in a Virtual Centre context ER APP ATC 186_Virtual Centre ATSU
<ALLOCATED_TO>	<Service>	OperationalConfigurationManagement

[REQ]

Identifier	REQ-16-03-TS-OPM.0008
Title	Checking of Sector Mapping state before deletion
Requirement	Upon reception of a deletion request on a Sector Mapping, the OPCONFM service provider shall reject the request if this Sector Mapping is in the state “current”.
Status	<in progress>
Rationale	An active mapping must be defined at any time, so current mappings cannot be deleted.
Category	<Functional>

[REQ Trace]

Relationship	Linked Element Type	Identifier
<ALLOCATED_TO>	<SESAR Solution>	PJ.10-W2-93A PJ.10-W2-93B
<ALLOCATED_TO>	<Enabler>	SVC-022_Provision and Consumption of Operational Configuration Management Service ER APP ATC 184_ATM Data Service Provider for ATC services in a Virtual Centre context ER APP ATC 186_Virtual Centre ATSU
<ALLOCATED_TO>	<Service>	OperationalConfigurationManagement

[REQ]

Identifier	REQ-16-03-TS-OPM.0009
------------	-----------------------

Title	Deletion of a Sector Mapping
Requirement	Upon reception of a deletion request on a Sector Mapping in the state “next”, the OPCONFM service provider shall delete this Sector Mapping from the ATSU Sector Configuration.
Status	<in progress>
Rationale	This requirement specifies the actions of the OPCONFM service provider when receiving a Sector Mapping delete request. The resulting ATSU Sector Configuration is advertised through the OPCONFD service.
Category	<Functional>

[REQ Trace]

Relationship	Linked Element Type	Identifier
<ALLOCATED_TO>	<SESAR Solution>	PJ.10-W2-93A PJ.10-W2-93B
<ALLOCATED_TO>	<Enabler>	SVC-022_Provision and Consumption of Operational Configuration Management Service ER APP ATC 184_ATM Data Service Provider for ATC services in a Virtual Centre context ER APP ATC 186_Virtual Centre ATSU
<ALLOCATED_TO>	<Service>	OperationalConfigurationManagement

[REQ]

Identifier	REQ-16-03-TS-OPM.0010
Title	Implicit deletion of next Sector Mapping
Requirement	Upon reception of a deletion request identifying no particular mapping for the ATSU Sector Configuration, the OPCONFM service provider shall: <ul style="list-style-type: none"> • delete the associated next Sector Mapping from the ATSU Sector Configuration, or • reject the request if there is none.
Status	<in progress>
Rationale	There can be only zero or one Sector Mapping with the state “next” for a given ATSU Sector Configuration.
Category	<Functional>

[REQ Trace]

Relationship	Linked Element Type	Identifier
<ALLOCATED_TO>	<SESAR Solution>	PJ.10-W2-93A PJ.10-W2-93B
<ALLOCATED_TO>	<Enabler>	SVC-022_Provision and Consumption of Operational Configuration Management Service ER APP ATC 184_ATM Data Service Provider for ATC services in a Virtual Centre context ER APP ATC 186_Virtual Centre ATSU
<ALLOCATED_TO>	<Service>	OperationalConfigurationManagement

4.2.1.2.5.2.2 Requirements for activation of Sector Mappings

An example scenario where these requirements are applicable is illustrated in section 4.2.1.2.5.1.1.

[REQ]

Identifier	REQ-16-03-TS-OPM.0011
Title	Activation of the next Sector Mapping
Requirement	<p>Upon reception of a request to activate the next Sector Mapping, the OPCONFM service provider shall update the ATSU Sector Configuration as follows:</p> <ul style="list-style-type: none"> • Replace the current Sector Mapping with the next Sector Mapping (which now takes the status “current”), and • Remove the next Sector Mapping.
Status	<validated>
Rationale	<p>This requirement specifies the actions of the OPCONFM service provider when receiving a request to activate the next sector mapping.</p> <p>The resulting ATSU Sector Configuration is advertised through the OPCONFD service.</p>
Category	<Functional>

[REQ Trace]

Relationship	Linked Element Type	Identifier

<ALLOCATED_TO>	<SESAR Solution>	PJ.10-W2-93A PJ.10-W2-93B
<SATISFIES>	< ATMS Requirement>	REQ-PJ.10-W2.93-SPRINTEROP-IER.0001
<ALLOCATED_TO>	<Enabler>	SVC-022_Provision and Consumption of Operational Configuration Management Service ER APP ATC 184_ATM Data Service Provider for ATC services in a Virtual Centre context
<ALLOCATED_TO>	<Service>	OperationalConfigurationManagement

[REQ]

Identifier	REQ-16-03-TS-OPM.0012
Title	Activation of pre-defined Sector Mappings
Requirement	Upon reception of a valid request to activate a pre-defined Sector Mapping, the OPCODE service provider shall replace the current Sector Mapping of the ATSU Sector Configuration with this pre-defined Sector Mapping (which now takes the status “current”). <i>Note: the “original” pre-defined Sector Mapping is not deleted.</i>
Status	<validated>
Rationale	This requirement specifies the actions of the OPCODE service provider when receiving a request to activate a pre-defined sector mapping. The resulting ATSU Sector Configuration is advertised through the OPCODE service.
Category	<Functional>

[REQ Trace]

Relationship	Linked Element Type	Identifier
<ALLOCATED_TO>	<SESAR Solution>	PJ.10-W2-93A PJ.10-W2-93B
<SATISFIES>	< ATMS Requirement>	REQ-PJ.10-W2.93-SPRINTEROP-IER.0001
<ALLOCATED_TO>	<Enabler>	ER APP ATC 184_ATM Data Service Provider for ATC services in a Virtual Centre context ER APP ATC 186_Virtual Centre ATSU

		SVC-022_Provision and Consumption of Operational Configuration Management Service
<ALLOCATED_TO>	<Service>	OperationalConfigurationManagement

[REQ]

Identifier	REQ-16-03-TS-OPM.0013
Title	Revert to default Sector Mapping
Requirement	Upon reception of an activation request asking to revert to the default Sector Mapping, the OPCONFM service provider shall replace the current Sector Mapping of the ATSU Sector Configuration with the off-line pre-defined default Sector Mapping (which takes the status “current”).
Status	<in progress>
Rationale	This requirement specifies the actions of the OPCONFM service provider when receiving a request to revert to the default sector mapping. The resulting ATSU Sector Configuration is advertised through the OPCONFM service.
Category	<Functional>

[REQ Trace]

Relationship	Linked Element Type	Identifier
<ALLOCATED_TO>	<SESAR Solution>	PJ.10-W2-93A PJ.10-W2-93B
<ALLOCATED_TO>	<Enabler>	SVC-022_Provision and Consumption of Operational Configuration Management Service ER APP ATC 184_ATM Data Service Provider for ATC services in a Virtual Centre context ER APP ATC 186_Virtual Centre ATSU
<ALLOCATED_TO>	<Service>	OperationalConfigurationManagement

4.2.1.2.5.2.3 Requirements for loading of next Sector Mappings

An example scenario where these requirements are applicable is illustrated in section 4.2.1.2.5.1.1.

[REQ]

Identifier	REQ-16-03-TS-OPM.0014
Title	Loading of next Sector Mapping
Requirement	<p>Upon reception of a request to load a pre-defined Sector Mapping as the next Sector Mapping, the OPCONFM service provider shall create or replace the next Sector Mapping of the ATSU Sector Configuration with this pre-defined Sector Mapping (which now takes the status “next”).</p> <p><i>Note: the “original” pre-defined Sector Mapping is not deleted.</i></p>
Status	<in progress>
Rationale	<p>This requirement specifies the actions of the OPCONFM service provider when receiving a request to load a next sector mapping.</p> <p>The resulting ATSU Sector Configuration is advertised through the OPCONFD service.</p>
Category	<Functional>

[REQ Trace]

Relationship	Linked Element Type	Identifier
<ALLOCATED_TO>	<SESAR Solution>	PJ.10-W2-93A PJ.10-W2-93B
<ALLOCATED_TO>	<Enabler>	SVC-022_Provision and Consumption of Operational Configuration Management Service ER APP ATC 184_ATM Data Service Provider for ATC services in a Virtual Centre context ER APP ATC 186_Virtual Centre ATSU
<ALLOCATED_TO>	<Service>	OperationalConfigurationManagement

4.2.1.2.5.2.4 Requirements for managing preview/operational mode

[REQ]

Identifier	REQ-10-W2.93-TS-OPM.0035
Title	Switch from Preview to Operational Mode
Requirement	<p>Upon reception of a request for switching from preview mode to operational mode for a list of sectors of a list of CWPs, the OPCONFM service provider shall update the associated preview and allocated responsibilities accordingly.</p>
Status	<in progress>

Rationale	This requirement specifies the actions of the OPCONFM service provider when receiving a request for switching CWP mode.
Category	<Functional>

[REQ Trace]

Relationship	Linked Element Type	Identifier
<ALLOCATED_TO>	<SESAR Solution>	PJ.10-W2-93A PJ.10-W2-93B
<SATISFIES>	<ATMS Requirement>	REQ-PJ.10-W2-93-SPRINTEROP-IER.0005
<ALLOCATED_TO>	<Enabler>	SVC-050_Operational Configuration Management of Working Position Preview Mode, and Neighbouring ATSU Sectors for ATM Service Delegation
<ALLOCATED_TO>	<Functional block>	Operational Supervision Data Management ER/APP ATC (PJ.10-93)

[REQ]

Identifier	REQ-10-W2.93-TS-OPM.0036
Title	Switch from Operational to Preview Mode
Requirement	Upon reception of a request for switching from operational mode to preview mode for a list of sectors of a list of CWPs, the OPCONFM service provider shall update the associated preview and allocated responsibilities accordingly.
Status	<in progress>
Rationale	This requirement specifies the actions of the OPCONFM service provider when receiving a request for switching CWP mode.
Category	<Functional>

[REQ Trace]

Relationship	Linked Element Type	Identifier
<ALLOCATED_TO>	<SESAR Solution>	PJ.10-W2-93A PJ.10-W2-93B
<SATISFIES>	<ATMS Requirement>	REQ-PJ.10-W2-93-SPRINTEROP-IER.0005
<ALLOCATED_TO>	<Enabler>	SVC-050_Operational Configuration Management of Working Position Preview Mode, and Neighbouring ATSU Sectors for ATM Service Delegation

<ALLOCATED_TO>	<Functional block>	Operational Supervision Data Management ER/APP ATC (PJ.10-93)
----------------	--------------------	--

[REQ]

Identifier	REQ-10-W2.93-TS-OPM.0037
Title	Cancel Preview Mode
Requirement	Upon reception of a request for cancelling preview mode for a list of sectors of a list of CWPs, the OPCONFM service provider shall update the associated preview responsibilities accordingly.
Status	<in progress>
Rationale	This requirement specifies the actions of the OPCONFM service provider when receiving a request for cancelling preview mode on working positions.
Category	<Functional>

[REQ Trace]

Relationship	Linked Element Type	Identifier
<ALLOCATED_TO>	<SESAR Solution>	PJ.10-W2-93A PJ.10-W2-93B
<SATISFIES>	< ATMS Requirement>	REQ-PJ.10-W2.93-SPRINTEROP-IER.0004
<ALLOCATED_TO>	<Enabler>	SVC-050_Operational Configuration Management of Working Position Preview Mode, and Neighbouring ATSU Sectors for ATM Service Delegation
<ALLOCATED_TO>	<Functional block>	Operational Supervision Data Management ER/APP ATC (PJ.10-93)

[REQ]

Identifier	REQ-10-W2.93-TS-OPM.0038
Title	Set Preview Mode
Requirement	Upon reception of a request for setting preview mode to a list of sectors of a list of CWPs, the OPCONFM service provider shall update the associated preview responsibilities accordingly.
Status	<in progress>
Rationale	This requirement specifies the actions of the OPCONFM service provider when receiving a request for setting a CWP in preview mode.
Category	<Functional>

[REQ Trace]

Relationship	Linked Element Type	Identifier
<ALLOCATED_TO>	<SESAR Solution>	PJ.10-W2-93A PJ.10-W2-93B
<SATISFIES>	< ATMS Requirement>	REQ-PJ.10-W2-93-SPRINTEROP-IER.0002
<ALLOCATED_TO>	<Enabler>	SVC-050_Operational Configuration Management of Working Position Preview Mode, and Neighbouring ATSU Sectors for ATM Service Delegation
<ALLOCATED_TO>	<Functional block>	Operational Supervision Data Management ER/APP ATC (PJ.10-93)

4.2.1.2.5.2.5 Requirements for updating a frequency or a frequency plan

An example scenario where these requirements are applicable is illustrated in section 4.2.1.2.5.1.3.

[REQ]

Identifier	REQ-16-03-TS-OPM.0015
Title	Update of a radio frequency
Requirement	Upon reception of a radio frequency update request for a list of Control Responsibilities of an ATSU Sector Configuration, the OPCONFM service provider shall update the associated current radio frequency allocation plan accordingly.
Status	<in progress>
Rationale	This requirement specifies the actions of the OPCONFM service provider when receiving a request to update the radio frequency assignment on some Control Responsibilities. The resulting ATSU Frequency Plan is advertised through the OPCONFD service.
Category	<Functional>

[REQ Trace]

Relationship	Linked Element Type	Identifier
<ALLOCATED_TO>	<SESAR Solution>	PJ.10-W2-93A

		PJ.10-W2-93B
<SATISFIES>	< ATMS Requirement>	REQ-PJ.10-W2.93-SPRINTEROP-IER.0001
<ALLOCATED_TO>	<Enabler>	SVC-022_Provision and Consumption of Operational Configuration Management Service ER APP ATC 184_ATM Data Service Provider for ATC services in a Virtual Centre context ER APP ATC 186_Virtual Centre ATSU
<ALLOCATED_TO>	<Service>	OperationalConfigurationManagement

[REQ]

Identifier	REQ-16-03-TS-OPM.0016
Title	Revert to default frequency
Requirement	Upon reception of an update request asking to revert to the default values of the assigned radio frequencies for a list of Control Responsibilities of an ATSU Sector Configuration, the OPCONFM service provider shall update the associated current radio frequency allocation plan accordingly. <i>Note: the default frequency associated to each Control Responsibility is pre-defined off-line.</i>
Status	<in progress>
Rationale	This requirement specifies the actions of the OPCONFM service provider when receiving a request to revert to the default values of the assigned radio frequencies for a list of Control Responsibilities of an ATSU Sector Configuration. The resulting ATSU Frequency Plan is advertised through the OPCONFD service.
Category	<Functional>

[REQ Trace]

Relationship	Linked Element Type	Identifier
<ALLOCATED_TO>	<SESAR Solution>	PJ.10-W2-93A PJ.10-W2-93B
<ALLOCATED_TO>	<Enabler>	SVC-022_Provision and Consumption of Operational Configuration Management Service ER APP ATC 184_ATM Data Service Provider for ATC services in a Virtual Centre context

		ER APP ATC 186_Virtual Centre ATSU
<ALLOCATED_TO>	<Service>	OperationalConfigurationManagement

[REQ]

Identifier	REQ-16-03-TS-OPM.0017
Title	Update of a frequency plan
Requirement	Upon reception of a request to update the current radio frequency allocation of an ATSU Sector Configuration with a given frequency allocation plan pre-defined off-line, the OPCONFM service provider shall replace the current radio frequency allocation with this pre-defined frequency allocation plan.
Status	<in progress>
Rationale	This requirement specifies the actions of the OPCONFM service provider when receiving a request to update the radio frequency plan associated to an ATSU Sector Configuration. The resulting ATSU Frequency Plan is advertised through the OPCONFD service.
Category	<Functional>

[REQ Trace]

Relationship	Linked Element Type	Identifier
<ALLOCATED_TO>	<SESAR Solution>	PJ.10-W2-93A PJ.10-W2-93B
<SATISFIES>	< ATMS Requirement>	REQ-PJ.10-W2.93-SPRINTEROP-IER.0001
<ALLOCATED_TO>	<Enabler>	SVC-022_Provision and Consumption of Operational Configuration Management Service ER APP ATC 184_ATM Data Service Provider for ATC services in a Virtual Centre context ER APP ATC 186_Virtual Centre ATSU
<ALLOCATED_TO>	<Service>	OperationalConfigurationManagement

[REQ]

Identifier	REQ-16-03-TS-OPM.0018
Title	Revert to the default frequency plan

Requirement	<p>Upon reception of a request to revert to the default frequency allocation plan for an ATSU Sector Configuration, the OPCONFM service provider shall replace the current radio frequency allocation with this default frequency allocation plan.</p> <p><i>Note: the default frequency allocation plan for each ATSU Sector Configuration is pre-defined off-line.</i></p>
Status	<in progress>
Rationale	<p>This requirement specifies the actions of the OPCONFM service provider when receiving a request to revert to the default frequency allocation plan associated to an ATSU Sector Configuration.</p> <p>The resulting ATSU Frequency Plan is advertised through the OPCONFD service.</p>
Category	<Functional>

[REQ Trace]

Relationship	Linked Element Type	Identifier
<ALLOCATED_TO>	<SESAR Solution>	PJ.10-W2-93A PJ.10-W2-93B
<ALLOCATED_TO>	<Enabler>	SVC-022_Provision and Consumption of Operational Configuration Management Service ER APP ATC 184_ATM Data Service Provider for ATC services in a Virtual Centre context ER APP ATC 186_Virtual Centre ATSU
<ALLOCATED_TO>	<Service>	OperationalConfigurationManagement

[REQ]

Identifier	REQ-16-03-TS-OPM.0019
Title	Checks performed on radio frequency or radio frequency plans updates

Requirement	<p>Upon reception of a radio frequency update request or a radio frequency plan update, the OPCONFM service provider shall check that the resulting frequency plan respects the following:</p> <ul style="list-style-type: none"> • every Control Responsibility has one and only one associated radio frequency, • every radio frequency belongs to the pre-defined list of radio frequencies available for allocation, • every Control Responsibility belongs to the pre-defined list of Control Responsibility requiring radio frequency allocation.
Status	<in progress>
Rationale	<p>This requirement specifies the checks to be performed by the OPCONFM service provider when receiving a request to update a radio frequency assignment or the radio frequency plan.</p> <p>The resulting ATSU Frequency Plan is advertised through the OPCONFD service.</p> <p>The pre-defined list of radio frequencies available for allocation and the pre-defined list of Control Responsibility requiring radio frequency allocation are defined off-line.</p>
Category	<Functional>

[REQ Trace]

Relationship	Linked Element Type	Identifier
<ALLOCATED_TO>	<SESAR Solution>	PJ.10-W2-93A PJ.10-W2-93B
<SATISFIES>	< ATMS Requirement>	REQ-PJ.10-W2.93-SPRINTEROP-IER.0001
<ALLOCATED_TO>	<Enabler>	SVC-022_Provision and Consumption of Operational Configuration Management Service ER APP ATC 184_ATM Data Service Provider for ATC services in a Virtual Centre context ER APP ATC 186_Virtual Centre ATSU
<ALLOCATED_TO>	<Service>	OperationalConfigurationManagement

4.2.1.2.5.2.6 Requirements for updating restricted airspace timetables

[REQ]

Identifier	REQ-16-03-TS-OPM.0020
Title	Creation of a timesheet for a restricted airspace
Requirement	Upon reception of a request to create a new timesheet for a restricted airspace (ARES or CDR), an OPCONFM service provider shall add this timesheet to the timetable of the restricted airspace.
Status	<in progress>
Rationale	This requirement specifies the actions of the OPCONFM service provider when receiving a request to create a new timesheet for a restricted airspace. The resulting timetable of the restricted airspace is advertised through the ASD service.
Category	<Functional>

[REQ Trace]

Relationship	Linked Element Type	Identifier
<ALLOCATED_TO>	<SESAR Solution>	PJ.10-W2-93A PJ.10-W2-93B
<ALLOCATED_TO>	<Enabler>	SVC-022_Provision and Consumption of Operational Configuration Management Service ER APP ATC 184_ATM Data Service Provider for ATC services in a Virtual Centre context ER APP ATC 186_Virtual Centre ATSU
<ALLOCATED_TO>	<Service>	OperationalConfigurationManagement

[REQ]

Identifier	REQ-16-03-TS-OPM.0021
Title	Deletion of a timesheet for a restricted airspace
Requirement	Upon reception of a request to delete a timesheet for a restricted airspace (ARES or CDR), an OPCONFM service provider shall remove this timesheet from the timetable of the restricted airspace.
Status	<in progress>

Rationale	<p>This requirement specifies the actions of the OPCONFM service provider when receiving a request to delete a timesheet for a restricted airspace.</p> <p>The resulting timetable of the restricted airspace is advertised through the ASD service.</p>
Category	<Functional>

[REQ Trace]

Relationship	Linked Element Type	Identifier
<ALLOCATED_TO>	<SESAR Solution>	PJ.10-W2-93A PJ.10-W2-93B
<ALLOCATED_TO>	<Enabler>	SVC-022_Provision and Consumption of Operational Configuration Management Service ER APP ATC 184_ATM Data Service Provider for ATC services in a Virtual Centre context ER APP ATC 186_Virtual Centre ATSU
<ALLOCATED_TO>	<Service>	OperationalConfigurationManagement

[REQ]

Identifier	REQ-16-03-TS-OPM.0022
Title	Update of a timesheet for a restricted airspace
Requirement	Upon reception of a request to update a timesheet for a restricted airspace (ARES or CDR), an OPCONFM service provider shall replace this timesheet with the modified one in the timetable of the restricted airspace.
Status	<in progress>
Rationale	<p>This requirement specifies the actions of the OPCONFM service provider when receiving a request to update a timesheet for a restricted airspace.</p> <p>The resulting timetable of the restricted airspace is advertised through the ASD service.</p>
Category	<Functional>

[REQ Trace]

Relationship	Linked Element Type	Identifier

<ALLOCATED_TO>	<SESAR Solution>	PJ.10-W2-93A PJ.10-W2-93B
<ALLOCATED_TO>	<Enabler>	SVC-022_Provision and Consumption of Operational Configuration Management Service ER APP ATC 184_ATM Data Service Provider for ATC services in a Virtual Centre context ER APP ATC 186_Virtual Centre ATSU
<ALLOCATED_TO>	<Service>	OperationalConfigurationManagement

4.2.1.2.5.2.7 Requirements for managing the status of restricted airspaces

An example scenario where these requirements are applicable is illustrated in section 4.2.1.2.5.1.4.

[REQ]

Identifier	REQ-16-03-TS-OPM.0023
Title	Addition of a comment to an Airspace Reservation (ARES)
Requirement	<p>Upon reception of a request to add a comment to an Airspace Reservation (ARES), an OPCONFM service provider shall:</p> <ul style="list-style-type: none"> • check that no comment already exists for this Airspace Reservation and add the comment to it, • otherwise reject the request.
Status	<in progress>
Rationale	<p>This requirement specifies the actions of the OPCONFM service provider when receiving a request to add a comment to an Airspace Reservation.</p> <p>The updated Airspace Reservation is advertised through the ASD service.</p>
Category	<Functional>

[REQ Trace]

Relationship	Linked Element Type	Identifier
<ALLOCATED_TO>	<SESAR Solution>	PJ.10-W2-93A PJ.10-W2-93B
<ALLOCATED_TO>	<Enabler>	SVC-022_Provision and Consumption of Operational Configuration Management Service

		ER APP ATC 184_ATM Data Service Provider for ATC services in a Virtual Centre context ER APP ATC 186_Virtual Centre ATSU
<ALLOCATED_TO>	<Service>	OperationalConfigurationManagement

[REQ]

Identifier	REQ-16-03-TS-OPM.0024
Title	Modification of the comment of an Airspace Reservation (ARES)
Requirement	<p>Upon reception of a request to modify the comment of an Airspace Reservation (ARES), an OPCONFM service provider shall:</p> <ul style="list-style-type: none"> • check that a comment already exists for this Airspace Reservation and update it, • otherwise reject the request.
Status	<in progress>
Rationale	<p>This requirement specifies the actions of the OPCONFM service provider when receiving a request to modify the comment to an Airspace Reservation.</p> <p>The updated Airspace Reservation is advertised through the ASD service.</p>
Category	<Functional>

[REQ Trace]

Relationship	Linked Element Type	Identifier
<ALLOCATED_TO>	<SESAR Solution>	PJ.10-W2-93A PJ.10-W2-93B
<ALLOCATED_TO>	<Enabler>	SVC-022_Provision and Consumption of Operational Configuration Management Service ER APP ATC 184_ATM Data Service Provider for ATC services in a Virtual Centre context ER APP ATC 186_Virtual Centre ATSU
<ALLOCATED_TO>	<Service>	OperationalConfigurationManagement

[REQ]

Identifier	REQ-16-03-TS-OPM.0025
Title	Modification of the status of an Airspace Reservation (ARES)
Requirement	Upon reception of a request to activate or deactivate an Airspace Reservation (ARES), an OPCONFM service provider shall update the status of the Airspace Reservation accordingly.
Status	<in progress>
Rationale	This requirement specifies the actions of the OPCONFM service provider when receiving a request to activate or deactivate an Airspace Reservation. The updated Airspace Reservation status is advertised through the ASD service.
Category	<Functional>

[REQ Trace]

Relationship	Linked Element Type	Identifier
<ALLOCATED_TO>	<SESAR Solution>	PJ.10-W2-93A PJ.10-W2-93B
<ALLOCATED_TO>	<Enabler>	SVC-022_Provision and Consumption of Operational Configuration Management Service ER APP ATC 184_ATM Data Service Provider for ATC services in a Virtual Centre context ER APP ATC 186_Virtual Centre ATSU
<ALLOCATED_TO>	<Service>	OperationalConfigurationManagement

[REQ]

Identifier	REQ-16-03-TS-OPM.0026
Title	Modification of the status of a Conditional Route (CDR)
Requirement	Upon reception of a request to open or close a Conditional Route (CDR), an OPCONFM service provider shall update the status of the Conditional Route accordingly.
Status	<in progress>
Rationale	This requirement specifies the actions of the OPCONFM service provider when receiving a request to open or close a Conditional Route. The updated Conditional Route status is advertised through the ASD service.
Category	<Functional>

[REQ Trace]

Relationship	Linked Element Type	Identifier
<ALLOCATED_TO>	<SESAR Solution>	PJ.10-W2-93A PJ.10-W2-93B
<ALLOCATED_TO>	<Enabler>	SVC-022_Provision and Consumption of Operational Configuration Management Service ER APP ATC 184_ATM Data Service Provider for ATC services in a Virtual Centre context ER APP ATC 186_Virtual Centre ATSU
<ALLOCATED_TO>	<Service>	OperationalConfigurationManagement

[REQ]

Identifier	REQ-16-03-TS-OPM.0027
Title	Lock of the status of a restricted airspace
Requirement	After updating the status of a restricted airspace (ARES or CDR) on request, an OPCONFM service provider shall keep this status unchanged until a next request to unlock this restricted airspace or to update its status again.
Status	<in progress>
Rationale	The manual change of status supersedes the timetable of the restricted airspace.
Category	<Functional>

[REQ Trace]

Relationship	Linked Element Type	Identifier
<ALLOCATED_TO>	<SESAR Solution>	PJ.10-W2-93A PJ.10-W2-93B
<ALLOCATED_TO>	<Enabler>	SVC-022_Provision and Consumption of Operational Configuration Management Service ER APP ATC 184_ATM Data Service Provider for ATC services in a Virtual Centre context ER APP ATC 186_Virtual Centre ATSU
<ALLOCATED_TO>	<Service>	OperationalConfigurationManagement

[REQ]

Identifier	REQ-16-03-TS-OPM.0028
Title	Unlock of the status of a restricted airspace
Requirement	Upon reception of a request to unlock a restricted airspace (ARES or CDR), an OPCONFM service provider shall revert to setting the status of the restricted airspace according to its timetable and the current time.
Status	<in progress>
Rationale	When unlocked, a restricted airspace goes by to its automatic functioning, i.e. according to the current time and the applicable timesheet. The updated status of the restricted airspace is advertised through the ASD service.
Category	<Functional>

[REQ Trace]

Relationship	Linked Element Type	Identifier
<ALLOCATED_TO>	<SESAR Solution>	PJ.10-W2-93A PJ.10-W2-93B
<ALLOCATED_TO>	<Enabler>	SVC-022_Provision and Consumption of Operational Configuration Management Service ER APP ATC 184_ATM Data Service Provider for ATC services in a Virtual Centre context ER APP ATC 186_Virtual Centre ATSU
<ALLOCATED_TO>	<Service>	OperationalConfigurationManagement

4.2.1.2.5.2.8 *Requirements for managing Aerodrome Configurations*

An example scenario where these requirements are applicable is illustrated in section 4.2.1.2.5.1.5, which also contains some definitions helping the reading of these requirements.

[REQ]

Identifier	REQ-16-03-TS-OPM.0030
Title	Activation of a configuration for an Aerodrome Group

Requirement	Upon reception of a request to activate a given Aerodrome Group Configuration, the OPCONFM service provider shall replace the Current Aerodrome Group Configuration with this requested one.
Status	<in progress>
Rationale	<p>This requirement specifies the actions of the OPCONFM service provider when receiving a request to activate an off-line predefined Aerodrome Group Configuration. This request can in particular ask to restore the Default configuration or to activate the one previously defined as the Next one.</p> <p>The resulting On-Line Aerodrome Group Configuration Information is advertised through the OPCONFD service.</p>
Category	<Functional>

[REQ Trace]

Relationship	Linked Element Type	Identifier
<ALLOCATED_TO>	<SESAR Solution>	PJ.10-W2-93A PJ.10-W2-93B
<ALLOCATED_TO>	<Enabler>	SVC-022_Provision and Consumption of Operational Configuration Management Service ER APP ATC 184_ATM Data Service Provider for ATC services in a Virtual Centre context ER APP ATC 186_Virtual Centre ATSU
<ALLOCATED_TO>	<Service>	OperationalConfigurationManagement

[REQ]

Identifier	REQ-16-03-TS-OPM.0031
Title	Modification of the current configuration for an Aerodrome
Requirement	Upon reception of a request to modify the current parameters of an Aerodrome, the OPCONFM service provider shall update, as requested, the Current Aerodrome Group Configuration to which this aerodrome belongs.
Status	<in progress>

Rationale	<p>This requirement specifies the actions of the OPCONFM service provider when receiving a request to modify the current parameters of an Aerodrome.</p> <p>The resulting On-Line Aerodrome Group Configuration Information is advertised through the OPCONFD service.</p>
Category	<Functional>

[REQ Trace]

Relationship	Linked Element Type	Identifier
<ALLOCATED_TO>	<SESAR Solution>	PJ.10-W2-93A PJ.10-W2-93B
<ALLOCATED_TO>	<Enabler>	SVC-022_Provision and Consumption of Operational Configuration Management Service ER APP ATC 184_ATM Data Service Provider for ATC services in a Virtual Centre context ER APP ATC 186_Virtual Centre ATSU
<ALLOCATED_TO>	<Service>	OperationalConfigurationManagement

[REQ]

Identifier	REQ-16-03-TS-OPM.0032
Title	Modification of the current runway configurations for an Aerodrome
Requirement	Upon reception of a request to modify the current configurations of the runways for the aerodrome of an Aerodrome Group, the OPCONFM service provider shall update this Current Aerodrome Group Configuration as requested.
Status	<in progress>
Rationale	<p>This requirement specifies the actions of the OPCONFM service provider when receiving a request to modify the parameters of the current configuration of the runways for the aerodrome of an Aerodrome Group.</p> <p>The resulting On-Line Aerodrome Group Configuration Information is advertised through the OPCONFD service.</p>
Category	<Functional>

[REQ Trace]

Relationship	Linked Element Type	Identifier
<ALLOCATED_TO>	<SESAR Solution>	PJ.10-W2-93A PJ.10-W2-93B
<ALLOCATED_TO>	<Enabler>	SVC-022_Provision and Consumption of Operational Configuration Management Service ER APP ATC 184_ATM Data Service Provider for ATC services in a Virtual Centre context ER APP ATC 186_Virtual Centre ATSU
<ALLOCATED_TO>	<Service>	OperationalConfigurationManagement

[REQ]

Identifier	REQ-16-03-TS-OPM.0033
Title	Planning the Next configuration for an Aerodrome Group
Requirement	Upon reception of a request to plan the Next Configuration for an Aerodrome Group, the OPCONFM service provider shall record this Configuration as planned to be the Next one in the On-Line Aerodrome Group Configuration Information.
Status	<in progress>
Rationale	This requirement specifies the actions of the OPCONFM service provider when receiving a request to identify the Next Configuration to be applied for an Aerodrome Group. The resulting On-Line Aerodrome Group Configuration Information is advertised through the OPCONFD service. Please note that no automatic processing is applied to the activation of the next configuration.
Category	<Functional>

[REQ Trace]

Relationship	Linked Element Type	Identifier
<ALLOCATED_TO>	<SESAR Solution>	PJ.10-W2-93A PJ.10-W2-93B
<ALLOCATED_TO>	<Enabler>	SVC-022_Provision and Consumption of Operational Configuration Management Service ER APP ATC 184_ATM Data Service Provider for ATC services in a Virtual Centre context

		ER APP ATC 186_Virtual Centre ATSU
<ALLOCATED_TO>	<Service>	OperationalConfigurationManagement

[REQ]

Identifier	REQ-16-03-TS-OPM.0034
Title	Deletion of the Next configuration for an Aerodrome Group
Requirement	Upon reception of a request to delete the Next Configuration for an Aerodrome Group, the OPCONFM service provider shall remove the Configuration previously identified as Next from the On-Line Aerodrome Group Configuration Information.
Status	<in progress>
Rationale	This requirement specifies the actions of the OPCONFM service provider when receiving a request to delete the Next Configuration for an Aerodrome Group. The resulting On-Line Aerodrome Group Configuration Information is advertised through the OPCONFM service.
Category	<Functional>

[REQ Trace]

Relationship	Linked Element Type	Identifier
<ALLOCATED_TO>	<SESAR Solution>	PJ.10-W2-93A PJ.10-W2-93B
<ALLOCATED_TO>	<Enabler>	SVC-022_Provision and Consumption of Operational Configuration Management Service ER APP ATC 184_ATM Data Service Provider for ATC services in a Virtual Centre context ER APP ATC 186_Virtual Centre ATSU
<ALLOCATED_TO>	<Service>	OperationalConfigurationManagement

4.2.1.2.5.2.9 Generic requirements for values for all kinds of OPCONFM requests

[REQ]

Identifier	REQ-16-03-TS-OPM.0029
Title	OPCONFM Request validity

Requirement	Upon reception of an OPCONFM request, the OPCONFM service provider shall return a Request report indicating the success or failure of the processing of the request.
Status	<validated>
Rationale	This requirement specifies the type of feedback the OPCONFM service provider has to provide after an OPCONFM request.
Category	<Functional>

[REQ Trace]

Relationship	Linked Element Type	Identifier
<ALLOCATED_TO>	<SESAR Solution>	PJ.10-W2-93A PJ.10-W2-93B
<ALLOCATED_TO>	<Enabler>	SVC-022_Provision and Consumption of Operational Configuration Management Service ER APP ATC 184_ATM Data Service Provider for ATC services in a Virtual Centre context ER APP ATC 186_Virtual Centre ATSU
<ALLOCATED_TO>	<Service>	OperationalConfigurationManagement

4.2.1.2.5.3 OPCONFD requirements

4.2.1.2.5.3.1 Requirements for publication of Sector Mappings

An example scenario where these requirements are applicable is illustrated in section 4.2.1.2.5.1.1.

[REQ]

Identifier	REQ-16-03-TS-OPD.0003
Title	Publication of Sector Mappings
Requirement	The OPCONFD service provider shall notify subscribers about any creation or update in the ATSU Sector Configuration in accordance with the subscription request parameters.
Status	<validated>
Rationale	The user may subscribe to the next and current mappings, or only to one of these.
Category	<Functional>

[REQ Trace]

Relationship	Linked Element Type	Identifier
<ALLOCATED_TO>	<SESAR Solution>	PJ.10-W2-93A PJ.10-W2-93B
<SATISFIES>	< ATMS Requirement>	REQ-PJ.10-W2.93-SPRINTEROP-IER.0003
<ALLOCATED_TO>	<Enabler>	SVC-021_Provision and Consumption of Operational Configuration Distribution Service ER APP ATC 184_ATM Data Service Provider for ATC services in a Virtual Centre context ER APP ATC 186_Virtual Centre ATSU
<ALLOCATED_TO>	<Service>	OperationalConfigurationDistribution

[REQ]

Identifier	REQ-10-W2.93-TS-OPD.0007
Title	Neighbouring ATSUs Configuration
Requirement	The OPCONFD service provider may include in the ATSU Sector Configuration distribution the sector configuration mappings of neighbouring ATSUs.
Status	<in progress>
Rationale	If ATSUs access to a common ADSP via their own services, it may be required that their configuration distribution service provides as well elements of the neighbouring ATSUs in order to facilitate delegation management.
Category	<Functional>

[REQ Trace]

Relationship	Linked Element Type	Identifier
<ALLOCATED_TO>	<SESAR Solution>	PJ.10-W2-93A PJ.10-W2-93B
<SATISFIES>	< ATMS Requirement>	REQ-PJ.10-W2.93-SPRINTEROP-IER.0003
<ALLOCATED_TO>	<Enabler>	SVC-049_Operational Configuration Distribution of Working Position Preview Mode, and Neighbouring ATSU Sector configuration for ATM Service Delegation
<ALLOCATED_TO>	<Functional block>	Operational Supervision Data Management ER/APP ATC (PJ.10-93)

[REQ]

Identifier	REQ-10-W2.93-TS-OPD.0008
Title	Preview Mode Distribution
Requirement	When the preview mode is set on sectors, the OPCONFD service provider shall include in the ATSU Sector Configuration distribution the preview responsibilities allocated to the corresponding working positions.
Status	<in progress>
Rationale	Preview Mode is managed with Preview Responsibility of a working position.
Category	<Functional>

[REQ Trace]

Relationship	Linked Element Type	Identifier
<ALLOCATED_TO>	<SESAR Solution>	PJ.10-W2-93A PJ.10-W2-93B
<ALLOCATED_TO>	<Enabler>	SVC-049_Operational Configuration Distribution of Working Position Preview Mode, and Neighbouring ATSU Sector configuration for ATM Service Delegation
<ALLOCATED_TO>	<Functional block>	Operational Supervision Data Management ER/APP ATC (PJ.10-93)

4.2.1.2.5.3.2 Requirements for getting the Sector Mappings of an ATSU sector Configuration

An example scenario where these requirements are applicable is illustrated in section 4.2.1.2.5.1.2.

[REQ]

Identifier	REQ-16-03-TS-OPD.0004
Title	Request current and next Sector Mappings
Requirement	Upon reception of a request to get all Sector Mappings of an ATSU Sector Configuration, the OPCONFD service provider shall provide the consumer with the current Sector Mapping and the next Sector Mapping (if one exists) for this ATSU Sector Configuration.
Status	<validated>
Rationale	This capability can for instance be used when starting a position, to get the active mappings.
Category	<Functional>

[REQ Trace]

Relationship	Linked Element Type	Identifier
<ALLOCATED_TO>	<SESAR Solution>	PJ.10-W2-93A PJ.10-W2-93B
<ALLOCATED_TO>	<Enabler>	SVC-021_Provision and Consumption of Operational Configuration Distribution Service ER APP ATC 184_ATM Data Service Provider for ATC services in a Virtual Centre context ER APP ATC 186_Virtual Centre ATSU
<ALLOCATED_TO>	<Service>	OperationalConfigurationDistribution

4.2.1.2.5.3.3 Requirements for publication of radio frequency allocation plan

An example scenario where these requirements are applicable is illustrated in section 4.2.1.2.5.1.3.

[REQ]

Identifier	REQ-16-03-TS-OPD.0005
Title	Publication of radio frequency allocation plan
Requirement	The OPCONFD service provider shall notify subscribers about any change in the current frequency allocation plan in accordance with the subscription request parameters.
Status	<in progress>
Rationale	This requirement specifies the actions of the OPCONFD service provider when a change occurs in the current frequency allocation plan.
Category	<Functional>

[REQ Trace]

Relationship	Linked Element Type	Identifier
<ALLOCATED_TO>	<SESAR Solution>	PJ.10-W2-93A PJ.10-W2-93B
<SATISFIES>	< ATMS Requirement>	REQ-PJ.10-W2-93-SPRINTEROP-IER.0001
<ALLOCATED_TO>	<Enabler>	SVC-021_Provision and Consumption of Operational Configuration Distribution Service

		ER APP ATC 184_ATM Data Service Provider for ATC services in a Virtual Centre context ER APP ATC 186_Virtual Centre ATSU
<ALLOCATED_TO>	<Service>	OperationalConfigurationDistribution

4.2.1.2.5.3.4 Requirements for requesting a radio frequency allocation plan

An example scenario where these requirements are applicable is illustrated in section 4.2.1.2.5.1.3.

[REQ]

Identifier	REQ-16-03-TS-OPD.0006
Title	Request a radio frequency allocation plan
Requirement	Upon reception of a request to get a radio frequency allocation plan, the OPCONFD service provider shall provide the consumer with this radio frequency allocation plan, including free frequencies.
Status	<in progress>
Rationale	The consumer may request the radio frequency plan of a Sector Configuration of his ATS, or radio frequency plans of other ATSU known by the OFCONFD Service Provider. The names of these radio frequency plans are pre-defined off-line and known by the consumer.
Category	<Functional>

[REQ Trace]

Relationship	Linked Element Type	Identifier
<ALLOCATED_TO>	<SESAR Solution>	PJ.10-W2-93A PJ.10-W2-93B
<ALLOCATED_TO>	<Enabler>	SVC-021_Provision and Consumption of Operational Configuration Distribution Service ER APP ATC 184_ATM Data Service Provider for ATC services in a Virtual Centre context ER APP ATC 186_Virtual Centre ATSU
<ALLOCATED_TO>	<Service>	OperationalConfigurationDistribution

4.2.1.2.5.3.5 Requirements for publication of Aerodrome Configurations

An example scenario where these requirements are applicable is illustrated in section 4.2.1.2.5.1.5.

[REQ]

Identifier	REQ-16-03-TS-OPD.0003
Title	Publication of Aerodrome Group Configurations
Requirement	The OPCONFD service provider shall notify subscribers about any change in the On-line Aerodrome Group Configuration Information in accordance with the subscription request parameters.
Status	<in progress>
Rationale	This requirement specifies the actions of the OPCONFD service provider when a change occurs in the any On-line Aerodrome Group Configuration Information.
Category	<Functional>

[REQ Trace]

Relationship	Linked Element Type	Identifier
<ALLOCATED_TO>	<SESAR Solution>	PJ.10-W2-93A PJ.10-W2-93B
<ALLOCATED_TO>	<Enabler>	SVC-021_Provision and Consumption of Operational Configuration Distribution Service ER APP ATC 184_ATM Data Service Provider for ATC services in a Virtual Centre context ER APP ATC 186_Virtual Centre ATSU
<ALLOCATED_TO>	<Service>	OperationalConfigurationDistribution

4.2.1.2.5.3.6 Requirements for getting the Aerodrome Configurations

[REQ]

Identifier	REQ-16-03-TS-OPD.0004
Title	Request Aerodrome Group Configurations
Requirement	Upon reception of a request to get the configuration of the Aerodrome Groups (or of a specific one), the OPCONFD service provider shall provide the consumer with the On-line Aerodrome Group Configuration Information for all the Aerodrome Groups (or for the specific one).
Status	<in progress>
Rationale	This capability can for instance be used when starting a position, to get the active Aerodrome Group Configurations.
Category	<Functional>

[REQ Trace]

Relationship	Linked Element Type	Identifier
<ALLOCATED_TO>	<SESAR Solution>	PJ.10-W2-93A PJ.10-W2-93B
<ALLOCATED_TO>	<Enabler>	SVC-021_Provision and Consumption of Operational Configuration Distribution Service ER APP ATC 184_ATM Data Service Provider for ATC services in a Virtual Centre context ER APP ATC 186_Virtual Centre ATSU
<ALLOCATED_TO>	<Service>	OperationalConfigurationDistribution

4.2.1.3 Monitoring Aids Service (MONAD) [PJ.32-W3-02]

4.2.1.3.1 Service Overview

MONA tools use surveillance information, controller clearances and instructions, planned trajectory information and other data to compare the actual behaviour of an aircraft against its expected behaviour.

In particular, Monitoring Aids are a suite of tools that can monitor:

- Conformance to ATC clearances;
- Conformance to the planned (expected) trajectory in the vertical, horizontal and longitudinal (i.e. time) planes;
- Infringements of restricted airspace (e.g. SUA, Holds, controlled airspace, RVSM and 8.33 KHz airspace etc.);
- Conformance to PRNAV routes;
- Check pilot selected intent against ATC instructions, e.g. selected flight level versus cleared flight level.

Monitoring Aids Alerts may be distributed in two ways:

1. they are refreshed every update to the surveillance and downlinked data so there is no need to initialise upon subscription.
2. they are 'latched' on with no further updates until the hazard/deviation has disappeared and the alert is cancelled by an 'End of Alert' message.

Different ATSUs will have different monitoring requirements to suit their particular operational environment so it is probable that a consumer of MONA would wish to select the alerts that are of interest.

MONA provides no operations to the users.

4.2.1.3.2 Service Assumptions

Assumptions for the environment and other ATM operations are stated in Table below.

Identifier	Assumption	Comment
MONA-ASSUMPTION-001	MONA is a distribution service only. There are no user operations supported.	MONA publishes alerts as required. If alerts need to be acknowledged and suppressed, then that is done locally at the CWP so that one controller cannot suppress alerts to all other controllers for a particular flight.
MONA-ASSUMPTION-002	MONA is able to receive flight data, specifically trajectory information, for all flights of interest.	MONA needs to evaluate how close a track is to the predicted trajectory and publish alerts when it deviates more than a threshold.
MONA-ASSUMPTION-003	MONA is able to receive surveillance information including position, rate of climb/descent, heading and speed.	MONA needs to be able to compare an aircraft current position, speed, heading and ROCD against controller clearances.
MONA-ASSUMPTION-004	MONA is able to receive correlation information for flights	MONA needs to be able to identify which flight a track corresponds to so that it can re the track data to the flight data.
MONA-ASSUMPTION-005	MONA is able to receive downlinked aircraft information including selected level, heading and speed.	MONA needs to be able to compare the intention of the cockpit crew against controller clearances and instructions
MONA-ASSUMPTION-006	Monitoring Aids Warnings and Alerts are refreshed every update to the surveillance and downlinked data so there is no need to initialise upon subscription.	By updating the status of alerts and warnings every time there is an update to the surveillance information there is no need to initialise a CWP on subscription to the service.

Table 15: [MONA] Environmental conditions

4.2.1.3.3 Service Dependencies

MONA is a distribution service and is not dependant on a management service. Dependencies on other data providers are described in the Service Assumptions section.

4.2.1.3.4 Interface Interoperability requirements

The operations and message payloads that the MONA services providers and consumers need to be compliant with are identified in this section.

[REQ]

Identifier	REQ-16-03-TS-MONA.0001
Title	Support of MONA payload data types
Requirement	The provider and the consumer of the Monitoring Aids service shall comply with the message definition specified in Appendix A Part 1, SDD section 7, "Payload Data Types".
Status	<validated>
Rationale	This requirement ensures that service provider and service consumers are interoperable at the message level.
Category	

[REQ Trace]

Relationship	Linked Element Type	Identifier
<ALLOCATED_TO>	<SESAR Solution>	PJ.10-W2-93A PJ.10-W2-93B
<ALLOCATED_TO>	<Enabler>	ER APP ATC 184_ATM Data Service Provider for ATC services in a Virtual Centre context ER APP ATC 186_Virtual Centre ATSU SVC-020_Provision and Consumption of Monitoring Aids Distribution Service
<ALLOCATED_TO>	<Service>	MonitoringAidsDistribution (PJ.32-WP3)

4.2.1.3.5 Dynamic Behaviour requirements

4.2.1.3.5.1 Reference Behaviour Scenarios

MONA does not provide operations to the user so there are no dynamic behaviours apart from subscription to and un-subscription from the service and the publication of alerts and warnings.

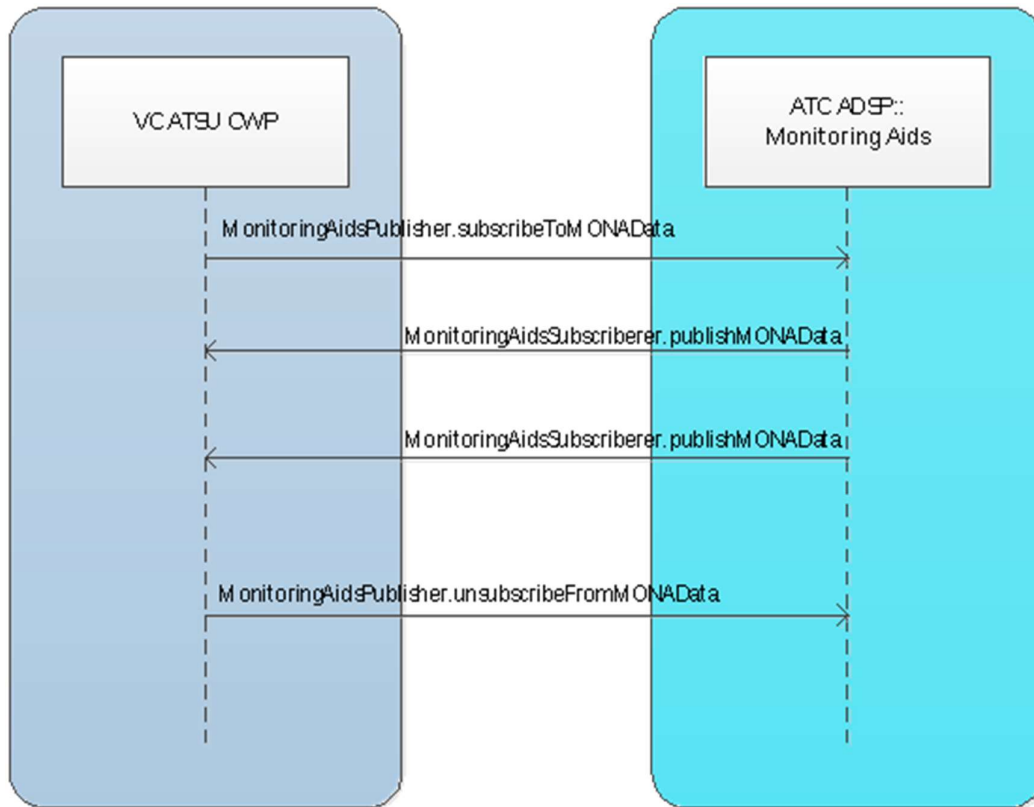

Figure 18: [MONA] Reference Behaviour for Subscription, Distribution and Un-subscription

- A CWP requests the subscription to the Monitoring Aids Distribution service.
- When the subscription is processed, the monitoring aids alerts and warnings are distributed as they are generated to the subscriber.
- When the CWP unsubscribes from the Monitoring Aids Distribution service, the distribution of monitoring aids alerts and warnings to that CWP terminates.

4.2.1.3.5.2 MONA requirements

4.2.1.3.5.2.1 Requirements for Trajectory Conformance

[REQ]

Identifier	REQ-16-03-TS-MONA.0002
Title	Monitor Track Position Relative to Planned Trajectory
Requirement	<p>If a MONA service provider receives a track update for a correlated flight, it shall:</p> <ul style="list-style-type: none"> • compare the track position with the planned trajectory of the flight; • determine any deviations in the longitudinal, vertical and lateral axes; and • alert users if the deviation exceeds a specified threshold.

Status	<validated>
Rationale	It is useful for a controller to know when a flight is deviating from its planned trajectory.
Category	<Functional>

[REQ Trace]

Relationship	Linked Element Type	Identifier
<ALLOCATED_TO>	<SESAR Solution>	PJ.10-W2-93A PJ.10-W2-93B
<ALLOCATED_TO>	<Enabler>	ER APP ATC 184_ATM Data Service Provider for ATC services in a Virtual Centre context ER APP ATC 186_Virtual Centre ATSU SVC-020_Provision and Consumption of Monitoring Aids Distribution Service
<ALLOCATED_TO>	<Service>	MonitoringAidsDistribution (PJ.32-WP3)

[REQ]

Identifier	REQ-16-03-TS-MONA.0003
Title	Monitor Track Position Relative to P-RNAV route
Requirement	A MONA service provider shall monitor flights for conformance to assigned P-RNAV routes and alert users if they deviate beyond a specified threshold.
Status	<in progress>
Rationale	It is useful for a controller to know when a flight is deviating from its assigned route. P-RNAV requirements are generally much stricter than normal trajectory conformance limits.
Category	<Functional>

[REQ Trace]

Relationship	Linked Element Type	Identifier
<ALLOCATED_TO>	<SESAR Solution>	PJ.10-W2-93A PJ.10-W2-93B
<ALLOCATED_TO>	<Enabler>	ER APP ATC 184_ATM Data Service Provider for ATC services in a Virtual Centre context ER APP ATC 186_Virtual Centre ATSU

		SVC-020_Provision and Consumption of Monitoring Aids Distribution Service
<ALLOCATED_TO>	<Service>	MonitoringAidsDistribution (PJ.32-WP3)

4.2.1.3.5.2.2 Requirements for Clearance Conformance

[REQ]

Identifier	REQ-16-03-TS-MONA.0004
Title	Monitor Rate of Climb or Descent (ROCD)
Requirement	If a MONA service provider determines that a flight is not complying with an instruction to climb or descend at a particular rate (within a specified tolerance) it shall alert users to the non-compliance.
Status	<validated>
Rationale	If a flight is not complying with an instruction it may lead to a loss of separation. A controller needs to be alerted if such a situation arises.
Category	<Functional>

[REQ Trace]

Relationship	Linked Element Type	Identifier
<ALLOCATED_TO>	<SESAR Solution>	PJ.10-W2-93A PJ.10-W2-93B
<ALLOCATED_TO>	<Enabler>	ER APP ATC 184_ATM Data Service Provider for ATC services in a Virtual Centre context ER APP ATC 186_Virtual Centre ATSU SVC-020_Provision and Consumption of Monitoring Aids Distribution Service
<ALLOCATED_TO>	<Service>	MonitoringAidsDistribution (PJ.32-WP3)

[REQ]

Identifier	REQ-16-03-TS-MONA.0005
Title	Monitor Level Busts
Requirement	If a MONA service provider determines that a flight is likely to exceed or has exceeded its level clearance, either in a climb or descent, it shall alert users to the probability or reality of a level bust.

Status	<validated>
Rationale	If a flight is climbing or descending too fast such that it is unlikely to level off in time to meet its cleared flight level or altitude or it has exceeded the clearance it may lead to a loss of separation. A controller needs to be alerted if such a situation arises so as to take mitigating action.
Category	<Functional>

[REQ Trace]

Relationship	Linked Element Type	Identifier
<ALLOCATED_TO>	<SESAR Solution>	PJ.10-W2-93A PJ.10-W2-93B
<ALLOCATED_TO>	<Enabler>	ER APP ATC 184_ATM Data Service Provider for ATC services in a Virtual Centre context ER APP ATC 186_Virtual Centre ATSU SVC-020_Provision and Consumption of Monitoring Aids Distribution Service
<ALLOCATED_TO>	<Service>	MonitoringAidsDistribution (PJ.32-WP3)

[REQ]

Identifier	REQ-16-03-TS-MONA.0006
Title	Monitor Premature Level Off
Requirement	If a MONA service provider determines that an aircraft is climbing/descending at such a slow Rate of Climb/Descent that there is the potential of the aircraft levelling off before it has reached its level, it shall alert users to the likely non-compliance.
Status	<validated>
Rationale	If a flight is levels off before it reaches its cleared flight level or altitude it may lead to a loss of separation. A controller needs to be alerted if such a situation arises so as to take mitigating action.
Category	<Functional>

[REQ Trace]

Relationship	Linked Element Type	Identifier
<ALLOCATED_TO>	<SESAR Solution>	PJ.10-W2-93A

		PJ.10-W2-93B
<ALLOCATED_TO>	<Enabler>	ER APP ATC 184_ATM Data Service Provider for ATC services in a Virtual Centre context ER APP ATC 186_Virtual Centre ATSU SVC-020_Provision and Consumption of Monitoring Aids Distribution Service
<ALLOCATED_TO>	<Service>	MonitoringAidsDistribution (PJ.32-WP3)

[REQ]

Identifier	REQ-16-03-TS-MONA.0007
Title	Monitor Speed Conformance
Requirement	If a MONA service provider determines that a flight is not complying with a speed instruction (within a specified tolerance), it shall alert users to the non-compliance.
Status	<in progress>
Rationale	If a flight is not conforming to a speed instruction it may lead to a loss of separation. A controller needs to be alerted if such a situation arises so as to take mitigating action.
Category	<Functional>

[REQ Trace]

Relationship	Linked Element Type	Identifier
<ALLOCATED_TO>	<SESAR Solution>	PJ.10-W2-93A PJ.10-W2-93B
<ALLOCATED_TO>	<Enabler>	ER APP ATC 186_Virtual Centre ATSU ER APP ATC 184_ATM Data Service Provider for ATC services in a Virtual Centre context SVC-020_Provision and Consumption of Monitoring Aids Distribution Service
<ALLOCATED_TO>	<Service>	MonitoringAidsDistribution (PJ.32-WP3)

[REQ]

Identifier	REQ-16-03-TS-MONA.0008
Title	Monitor Heading Conformance

Requirement	If a MONA service provider determines that a flight is not complying with a heading instruction (within a specified tolerance), it shall alert users to the non-compliance.
Status	<validated>
Rationale	If a flight is not conforming to a heading instruction it may lead to a loss of separation. A controller needs to be alerted if such a situation arises so as to take mitigating action.
Category	<Functional>

[REQ Trace]

Relationship	Linked Element Type	Identifier
<ALLOCATED_TO>	<SESAR Solution>	PJ.10-W2-93A PJ.10-W2-93B
<ALLOCATED_TO>	<Enabler>	ER APP ATC 184_ATM Data Service Provider for ATC services in a Virtual Centre context ER APP ATC 186_Virtual Centre ATSU SVC-020_Provision and Consumption of Monitoring Aids Distribution Service
<ALLOCATED_TO>	<Service>	MonitoringAidsDistribution (PJ.32-WP3)

[REQ]

Identifier	REQ-16-03-TS-MONA.0009
Title	Monitor Cleared Flight Level Conformance
Requirement	If a MONA service provider determines that a flight is not complying with a level clearance (CFL), it shall alert users to the non-compliance.
Status	<validated>
Rationale	If a flight is not conforming to a CFL instruction it may lead to a loss of separation. A controller needs to be alerted if such a situation arises so as to take mitigating action.
Category	<Functional>

[REQ Trace]

Relationship	Linked Element Type	Identifier
<ALLOCATED_TO>	<SESAR Solution>	PJ.10-W2-93A PJ.10-W2-93B

<ALLOCATED_TO>	<Enabler>	ER APP ATC 184_ATM Data Service Provider for ATC services in a Virtual Centre context ER APP ATC 186_Virtual Centre ATSU SVC-020_Provision and Consumption of Monitoring Aids Distribution Service
<ALLOCATED_TO>	<Service>	MonitoringAidsDistribution (PJ.32-WP3)

4.2.1.3.5.2.3 Requirements for Pilot Intent Monitoring

[REQ]

Identifier	REQ-16-03-TS-MONA.0010
Title	Monitor Selected Heading of Mode-S Capable Flights
Requirement	If a MONA service provider determines that the selected heading of a Mode-S capable flight does not match the heading clearance, it shall alert users to the non-compliance.
Status	<in progress>
Rationale	If a flight is not complying with a clearance or instruction it may lead to a loss of separation. A controller needs to be alerted if such a situation arises.
Category	<Functional>

[REQ Trace]

Relationship	Linked Element Type	Identifier
<ALLOCATED_TO>	<SESAR Solution>	PJ.10-W2-93A PJ.10-W2-93B
<ALLOCATED_TO>	<Enabler>	ER APP ATC 184_ATM Data Service Provider for ATC services in a Virtual Centre context ER APP ATC 186_Virtual Centre ATSU SVC-020_Provision and Consumption of Monitoring Aids Distribution Service
<ALLOCATED_TO>	<Service>	MonitoringAidsDistribution (PJ.32-WP3)

[REQ]

Identifier	REQ-16-03-TS-MONA.0011
Title	Monitor Selected IAS/Mach No of Mode-S Capable Flights

Requirement	If a MONA service provider determines that the selected IAS or Mach No of a Mode-S capable flight does not match the speed clearance, it shall alert users to the non-compliance.
Status	<in progress>
Rationale	If a flight is not complying with a clearance or instruction it may lead to a loss of separation. A controller needs to be alerted if such a situation arises.
Category	<Functional>

[REQ Trace]

Relationship	Linked Element Type	Identifier
<ALLOCATED_TO>	<SESAR Solution>	PJ.10-W2-93A PJ.10-W2-93B
<ALLOCATED_TO>	<Enabler>	ER APP ATC 184_ATM Data Service Provider for ATC services in a Virtual Centre context ER APP ATC 186_Virtual Centre ATSU SVC-020_Provision and Consumption of Monitoring Aids Distribution Service
<ALLOCATED_TO>	<Service>	MonitoringAidsDistribution (PJ.32-WP3)

[REQ]

Identifier	REQ-16-03-TS-MONA.0012
Title	Monitor Selected Flight Level or Altitude of Mode-S Capable Flights
Requirement	If a MONA service provider determines that the selected Flight Level or Altitude of a Mode-S capable flight does not match the Cleared Flight Level, it shall alert users to the non-compliance.
Status	<validated>
Rationale	If a flight is not complying with a clearance or instruction it may lead to a loss of separation. A controller needs to be alerted if such a situation arises.
Category	<Functional>

[REQ Trace]

Relationship	Linked Element Type	Identifier
<ALLOCATED_TO>	<SESAR Solution>	PJ.10-W2-93A

		PJ.10-W2-93B
<ALLOCATED_TO>	<Enabler>	ER APP ATC 184_ATM Data Service Provider for ATC services in a Virtual Centre context ER APP ATC 186_Virtual Centre ATSU SVC-020_Provision and Consumption of Monitoring Aids Distribution Service
<ALLOCATED_TO>	<Service>	MonitoringAidsDistribution (PJ.32-WP3)

[REQ]

Identifier	REQ-16-03-TS-MONA.0013
Title	Monitor Selected Barometric Pressure Setting of Mode-S Capable Flights
Requirement	If a MONA service provider determines that the selected Barometric Pressure Setting of a Mode-S capable flight below the transition layer does not match the local pressure setting, it shall alert users to the non-compliance.
Status	<in progress>
Rationale	If a flight is not complying with a clearance or instruction it may lead to a loss of separation. A controller needs to be alerted if such a situation arises.
Category	<Functional>

[REQ Trace]

Relationship	Linked Element Type	Identifier
<ALLOCATED_TO>	<SESAR Solution>	PJ.10-W2-93A PJ.10-W2-93B
<ALLOCATED_TO>	<Enabler>	ER APP ATC 184_ATM Data Service Provider for ATC services in a Virtual Centre context ER APP ATC 186_Virtual Centre ATSU SVC-020_Provision and Consumption of Monitoring Aids Distribution Service
<ALLOCATED_TO>	<Service>	MonitoringAidsDistribution (PJ.32-WP3)

4.2.1.3.5.2.4 Requirements for Hold Monitoring

[REQ]

Identifier	REQ-16-03-TS-MONA.0014
Title	Flight leaves a hold before its Cleared Exit Time
Requirement	If a flight has a Cleared Exit Time from a hold and a MONA service provider determines that the flight has left the hold volume prematurely, it shall alert users to the deviation.
Status	<validated>
Rationale	If a flight is not complying with a clearance or instruction it may lead to a loss of separation. A controller needs to be alerted if such a situation arises.
Category	<Functional>

[REQ Trace]

Relationship	Linked Element Type	Identifier
<ALLOCATED_TO>	<SESAR Solution>	PJ.10-W2-93A PJ.10-W2-93B
<ALLOCATED_TO>	<Enabler>	ER APP ATC 184_ATM Data Service Provider for ATC services in a Virtual Centre context ER APP ATC 186_Virtual Centre ATSU SVC-020_Provision and Consumption of Monitoring Aids Distribution Service
<ALLOCATED_TO>	<Service>	MonitoringAidsDistribution (PJ.32-WP3)

[REQ]

Identifier	REQ-16-03-TS-MONA.0015
Title	Flight fails to leave a hold after it is cleared to leave the hold.
Requirement	If a flight has been cleared to leave a hold and a MONA service provider determines that the flight has not left the hold after a specified interval, it shall alert users to the deviation.
Status	<in progress>
Rationale	If a flight is not complying with a clearance or instruction it may lead to a loss of separation. A controller needs to be alerted if such a situation arises.
Category	<Functional>

[REQ Trace]

Relationship	Linked Element Type	Identifier
<ALLOCATED_TO>	<SESAR Solution>	PJ.10-W2-93A

		PJ.10-W2-93B
<ALLOCATED_TO>	<Enabler>	ER APP ATC 184_ATM Data Service Provider for ATC services in a Virtual Centre context ER APP ATC 186_Virtual Centre ATSU SVC-020_Provision and Consumption of Monitoring Aids Distribution Service
<ALLOCATED_TO>	<Service>	MonitoringAidsDistribution (PJ.32-WP3)

[REQ]

Identifier	REQ-16-03-TS-MONA.0016
Title	Slow Descent in the Hold
Requirement	If a flight has been cleared to descend from a level within a hold and a MONA service provider determines that the flight has not started to descend after a specified interval or it is descending at a very slow rate, it shall alert users.
Status	<in progress>
Rationale	If a flight is not complying with a clearance or instruction it may lead to a loss of separation. A controller needs to be alerted if such a situation arises.
Category	<Functional>

[REQ Trace]

Relationship	Linked Element Type	Identifier
<ALLOCATED_TO>	<SESAR Solution>	PJ.10-W2-93A PJ.10-W2-93B
<ALLOCATED_TO>	<Enabler>	ER APP ATC 184_ATM Data Service Provider for ATC services in a Virtual Centre context ER APP ATC 186_Virtual Centre ATSU SVC-020_Provision and Consumption of Monitoring Aids Distribution Service
<ALLOCATED_TO>	<Service>	MonitoringAidsDistribution (PJ.32-WP3)

4.2.1.3.5.2.5 Requirements for Monitoring Restricted Airspace

[REQ]

Identifier	REQ-16-03-TS-MONA.0017
------------	------------------------

Title	Flight infringes RVSM airspace
Requirement	If a flight that is not equipped to operate in RVSM airspace and is not exempt from the RVSM restriction and a MONA service provider determines that it is manoeuvring in such a way that it is likely to infringe RVSM airspace or has already done so it shall alert users to the infringement.
Status	<in progress>
Rationale	If a flight that is not RVSM equipped and is therefore unable to comply with the reduced separation criteria of that airspace but is likely to enter it then it may lead to a loss of separation. A controller needs to be alerted if such a situation arises.
Category	<Functional>

[REQ Trace]

Relationship	Linked Element Type	Identifier
<ALLOCATED_TO>	<SESAR Solution>	PJ.10-W2-93A PJ.10-W2-93B
<ALLOCATED_TO>	<Enabler>	ER APP ATC 186_Virtual Centre ATSU ER APP ATC 184_ATM Data Service Provider for ATC services in a Virtual Centre context SVC-020_Provision and Consumption of Monitoring Aids Distribution Service
<ALLOCATED_TO>	<Service>	MonitoringAidsDistribution (PJ.32-WP3)

[REQ]

Identifier	REQ-16-03-TS-MONA.0018
Title	Flight infringes 8.33KHz airspace
Requirement	If a flight that is not equipped to operate in 8.33KHz airspace and is not exempt from the 8.33KHz restriction and a MONA service provider determines that it is manoeuvring in such a way that it is likely to infringe 8.33KHz airspace or has already done so it shall alert users to the infringement.
Status	<in progress>
Rationale	If a flight that is not 8.33KHz equipped and is therefore unable to comply with the radio frequency requirements of that airspace but is likely to enter it then it will lead to a loss of voice communication and a potentially hazardous situation. A controller needs to be alerted if such a situation arises.
Category	<Functional>

[REQ Trace]

Relationship	Linked Element Type	Identifier
<ALLOCATED_TO>	<SESAR Solution>	PJ.10-W2-93A PJ.10-W2-93B
<ALLOCATED_TO>	<Enabler>	ER APP ATC 184_ATM Data Service Provider for ATC services in a Virtual Centre context ER APP ATC 186_Virtual Centre ATSU SVC-020_Provision and Consumption of Monitoring Aids Distribution Service
<ALLOCATED_TO>	<Service>	MonitoringAidsDistribution (PJ.32-WP3)

[REQ]

Identifier	REQ-16-03-TS-MONA.0019
Title	Flight infringes restricted airspace
Requirement	If a flight that is not cleared to operate in a restricted airspace volume (e.g. SUA, TRA, TSA) and a MONA service provider determines that it is maneuvering in such a way that it is likely to infringe that airspace or has already done so it shall alert users to the infringement.
Status	<in progress>
Rationale	If a flight is not cleared to enter a restricted volume of airspace, then it may lead to a loss of separation. A controller needs to be alerted if such a situation arises.
Category	<Functional>

[REQ Trace]

Relationship	Linked Element Type	Identifier
<ALLOCATED_TO>	<SESAR Solution>	PJ.10-W2-93A PJ.10-W2-93B
<ALLOCATED_TO>	<Enabler>	ER APP ATC 184_ATM Data Service Provider for ATC services in a Virtual Centre context ER APP ATC 186_Virtual Centre ATSU SVC-020_Provision and Consumption of Monitoring Aids Distribution Service
<ALLOCATED_TO>	<Service>	MonitoringAidsDistribution (PJ.32-WP3)

[REQ]

Identifier	REQ-16-03-TS-MONA.0020
Title	Flight infringes Hold volume
Requirement	If a flight that is not cleared to hold in a hold pattern or is not cleared to transit a hold volume and a MONA service provider determines that it is manoeuvring in such a way that it is likely to infringe that airspace or has already done so it shall alert users to the infringement.
Status	<in progress>
Rationale	If a flight enters a hold volume when it has not been cleared to do so it may lead to a loss of separation. A controller needs to be alerted if such a situation arises.
Category	<Functional>

[REQ Trace]

Relationship	Linked Element Type	Identifier
<ALLOCATED_TO>	<SESAR Solution>	PJ.10-W2-93A PJ.10-W2-93B
<ALLOCATED_TO>	<Enabler>	ER APP ATC 184_ATM Data Service Provider for ATC services in a Virtual Centre context ER APP ATC 186_Virtual Centre ATSU SVC-020_Provision and Consumption of Monitoring Aids Distribution Service
<ALLOCATED_TO>	<Service>	MonitoringAidsDistribution (PJ.32-WP3)

4.2.1.3.5.2.6 Requirements for Monitoring Intruders

[REQ]

Identifier	REQ-16-03-TS-MONA.0021
Title	Flight infringes controlled airspace
Requirement	If a flight that is not cleared to enter controlled airspace is manoeuvring in such a way that it is likely to infringe controlled airspace or has already done so it shall alert users to the infringement.
Status	<validated>
Rationale	If a flight that has not been granted access to controlled airspace but is likely to enter it then it may lead to a loss of separation. A controller needs to be alerted if such a situation arises.
Category	<Functional>

[REQ Trace]

Relationship	Linked Element Type	Identifier
<ALLOCATED_TO>	<SESAR Solution>	PJ.10-W2-93A PJ.10-W2-93B
<ALLOCATED_TO>	<Enabler>	ER APP ATC 184_ATM Data Service Provider for ATC services in a Virtual Centre context ER APP ATC 186_Virtual Centre ATSU SVC-020_Provision and Consumption of Monitoring Aids Distribution Service
<ALLOCATED_TO>	<Service>	MonitoringAidsDistribution (PJ.32-WP3)

4.2.1.3.5.2.7 Subscription and publication

[REQ]

Identifier	REQ-16-03-TS-MONA.0022
Title	Publication of Monitoring Aids Alerts
Requirement	A Monitoring Aids service provider shall alert subscribers when a flight has deviated from, or its intent as provided by Mode-S data, is different to its planned trajectory, controller clearances or instructions.
Status	<validated>
Rationale	MONA is responsible for alerting users to potentially hazardous deviations from its expected behaviour.
Category	<Functional>

[REQ Trace]

Relationship	Linked Element Type	Identifier
<ALLOCATED_TO>	<SESAR Solution>	PJ.10-W2-93A PJ.10-W2-93B
<ALLOCATED_TO>	<Enabler>	ER APP ATC 184_ATM Data Service Provider for ATC services in a Virtual Centre context ER APP ATC 186_Virtual Centre ATSU SVC-020_Provision and Consumption of Monitoring Aids Distribution Service

<ALLOCATED_TO>	<Service>	MonitoringAidsDistribution (PJ.32-WP3)
----------------	-----------	--

[REQ]

Identifier	REQ-16-03-TS-MONA.0023
Title	Publication of Monitoring Aids Alerts at each track update
Requirement	If the service level agreement (SLA) requires it, a Monitoring Aids service provider shall publish alerts at each track update cycle for as long as the conditions that caused the original alert are sustained or deteriorate.
Status	<in progress>
Rationale	Depending on the SLA, MONA is responsible for delivering alerts in a way that meets the agreed method. With this message delivery pattern, no Cancel Alert is required and no initialisation process is required after the service is subscribed to.
Category	<Functional>

[REQ Trace]

Relationship	Linked Element Type	Identifier
<ALLOCATED_TO>	<SESAR Solution>	PJ.10-W2-93A PJ.10-W2-93B
<ALLOCATED_TO>	<Enabler>	ER APP ATC 184_ATM Data Service Provider for ATC services in a Virtual Centre context ER APP ATC 186_Virtual Centre ATSU SVC-020_Provision and Consumption of Monitoring Aids Distribution Service
<ALLOCATED_TO>	<Service>	MonitoringAidsDistribution (PJ.32-WP3)

[REQ]

Identifier	REQ-16-03-TS-MONA.0024
Title	Publication of Monitoring Aids Alerts and Cancel Alerts
Requirement	If the service level agreement (SLA) requires it, a Monitoring Aids service provider shall publish alerts when they are first detected and subsequently a Cancel Alert when the conditions that caused the original alert no longer apply.
Status	<validated>

Rationale	<p>Depending on the SLA, MONA is responsible for delivering alerts in a way that meets the agreed method. With this message delivery pattern, a Cancel Alert is required and an initialisation process is necessary after subscription so as to receive all current alerts.</p> <p>Note: This message delivery pattern supports the acknowledgement of alerts more easily than alerts delivered each track update cycle.</p>
Category	<Functional>

[REQ Trace]

Relationship	Linked Element Type	Identifier
<ALLOCATED_TO>	<SESAR Solution>	PJ.10-W2-93A PJ.10-W2-93B
<ALLOCATED_TO>	<Enabler>	ER APP ATC 184_ATM Data Service Provider for ATC services in a Virtual Centre context ER APP ATC 186_Virtual Centre ATSU SVC-020_Provision and Consumption of Monitoring Aids Distribution Service
<ALLOCATED_TO>	<Service>	MonitoringAidsDistribution (PJ.32-WP3)

4.2.1.4 Technical Supervision Distribution Service (TECHSUPD) [PJ.32-W3-02]

4.2.1.4.1 Service Overview

The Technical Supervision Distribution service enables a technical supervisor on a Technical Supervisor HMI to monitor the services deployed at a virtual centre. The service is distributed to one or more ATM Data Service Providers (ADSP) and Air Traffic Service Units (ATSUs).

The purpose of the Technical Supervision Distribution service is to allow the user to:

- Monitor service availability: report if the service is fully available, operating with reduced resilience, stopped or failed.
- Monitor Appliance Status: report the status of virtual computer, storage and network components providing the service.
- Status Notification: provide real time notification of service status and appliance status to enable failure detection and analysis to assist in service restoration.

4.2.1.4.2 Service Assumptions

Assumptions for the environment and other ATM operations are stated in Table below.

Identifier	Assumption	Comment
TECSUPD-ASSUMPTION-001	The provider of the Technical Support service receives up to date information on the status of all the services within the ADSP required by subscribers to those services.	

Table 16: [TECHSUPD] Environmental conditions

4.2.1.4.3 Service Dependencies

From a consumer perspective, there are no dependencies between the TECSUPD service and any other service.

4.2.1.4.4 Interface Interoperability requirements

The operations and message payloads that the technical supervision distribution service providers and consumers need to be compliant with are identified in this section.

[REQ]

Identifier	REQ-16-03-TS-TECSUPD.0001
Title	Support of TECSUPD payload data types
Requirement	The provider and the consumers of the Technical Support Distribution service shall comply with the message definition specified in Appendix A Part 24, SDD section 7, "Payload Data Types".
Status	<validated>
Rationale	This requirement ensures that service producer and service consumers implementing the Technical Support Distribution service are interoperable at the message level.
Category	<Interface>

[REQ Trace]

Relationship	Linked Element Type	Identifier
<ALLOCATED_TO>	<SESAR Solution>	PJ.10-W2-93A PJ.10-W2-93B
<ALLOCATED_TO>	<Enabler>	ER APP ATC 184_ATM Data Service Provider for ATC services in a Virtual Centre context ER APP ATC 186_Virtual Centre ATSU SVC-029_Provision and Consumption of Technical Supervision Distribution Service
<ALLOCATED_TO>	<Service>	TechnicalSupervisionDistribution (PJ.32-WP3)

[REQ]

Identifier	REQ-16-03-TS-TECSUPD.0002
Title	Support of TECSUPD operations
Requirement	The provider of the Technical Support Distribution service shall provide the consumer the capability to invoke the operations specified in Appendix A, Part 24, SDD section 5, “Service Interface Specifications”.
Status	<validated>
Rationale	This requirement ensures that service producer and service consumers implementing the TECSUPD service are interoperable at the operation level.
Category	<Interface>

[REQ Trace]

Relationship	Linked Element Type	Identifier
<ALLOCATED_TO>	<SESAR Solution>	PJ.10-W2-93A PJ.10-W2-93B
<ALLOCATED_TO>	<Enabler>	ER APP ATC 186_Virtual Centre ATSU ER APP ATC 184_ATM Data Service Provider for ATC services in a Virtual Centre context SVC-029_Provision and Consumption of Technical Supervision Distribution Service
<ALLOCATED_TO>	<Service>	TechnicalSupervisionDistribution (PJ.32-WP3)

4.2.1.4.5 TECHSUPD requirements

[REQ]

Identifier	REQ-16-03-TS-TECSUPD.0003
Title	Technical Support Information Subscriber Initialisation
Requirement	When a consumer subscribes to the TECSUPD service, the TECSUPD service provider shall provide the consumer with all the technical support information for the services for which service status monitoring has been requested.
Status	<validated>

Rationale	It is important to always know the status of services, particularly critical services such as surveillance, so that mitigating actions can be taken in the event of the loss of a service. When a subscription request is made, the status of all the services must be distributed to the subscriber so that they have all the necessary information from the start, including any active service notifications and service appliance status.
Category	<Functional>

[REQ Trace]

Relationship	Linked Element Type	Identifier
<ALLOCATED_TO>	<SESAR Solution>	PJ.10-W2-93A PJ.10-W2-93B
<ALLOCATED_TO>	<Enabler>	ER APP ATC 184_ATM Data Service Provider for ATC services in a Virtual Centre context ER APP ATC 186_Virtual Centre ATSU SVC-029_Provision and Consumption of Technical Supervision Distribution Service
<ALLOCATED_TO>	<Service>	TechnicalSupervisionDistribution (PJ.32-WP3)

[REQ]

Identifier	REQ-16-03-TS-TECSUPD.0004
Title	Distribution of Service Status Updates
Requirement	When the status of a service changes, the TECSUPD service provider shall distribute the updated status of the service.
Status	<validated>
Rationale	Users need to know the status of services, particularly critical services such as surveillance, so that mitigating actions can be taken in the event of the loss of a service.
Category	<Functional>

[REQ Trace]

Relationship	Linked Element Type	Identifier
<ALLOCATED_TO>	<SESAR Solution>	PJ.10-W2-93A PJ.10-W2-93B

<ALLOCATED_TO>	<Enabler>	ER APP ATC 184_ATM Data Service Provider for ATC services in a Virtual Centre context ER APP ATC 186_Virtual Centre ATSU SVC-029_Provision and Consumption of Technical Supervision Distribution Service
<ALLOCATED_TO>	<Service>	TechnicalSupervisionDistribution (PJ.32-WP3)

[REQ]

Identifier	REQ-16-03-TS-TECSUPD.0005
Title	Distribution of Service Status Notifications
Requirement	A TECSUPD service provider shall publish service status notifications, including information, warning or error messages to subscribed users.
Status	<validated>
Rationale	Information relating to the status of the services is important to the managing of the air traffic service delivery. It may be necessary to switch to backup services to avoid interruptions or take other mitigating actions.
Category	<Functional>

[REQ Trace]

Relationship	Linked Element Type	Identifier
<ALLOCATED_TO>	<SESAR Solution>	PJ.10-W2-93A PJ.10-W2-93B
<ALLOCATED_TO>	<Enabler>	ER APP ATC 186_Virtual Centre ATSU ER APP ATC 184_ATM Data Service Provider for ATC services in a Virtual Centre context SVC-029_Provision and Consumption of Technical Supervision Distribution Service
<ALLOCATED_TO>	<Service>	TechnicalSupervisionDistribution (PJ.32-WP3)

[REQ]

Identifier	REQ-16-03-TS-TECSUPD.0006
Title	Distribution of Service Appliance Status Updates

Requirement	When the status of a service appliance changes, the TECSUPD service provider shall distribute the updated appliance status of the service to subscribed users.
Status	<validated>
Rationale	
Category	

[REQ Trace]

Relationship	Linked Element Type	Identifier
<ALLOCATED_TO>	<SESAR Solution>	PJ.10-W2-93A PJ.10-W2-93B
<ALLOCATED_TO>	<Enabler>	ER APP ATC 186_Virtual Centre ATSU ER APP ATC 184_ATM Data Service Provider for ATC services in a Virtual Centre context SVC-029_Provision and Consumption of Technical Supervision Distribution Service
<ALLOCATED_TO>	<Service>	TechnicalSupervisionDistribution (PJ.32-WP3)

4.2.1.5 Other Virtual Centre Services [PJ.32-W3-02]

Other services have been improved by PJ.32-W3-02. However, those improvements only concern details of the service payloads and do not impact the existing requirements. Therefore, those services are not detailed in this section, but their updated SDDs are provided in the Annex of this document. Those services are:

- Airspace Status Distribution
- Coordination And Transfer Management
- Correlation Distribution
- Correlation Management
- Flight Data Distribution
- Flight Data Management
- Medium Term Conflict Detection
- Medium Term Conflict Management
- Safety Net (SNET) Alert Distribution
- SSR Code Distribution
- SSR Code Management
- Technical Supervision Distribution

4.2.1.6 Functional Requirements for "Y" Architecture [PJ.32-W3-02]

[REQ]

Identifier	REQ-32-W3.02-TS-ARHY.0001
Title	Common Trajectory
Requirement	For “Y” architecture, the ADSP system shall compute a common trajectory encompassing all the ATSUs it supports, using common rules to process the various constraints (e.g. XFL, LOA rules) and ATCO inputs in accordance with the needs of its ATSUs.
Status	<in progress>
Rationale	Common Trajectory is the essence of the “Y” architecture.
Category	<Functional>

[REQ Trace]

Relationship	Linked Element Type	Identifier
<ALLOCATED_TO>	<SESAR Solution>	PJ.10-W2-93A
<ALLOCATED_TO>	<Enabler>	ER APP ATC 184_ATM Data Service Provider for ATC services in a Virtual Centre context
<ALLOCATED_TO>	<Functional block>	Trajectory Prediction and Management (PJ.10-93) Flight Planning - Lifecycle Management - Data Distribution (PJ.10-93) Coordination and Transfer (PJ.10-93)
<ALLOCATED_TO>	<System>	ADSP ATC (PJ.10-93)

[REQ]

Identifier	REQ-32-W3.02-TS-ARHY.0002
Title	LoA Common Syntax
Requirement	For “Y” architecture, the ADSP system shall assume a common syntax for defining the LOAs of the ATSUs it supports.
Status	<in progress>
Rationale	Common LoAs definition supports the common trajectory management. This common syntax means a unique grammar to express LOA rules used by all stakeholders possibly involved in the “Y” Virtual Centres.
Category	<Functional>

[REQ Trace]

Relationship	Linked Element Type	Identifier
<ALLOCATED_TO>	<SESAR Solution>	PJ.10-W2-93A
<ALLOCATED_TO>	<Enabler>	ER APP ATC 184_ATM Data Service Provider for ATC services in a Virtual Centre context
<ALLOCATED_TO>	<Functional block>	Flight Planning - Lifecycle Management - Data Distribution (PJ.10-93) Coordination and Transfer (PJ.10-93) Trajectory Prediction and Management (PJ.10-93)
<ALLOCATED_TO>	<System>	ADSP ATC (PJ.10-93)

[REQ]

Identifier	REQ-32-W3.02-TS-ARHY.0003
Title	AoR Definition
Requirement	For “Y” architecture, the ADSP system shall compute a trajectory relevant for all the ATSUs it supports by using either a common AOR or a grouping of the different AORs.
Status	<in progress>
Rationale	Common trajectory management means an overall AoR view.
Category	<Functional>

[REQ Trace]

Relationship	Linked Element Type	Identifier
<ALLOCATED_TO>	<SESAR Solution>	PJ.10-W2-93A
<ALLOCATED_TO>	<Enabler>	ER APP ATC 184_ATM Data Service Provider for ATC services in a Virtual Centre context
<ALLOCATED_TO>	<Functional block>	Coordination and Transfer (PJ.10-93) Flight Planning - Lifecycle Management - Data Distribution (PJ.10-93) Trajectory Prediction and Management (PJ.10-93)
<ALLOCATED_TO>	<System>	ADSP ATC (PJ.10-93)

[REQ]

Identifier	REQ-32-W3.02-TS-ARHY.0004
------------	---------------------------

Title	OPSUP Roles Authorization
Requirement	For “Y” architecture, ADSP system eligibility rules shall define the authorization of OPSUP roles to allocate sectors to positions in the different configuration partitions defining each ATSU it supports.
Status	<in progress>
Rationale	The way to access configurations of a shared system by specific ATSU Supervisions must be provided.
Category	<Functional>

[REQ Trace]

Relationship	Linked Element Type	Identifier
<ALLOCATED_TO>	<SESAR Solution>	PJ.10-W2-93A
<ALLOCATED_TO>	<Enabler>	ER APP ATC 184_ATM Data Service Provider for ATC services in a Virtual Centre context
<ALLOCATED_TO>	<Functional block>	Operational Supervision Data Management ER/APP ATC (PJ.10-93)
<ALLOCATED_TO>	<System>	ADSP ATC (PJ.10-93)

[REQ]

Identifier	REQ-32-W3.02-TS-ARHY.0005
Title	Sector Allocation Authorization
Requirement	For a “Y” architecture, ADSP system eligibility rules shall define the ability of an OPSUP instance to allocate sectors and positions for each of the ATSU supported by the ADSP system.
Status	<in progress>
Rationale	The way to access configurations of a shared system by specific ATSU Supervisions must be provided.
Category	<Functional>

[REQ Trace]

Relationship	Linked Element Type	Identifier
<ALLOCATED_TO>	<SESAR Solution>	PJ.10-W2-93A
<ALLOCATED_TO>	<Enabler>	ER APP ATC 184_ATM Data Service Provider for ATC services in a Virtual Centre context
<ALLOCATED_TO>	<Functional block>	Operational Supervision Data Management ER/APP ATC (PJ.10-93)

<ALLOCATED_TO>	<System>	ADSP ATC (PJ.10-93)
----------------	----------	---------------------

[REQ]

Identifier	REQ-32-W3.02-TS-ARHY.0006
Title	Managed Flights
Requirement	The ADSP system shall manage all the flight plans crossing at least one of the AORs of the ATSU's it supports.
Status	<in progress>
Rationale	The ADSP system is the unique FP provider of the ATSU's, and therefore needs to provide flight information even if a flight only concerns a single ATSU.
Category	<Functional>

[REQ Trace]

Relationship	Linked Element Type	Identifier
<ALLOCATED_TO>	<SESAR Solution>	PJ.10-W2-93A
<ALLOCATED_TO>	<Enabler>	ER APP ATC 184_ATM Data Service Provider for ATC services in a Virtual Centre context
<ALLOCATED_TO>	<Functional block>	Flight Planning - Lifecycle Management - Data Distribution (PJ.10-93)
<ALLOCATED_TO>	<System>	ADSP ATC (PJ.10-93)

[REQ]

Identifier	REQ-32-W3.02-TS-ARHY.0007
Title	Flight Information
Requirement	The ADSP system shall provide up-to-date information about all the flight plans crossing at least one of the AOIs of the ATSU's it supports.
Status	<in progress>
Rationale	The ADSP system needs to receive the Initial Flight Plans for all the ATSU's it supports.
Category	<Functional>

[REQ Trace]

Relationship	Linked Element Type	Identifier

<ALLOCATED_TO>	<SESAR Solution>	PJ.10-W2-93A
<ALLOCATED_TO>	<Enabler>	ER APP ATC 184_ATM Data Service Provider for ATC services in a Virtual Centre context
<ALLOCATED_TO>	<Functional block>	Flight Planning - Lifecycle Management - Data Distribution (PJ.10-93)
<ALLOCATED_TO>	<System>	ADSP ATC (PJ.10-93)

[REQ]

Identifier	REQ-32-W3.02-TS-ARHY.0008
Title	IFP Provision by Network Manager
Requirement	For “Y” architecture, the ADSP system shall provide the Network Manager with the view of its overall AOR, which includes all the ATSU it is in charge of.
Status	<in progress>
Rationale	NM needs to consider that the ADSP system is responsible of the AOR of all the ATSU the ADSP system supports.
Category	<Functional>

[REQ Trace]

Relationship	Linked Element Type	Identifier
<ALLOCATED_TO>	<SESAR Solution>	PJ.10-W2-93A
<ALLOCATED_TO>	<Functional block>	Support Functions Data Management ER/APP (PJ.10-93) Legacy G/G Datalink Communications (PJ.10-93)
<ALLOCATED_TO>	<System>	ADSP ATC (PJ.10-93)

[REQ]

Identifier	REQ-32-W3.02-TS-ARHY.0009
Title	Surveillance
Requirement	For “Y” architecture, the ADSP system shall use the respective surveillance infrastructure of each ATSU it supports.
Status	<in progress>
Rationale	The ADSP needs to provide a common surveillance view encompassing all its ATSU airspaces.
Category	<Functional>

[REQ Trace]

Relationship	Linked Element Type	Identifier
<ALLOCATED_TO>	<SESAR Solution>	PJ.10-W2-93A
<ALLOCATED_TO>	<Enabler>	ER APP ATC 184_ATM Data Service Provider for ATC services in a Virtual Centre context
<ALLOCATED_TO>	<Functional block>	Surveillance (PJ.10-93)
<ALLOCATED_TO>	<System>	ADSP ATC (PJ.10-93)

[REQ]

Identifier	REQ-32-W3.02-TS-ARHY.0011
Title	Datalink Logon
Requirement	For “Y” architecture, and if the ATSU supported by an ADSP system share common Datalink facilities, the ADSP system shall apply the LOGON, CONTACT and CONNECTION procedures only when entering the overall ATSU AoR and when exiting it.
Status	<in progress>
Rationale	It is not expected to apply those procedures when entering and exiting ATSU both supported by a common ADSP system.
Category	<Functional>

[REQ Trace]

Relationship	Linked Element Type	Identifier
<ALLOCATED_TO>	<SESAR Solution>	PJ.10-W2-93A
<ALLOCATED_TO>	<Enabler>	ER APP ATC 184_ATM Data Service Provider for ATC services in a Virtual Centre context
<ALLOCATED_TO>	<Functional block>	A/G Datalink Services (PJ.10-93)
<ALLOCATED_TO>	<System>	ADSP ATC (PJ.10-93)

[REQ]

Identifier	REQ-32-W3.02-TS-ARHY.0012
Title	Data Authority
Requirement	For “Y” architecture, and if the ATSU supported by an ADSP system share common Datalink facilities, the ADSP system shall maintain the same data authority when an aircraft crosses several of those ATSU.

Status	<in progress>
Rationale	It is not expected to change data authorities for a single datalink system managing several ATSU's.
Category	<Functional>

[REQ Trace]

Relationship	Linked Element Type	Identifier
<ALLOCATED_TO>	<SESAR Solution>	PJ.10-W2-93A
<ALLOCATED_TO>	<Enabler>	ER APP ATC 184_ATM Data Service Provider for ATC services in a Virtual Centre context
<ALLOCATED_TO>	<Functional block>	A/G Datalink Services (PJ.10-93)
<ALLOCATED_TO>	<System>	ADSP ATC (PJ.10-93)

4.2.1.7 Communication Infrastructure (VCCI) Requirements

4.2.1.7.1 Types of Requirements

This section specifies technical requirements on the Virtual Centre Communication Infrastructure. This includes the following requirements:

- The *Technical Interface (TI) requirements* specify the capabilities required from the communication infrastructure between ADSPs and ATSU's. These requirements are specified in section 4.2.1.3.2.
- The *Network Binding interface requirements* specify the required network protocol and access methods. These requirements are specified in section 4.2.1.3.3.
- The *Service Binding interface requirements* specify the expected way that the services use the communication service provider in terms of protocol, access method and data management. These requirements are specified in section 4.2.1.3.4.

These requirements have been produced by PJ16-03.

4.2.1.7.2 Technical Infrastructure Requirements

The analysis of the communication infrastructure performed in TRL2 phase when developing the FRD for the Virtual Centre concluded that an infrastructure supporting a SWIM Yellow Profile (YP) would fully fit the communication needs of the VC services between ADSPs and VC ATSU's.

The SWIM consists of “*standards, infrastructure and governance enabling the management of ATM information and its exchange between qualified parties via interoperable services*”.

The use of SWIM guarantees ADSPs and VC ATSU's with capabilities related to accessibility, equity, flexibility, performance, quality, integrity & security, evolution, cost, service orientation, open standards and global applicability.

The SWIM technical infrastructure (SWIM-TI) is the interoperable (runtime) infrastructure (ground/ground and air/ground) over which SWIM services are provided and ATM data are

distributed, shared and consumed. Its implementation may, depending on the specific needs profile, differ from one stakeholder to another in terms of scope and type of implementation. The requirements below define the scope of the SWIM-TI relevant for the Virtual Centre Services.

[REQ]

Identifier	REQ-16-03-TS-VCCI.0001
Title	TI Service Binding
Requirement	The VC Technical Infrastructure implementation supporting the communications between ADSPs and VC ATSUs shall be conformant to the SWIM TI YP Specification.
Status	<validated>
Rationale	This requirement aims to ensure compliance with the EUROCONTROL Yellow Profile Specification ([12]). This requirement is applicable to all VC services.
Category	<Interface>

[REQ Trace]

Relationship	Linked Element Type	Identifier
<ALLOCATED_TO>	<SESAR Solution>	PJ.10-W2-93A PJ.10-W2-93B

The SWIM YP Technical Infrastructure capabilities are broken down into profile parts. The Core Profile Part implies an infrastructure with at least a minimum set of capabilities for the secure exchange of information. Three optional Profile Parts (Extended Profile Part, Security+ and Security+2) imply additional basic and security capabilities.

The Core Profile Part includes requirements for the following capabilities:

- Messaging: common time reference, prioritise use of COTS,
- Security: overload protection, encrypted connections for remote administrative access, obscure password typing, regulation compliance, support of role based access control, least privileged principle access, automatic session termination, trusted software, verification of signed message integrity, message protocol validation, message payload validation, retrieval and validation of X.509 certificates, ECRYPT algorithms, strong passwords, audit of failed authentication request, access control restriction, satisfactory authorization, mandatory access control, inactive session termination, audit data access control, audit data reporting, cryptography key sizes, cryptographic key life-cycle management, non-recoverable password storage.
- Monitoring: hardware monitoring, monitoring alerts.
- Performance efficiency: satisfactory throughput, satisfactory transit time.

- Reliability: satisfactory availability.

[REQ]

Identifier	REQ-16-03-TS-VCCI.0002
Title	TI Profile Part
Requirement	The VC Technical Infrastructure implementation shall be conformant to the SWIM TI YP Core Profile Part Specification.
Status	<validated>
Rationale	<p>The Core Profile Part specification is a sub-specification of the SWIM TI YP that specifies the minimum set of requirements (excluding interface requirements) for the implementation of a technical infrastructure</p> <p>Requirement aims to ensure compliance with the mandatory EUROCONTROL Yellow Profile Specification CORE profile part.</p> <p>This requirement is applicable to all VC services.</p>
Category	<Interface>

[REQ Trace]

Relationship	Linked Element Type	Identifier
<ALLOCATED_TO>	<SESAR Solution>	PJ.10-W2-93A PJ.10-W2-93B

The Extended Profile Part requires the implementation of capabilities that are required in more sophisticated information exchange scenarios than those addressed by the core:

- Messaging: content based routing, subject based routing, context based routing, automatic retries, configurable routing, durable subscriptions, traffic prioritisation;
- Monitoring: service monitoring, persistent storage recording, log retention;
- Reliability: replication transparency, failure transparency, durable subscription persistency.

[REQ]

Identifier	REQ-16-03-TS-VCCI.0003
Title	TI Extended Profile Part
Requirement	When enhanced communication capabilities are required, the VC Technical Infrastructure implementation shall be conformant to the SWIM TI YP Extended Profile Part Specification.

Status	<in progress>
Rationale	Requirement aims to ensure compliance with the mandatory EUROCONTROL Yellow Profile Specification Core profile part. This requirement is applicable to the VC services that require additional capabilities in terms of messaging, monitoring and reliability.
Category	<Interface>

[REQ Trace]

Relationship	Linked Element Type	Identifier
<ALLOCATED_TO>	<SESAR Solution>	PJ.10-W2-93A
		PJ.10-W2-93B

The optional Security Parts (Security+ and Security+2) do not need to be supported. This choice might be challenged by the security analysis that will be performed in the scope of PJ.16 TR4 activities. For information, the capabilities added by the Security Profile Part are listed below:

- For Security+: Admin Console Notifications, security patching, yearly vulnerability assessment, documentation of cryptographic encryption methods, data origin authentication , documentation of cryptographic signature methods, identity and tokens documentation, audit of identity validity events, protection of information at rest, protection of audit information, audit data remote storage, audit data management reporting, audit of access requests, audit of authentication requests, audit of authorization requests.
- For Security+2: safe mode operation, safe mode description, vulnerability assessment by third-party, Cryptographic Algorithm Validation Program validated cryptographic modules, audit of cryptographic events, configuration authentication, audit of federated identity events, security assessment, denial of service protection, identity validity information exchange, attribute based access control, hardware tokens.

4.2.1.7.3 Network Interface Binding

The Network Interface Bindings define consistent and self-contained groupings of interface requirements enabling to exchange data with the network.

[REQ]

Identifier	REQ-16-03-TS-VCCI.0004
Title	TI Network Binding
Requirement	The VC service implementation shall use at least the IPv4 Unicast Network Interface Binding included in the SWIM TI YP Specification.
Status	<validated>

Rationale	<p>Requirement aims to ensure compliance with the EUROCONTROL Yellow Profile Specification [12]. At least one (or more) Network Interface Binding(s) must be required. Requirements must be expressed with the Binding Name(s) (i.e. not detailing all the requirement IDs).</p> <p>This requirement is applicable to all VC services.</p> <p>This requirement means the support of TCP, IPv4 and DNSSEC.</p>
Category	<Interface>

[REQ Trace]

Relationship	Linked Element Type	Identifier
<ALLOCATED_TO>	<SESAR Solution>	PJ.10-W2-93A PJ.10-W2-93B

4.2.1.7.4 Service Interface Binding

The Service Interface Bindings define consistent and self-contained groupings of interface requirements enabling services to exchange data between consuming and server applications. Service Interface Bindings can be differentiated from each other based on the messaging and security capabilities they provide.

The YP defines the following Service Interface Bindings:

1. WS Light,
2. WS SOAP,
3. WS SOAP With Basic Message Security,
4. WS SOAP with Message Security,
5. WS SOAP with Federated Security,
6. WS-N SOAP
7. WS-N SOAP with Basic Message Security,
8. WS-N SOAP with Message Security,
9. WS-N SOAP with Federated Security, and
10. AMQP Messaging.

Each Service Interface Binding requires the implementation of a set of communication protocols. Service Interface Bindings #1 to #9 are SOAP web-services protocols whereas AMQP is a message oriented middleware. The Table below identifies the protocols for each Service Interface Binding.

	WS (R/R)					WS-Notification (P/S)				AMQP	REST
	WS Light	WS SOAP	WS SOAP with Basic Message Security	WS SOAP with Message Security	WS SOAP with Federated Security	WS-N SOAP	WS-N SOAP with Basic Message Security	WS-N SOAP with Message Security	WS-N SOAP with Federated Security		
Transport layer											
TCP	x	x	x	x	x	x	x	x	x	x	x
Data Compression	(o)	(o)	(o)	(o)	(o)	(o)	(o)	(o)	(o)	(o)	(o)
Application layer											
HTTP	x	x	x	x	x	x	x	x	x		x
HTTP Reason Phrase Header	x	x	x	x	x	x	x	x	x		x
HTTP Status Code Header	x	x	x	x	x	x	x	x	x		x
HTTP Content Type Header	x	x	x	x	x	x	x	x	x		x
HTTP Header Transfer Encoding	x	x	x	x	x	x	x	x	x		x
HTTP Header Content Encoding	x	x	x	x	x	x	x	x	x		x
HTTP method: POST		x	x	x	x	x	x	x	x		x
HTTP methods: OPTIONS, GET, PUT, DELETE											x
Data representation											
XML		x	x	x	x	x	x	x	x		x
XML Schema Validation		x	x	x	x	x	x	x	x		x
Other representations											x
Web services											
SOAP		x	x	x	x	x	x	x	x		
MTOM		x	x	x	x	x	x	x	x		
WSDL		x	x	x	x	x	x	x	x		
WSI		x	x	x	x	x	x	x	x		
WS Reliable Messaging		(o)	(o)	(o)	(o)	(o)	(o)	(o)	(o)		
WS Notification						x	x	x	x		
Publish-Subscribe DDS											
Security											
TLS	x	x	x			x	x				x
HTTP over TLS	x	x	x			x	x				
TLS Authentication	x	x				x					
TLS Mutual Authentication			x				x				
WS Security Username Token						x	x				
WS-I Security			x	x	x	x	x	x	x		
WS Policy			(o)	(o)	(o)	(o)	(o)	(o)	(o)		
SOAP Message Security			x	x	x	x	x	x	x		
WS Security X509				x				x			
XML Signature				x	x			x	x		
XML Encryption				x	x			x	x		
SOAP Encryption				(o)	(o)			(o)	(o)		
SOAP Message Signing				x	x			x	x		
WS Security Token Profiles					x				x		
WS Federation					x				x		
WS Trust					x				x		
WS Addressing					x				x		
WS Secure Conversation					x				x		
DDS Security											
AMQP											x
AMQP Content Encoding Header											x
AMQP Content Type Header											x
AMQP Transport Security Authentication											x

Table 17: [VCCI] Protocols / YP Service Interface bindings mapping

An alternative to SOAP web-services is REST-based services. SOAP allows XML formatted data to be transferred using specific internet protocols whereas REST does not mandate XML formatted data nor require any additional protocol over https. In SOAP, the description of the services (data structure, bindings, extensions, etc.) are described in WSDL and discovered dynamically. REST will be chosen for simple request/response transactions with no need of specific extension. A mix SOAP and REST based services is possible.

Some Service Interface Bindings mandate the encoding rules to be used to encode/decode the application data. Unlike SOAP-based service interface bindings that mandate XML, AMQP and REST allow alternative data formats. In AMQP, the data format can be for instance XML or Protobuf. It can be either known in advance by design, or be dynamically identified in the AMQP message itself within the content-type header field.

For the VC service subscription, a Request/Reply interface is recommended. The subscription interface can be implemented using a simple SOAP or a REST based service binding. AMQP is also a possible technical solution.

The transaction type and distribution type VC services that require enhanced communication services and a publication exchange pattern can be realised using an AMQP or WS-N binding.

[REQ]

Identifier	REQ-16-03-TS-VCCI.0005
Title	TI Service Binding for subscription services interfaces
Requirement	<p>The subscription service interfaces shall use one of the following Service Interface:</p> <ul style="list-style-type: none"> • SWIM TI YP Specification WS-LIGHT or REST, • SWIM TI YP Specification WS-SOAP, • AMQP.
Status	<validated>
Rationale	<p>At least one (or more) Service Interface Binding(s) must be required. Requirements must be expressed with the Binding Name(s) (i.e. not detailing all the requirement IDs).</p> <p>WS-Light and REST-compliant Web services allow requesting systems to access and manipulate textual representations of Web resources using a uniform and predefined set of stateless operations.</p> <p>REST offers no built-in security features, encryption or session management. These can be added by building on top of HTTP. Username/password can be used for security. For encryption, REST can be used on top of HTTPS (secure sockets).</p> <p>WS-SOAP interface binding is meant to support a SOAP based interface.</p> <p>Note. The choice of the Service Interface Binding has an impact on the design and development of the service. For the PJ.16-03 exercises, AMQP is being selected.</p>
Category	<Interface>

[REQ Trace]

Relationship	Linked Element Type	Identifier
<ALLOCATED_TO>	<SESAR Solution>	PJ.10-W2-93A PJ.10-W2-93B

[REQ]

Identifier	REQ-16-03-TS-VCCI.0006
------------	------------------------

Title	TI Service Binding for transaction and distribution type service interfaces
Requirement	<p>The transaction-type and distribution-type service interfaces shall use one of the following Service Interface Bindings included in the SWIM TI YP Specification:</p> <ul style="list-style-type: none"> • AMQP, • WS-N SOAP with Basic or Message Security
Status	<validated>
Rationale	<p>At least one (or more) Service Interface Binding(s) must be required. Requirements must be expressed with the Binding Name(s) (i.e. not detailing all the requirement IDs).</p> <p>Note. The choice of the Service Interface Binding has an impact on the design and development of the service. For the Project exercises, AMQP is being selected.</p>
Category	<Interface>

[REQ Trace]

Relationship	Linked Element Type	Identifier
<ALLOCATED_TO>	<SESAR Solution>	PJ.10-W2-93A PJ.10-W2-93B

4.2.2 Non-Functional Requirements

The Non-Functional Requirements (NFR) fall into the 8 NFR Categories:

3. Safety,
4. Security,
5. Performance & Response Times,
6. Reliability (Operational and Business Resilience including Contingency),
7. Data (including accuracy of data and data reporting),
8. Adaptability,
9. Maintainability,
10. Regulation.

Safety NFRs have been derived from the Safety Assessment Report and will not be contained within this section.

4.2.2.1 Time Performance Requirements

4.2.2.1.1 Time Performance Model

In the Virtual Centre (VC) environment, performance requirements are provided for human and technical VC elements. It is important to agree on a clear definition and boundary between the various VC elements on which performance requirements will be defined on.

The figure below presents the reference model used to define times and assign them to the VC architecture components.

The VC architecture is made of 3 separate domains: the ADSP, the VC ATSU and the NET domain.

- The VC ATSU domain

The VC ATSU domain comprises the controller and the VC ATSU system. The VC ATSU system consists of the Controller Working Position HMIs, the VC ATSU processing system in charge of the operational processing of the data, the system that operates the client part of the VC services, and finally the communication stack supporting the communications with the ADSP.

- The ADSP domain

The ADSP domain comprises the processing system in charge of the operational processing of the data, the system that operates the server part of the VC services (or service provider), and finally the communication stack supporting the communications with the VC ATSU.

- The NET domain

The NET domain comprises the ground network infrastructure and all the embedded systems (as message routers, DNS systems, Security Systems, etc...) required to provide reliable and secure communication between the ADSP and the VC ATSU.

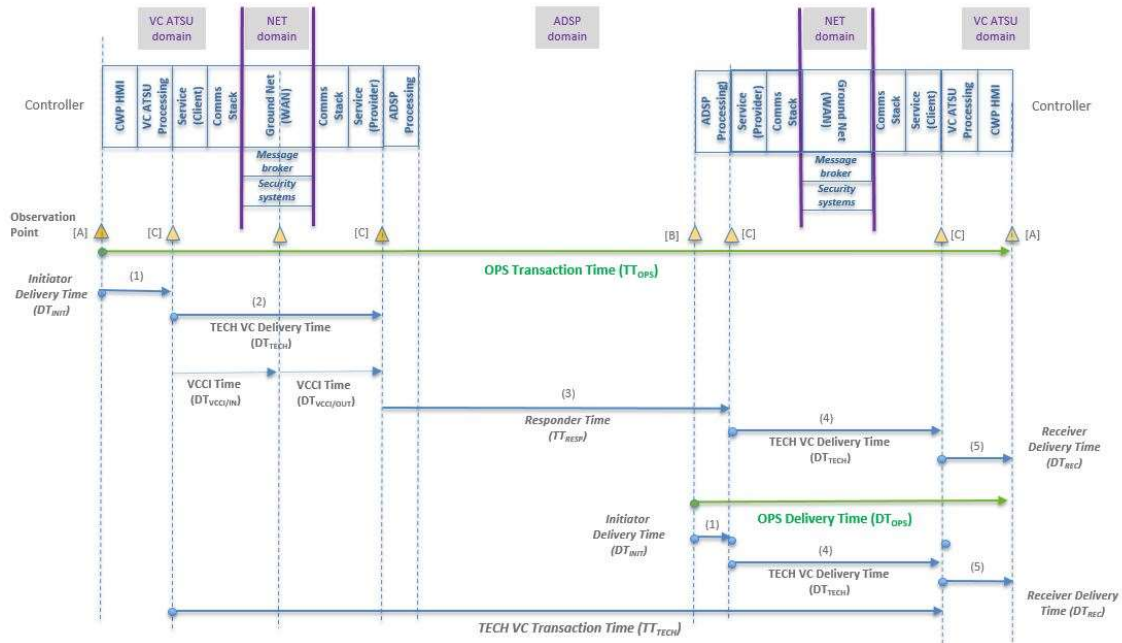

Figure 19: Virtual Centre – Performance Model

The **OPS Transaction time (TT_{OPS})** is defined as the time to complete a two-ways exchange, initiated by the controller at the VC ATSU side and including the time for processing the response from the ADSP.

Two values are significant: the **Maximum Transaction Time** is the maximum acceptable transaction time, after which the initiator is required to revert to an alternative / fallback procedure. The **Nominal Transaction Time** is the time at which 95 percent of all transactions are required to be completed.

The OPS Transaction Times are apportioned to the following VC elements:

1. The **Initiator Delivery Time (DT_{INIT})** includes the composition and the operational processing of it. This is the time allocated to the CWP HMI and the data processing systems.
2. The **TECH VC Delivery Time (DT_{TECH})** is the time associated to the VC service from the VC ATSU to the ADSP or from the ADSP to the ATSU ,
3. The **Responder Time (TT_{RESP})** which can be of 2 types:
 - a. The ADSP locally processes the data and responds;
 - b. The ADSP needs to communicate with external systems to process the data and respond.
4. The **TECH VC Delivery Time (DT_{TECH})** is the time associated to the VC service from the ADSP to the VC ATSU,
5. The **Receiver Delivery Time (DT_{REC})** includes the recognition (receiver) of the message and the operational processing of it. This is the time allocated to the CWP HMI and the data processing systems.

The **TECH Transaction Time (TT_{TECH})** is the time associated to the VC service, excluding the Initiator time but including the ADSP **Responder time (TT_{RESP})** Only in case the Responder Time does not include an external transaction (case A. above), the TT_{TECH} will be independent of human interaction and external systems. It will be representative of the VC system and can be easily monitored. Otherwise, this time will depends on external systems and will be difficult to analyse.

Delivery Times

The **OPS Delivery Time (DT_{OPS})** is defined as the time to complete a one-way exchange, initiated by the availability of the data to be sent at the ADSP side and including the display processing at the CWP. The OPS Delivery Times are apportioned to the following VC elements:

1. The **Initiator Delivery time (DT_{INIT})** includes the composition (initiator) the message and the operational processing of it.
2. The **TECH VC Delivery Time (DT_{TECH})** is the time associated to the VC service.
3. The **Receiver Delivery Time (DT_{REC})**.

Network Transit times

Another technical delivery time (**DT_{VCCI}**) is specifically defined for the Virtual Centre architecture, corresponding to the transit delay between the ADSP system (or the VC ATSU system) and an intermediate system within the VCCI infrastructure (e.g. an AMQP broker or a Security system). The **DT_{VCCI/IN}** corresponds to the time from the ADSP/VC ATSU to this intermediate system whereas **DT_{VCCI/OUT}** will be the one from the intermediate system to the ADSP/VC ATSU.

Observation points can be inserted in the Virtual Centre components to monitor the times identified above:

- [A] At the CWP level, times associated with input controller on the screen;
- [B] In the ADSP, available time of data intended to be sent to the CWP;
- [C] In the ADSP and VC ATSU, time at which VC service are invoked or received;
- [D] In the Communication System router (e.g. AMQP broker), the time a message is received and/or the time the message is re-forwarded.

4.2.2.1.2 Identification of Transaction and Delivery Times per VC service

This section identifies the operational and technical times for each Virtual Centre service for which performance requirements could be defined.

These times are assigned a profile among a small set of fixed performance categories corresponding to more or less stringent time requirements.

The Table below identifies the time profiles.

Time Profile	Applicability	Order of Magnitude
Very time critical	One-way or two-ways operational or technical transactions that have to be completed in a stringent emergency. Almost immediately, delay not noticeable.	Almost immediately, delay not noticeable, milliseconds
Time critical	One-way or two-ways operational or	Few seconds (0-5)

	technical transactions that have to be completed in a safety critical context (e.g. in notification phase).	
Time sensitive	One-way or two-ways operational or technical transactions that have to be completed in a time sensitive context (e.g. in co-ordination phase).	Half a minute
Not time sensitive	One-way or two-ways operational or technical transactions that have to be completed in a time relaxed context (e.g. in planning phase).	One minute

Table 18: Categories of VC Service Response and Transit Times

The identification and qualification of the times per service can be found in Appendix B. From the analysis of each service, the list of applicable transaction and delivery times applicable in the context of the Virtual Centre can be established as shown in the Table below.

Identifier	Type	Definition	Associated VC Service times	Associated TS/IRS requirement
OPS Times				
TT-OPS-001	Time 'critical' Operational Transaction time	Time for the controller to request the VC ATSU to request the ADSP to perform a time critical action and get the result displayed to the ATCO.	TT-OPS-CT-001 TT-OPS-CT-002 TT-OPS-FDM-003 TT-OPS-VCM-002 TT-OPS-VCM-003 TT-OPS-SSRCM-001	REQ-16-03-TS-TIME.0003
TT-OPS-002	Time 'sensitive' Operational Transaction time	Time for the controller to request the VC ATSU to request the ADSP to perform a time sensitive action and get the result displayed to the ATCO.	TT-OPS-FDM-001 TT-OPS-FDM-002 TT-OPS-VCM-001 TT-OPS-ASM-001 TT-OPS-TBSM-001 TT-OPS-TBSM-002	REQ-16-03-TS-TIME.0003

TT-OPS-003	'Not time sensitive' Operational Transaction time	Time for the controller to request the VC ATSU to request the ADSP to perform a non time sensitive action and get the result displayed to the ATCO.	TT-OPS-OPCONFM-001	REQ-16-03-TS-TIME.0003
DT-OPS-001	Time 'critical' Operational Delivery Time	Time between the time critical data is available in the ADSP and is displayed on the ATCO CWP.	DT-OPS-FDD-001 DT-OPS-VCD-001 DT-OPS-SDD-001 DT-OPS-SSRCD-001	REQ-16-03-TS-TIME.0004
DT-OPS-002	Time 'sensitive' Operational Delivery Time	Time between the time sensitive data is available in the ADSP and is displayed on the ATCO CWP.	DT-OPS-VCD-001 DT-OPS-OPCONFD-001 DT-OPS-SSRD-002	REQ-16-03-TS-TIME.0004
TECH Times				
TT-TECH-001	Time 'critical' Technical Transaction Time	Time for the ATSU to send a request to the ADSP and receive a technical response from the ADSP.	TT-TECH-CT-001 TT-TECH-FDM-001 TT-TECH-VCM-001 TT-TECH-SDD-001 TT-TECH-SSRCM-001	REQ-16-03-TS-TIME.0005
TT-TECH-002	Time 'sensitive' Technical Transaction Time	Time for the ATSU to send a request to the ADSP and receive a technical response from the ADSP.	TT-TECH-OPCONFD-001 TT-TECH-ASD-001 TT-TECH-TBSD-001 TT-TECH-TBSD-002 TT-TECH-ASM-001	No requirement, more stringent requirement (REQ-16-03-TS-TIME.0005) will apply.
DT-TECH-001	Time 'critical' Technical Delivery Time	Time for the ADSP to deliver "time critical" data to the VC ATSU.	DT-TECH-FDD-001 DT-TECH-VCD-001 DT-TECH-SDD-001	REQ-16-03-TS-TIME.0006
DT-TECH-002	Time 'sensitive'	Time for the ADSP to deliver "time sensitive"	DT-TECH-OPCONFD-001	No requirement, more stringent requirement (REQ-

	Technical Delivery Time	data to the VC ATSU.		16-03-TS-TIME.0006) will apply.
--	-------------------------	----------------------	--	---------------------------------

Table 19: List of VC Service Response and Transit Times

4.2.2.1.3 OPS Time Requirements

Operational Performance requirements will not be expressed in this TS/IRS document. Operational time requirements are by definition operation-driven, for instance times allocated to complete a CTM, data link or operational configuration transaction cannot be the same. Moreover, operational time requirements are usually developed by each ANSP and can differ from one ANSP to another, from one environment to another. These requirements will be expressed from an end-to-end perspective in SPR documents (outside the scope).

The chosen approach to handle performance requirements in the VC environment is therefore to address the impact of the transition to Virtual Centre on performance. The Virtual Centre is an enabler architecture which must not impair the ability of the end-users to perform their activities, so VC should not degrade the overall performances.

[REQ]

Identifier	REQ-16-03-TS-TIME.0001
Title	Acceptable Time degradation due to Virtual Centre
Requirement	The time delay induced by the Virtual Centre topology, namely the operation of WAN-connected ADSPs and VC ATSUs, shall not negatively affect the ability to perform the ATS services.
Status	<validated>
Rationale	This general performance requirement states the basic constraint that the transition from a LAN-based to a WAN-based connection of the CWP to the ADSP does not affect significantly the ATS operation.
Category	<Performance>

[REQ Trace]

Relationship	Linked Element Type	Identifier
<ALLOCATED_TO>	<SESAR Solution>	PJ.10-W2-93A PJ.10-W2-93B

Moreover, as the main assumption in the supporting Use Case addressed by this TS/IRS is that the ATS concept of operation is not changed by the Virtual Centre architecture, the VC services do not introduce new operational time requirements as such. On the contrary, the implementation of the VC services and the supporting communication infrastructure is in such a way that the operational requirements of the end users, i.e. the controllers, are fully met.

[REQ]

Identifier	REQ-16-03-TS-TIME.0002
Title	Compliance with end-users performance requirements
Requirement	Implementation of the VC services and the underlying communication infrastructure shall support the operational time requirements expressed by the end-users.
Status	<validated>
Rationale	<p>This general performance requirement states that the VC architecture must support the operational performance requirements expressed in applicable SPRs.</p> <p>The migration towards the Virtual Centre must preserve as much as possible the level of performance of the current systems. In other words, the performance degradation induced by the migration to the Virtual Centre environment should not impair the operational capability.</p>
Category	<Performance>

[REQ Trace]

Relationship	Linked Element Type	Identifier
<ALLOCATED_TO>	<SESAR Solution>	PJ.10-W2-93A PJ.10-W2-93B

[REQ]

Identifier	REQ-16-03-TS-TIME.0003
Title	Maximum acceptable degradation of operational transaction times
Requirement	The difference of an operational transaction time between a CWP and a remote CWP in a VC architecture shall be less than OPS_TT_DELTA_VALUE seconds or OPS_TT_DELTA_PERCENT in 99% of cases.
Status	<validated>

Rationale	<p>The order of magnitude of the observed difference will be assessed during the validation exercises. Whether this time degradation is acceptable from an operational point of view or not is outside the scope of PJ.16-03. This will need an assessment by operational staff.</p> <p>An engineering proposed value for OPS_TT_DELTA_VALUE could be 0,5 second and 10% for OPS_TT_DELTA_PERCENT.</p>
Category	<Performance>

[REQ Trace]

Relationship	Linked Element Type	Identifier
<ALLOCATED_TO>	<SESAR Solution>	PJ.10-W2-93A PJ.10-W2-93B

[REQ]

Identifier	REQ-16-03-TS-TIME.0004
Title	Maximum acceptable degradation of operational delivery times
Requirement	The difference of an operational transaction time between a CWP and a remote CWP shall be less than OPS_DT_DELTA_VALUE seconds or OPS_DT_DELTA_PERCENT in 99% of cases.
Status	<validated>
Rationale	<p>The order of magnitude of the observed difference will be assessed during the validation exercises. Whether this time degradation is acceptable from an operational point of view or not is outside the scope of PJ.16-03. This will need an assessment by operational staff.</p> <p>An engineering proposed value for OPS_DT_DELTA_VALUE could be 0,5 second and 10% for OPS_DT_DELTA_PERCENT.</p> <p>Performance.</p>
Category	<Performance>

[REQ Trace]

Relationship	Linked Element Type	Identifier
<ALLOCATED_TO>	<SESAR Solution>	PJ.10-W2-93A

		PJ.10-W2-93B
--	--	--------------

4.2.2.1.4 TECH Time Requirements

The following requirements address the most stringent times identified in the VC services.

[REQ]

Identifier	REQ-16-03-TS-TIME.0005
Title	Technical Transaction Time (Time Critical)
Requirement	All transactions for service subscription and technical responses to CTM (transfer), FDM (ATC Instructions) and VCM requests (call establishment) shall be completed complying with time profile for Time Critical transactions.
Status	<validated>
Rationale	The time profile for time critical two-way transactions will be evaluated and refined during the validation exercises.
Category	<Performance>

[REQ Trace]

Relationship	Linked Element Type	Identifier
<ALLOCATED_TO>	<SESAR Solution>	PJ.10-W2-93A PJ.10-W2-93B

[REQ]

Identifier	REQ-16-03-TS-TIME.0006
Title	Technical Delivery Time (Time Critical)
Requirement	All deliveries of FDD flight plan, Voice Information Data and surveillance data between ADSP and VC ATSU shall be completed complying with the time profile defined for Time Critical.
Status	<validated>
Rationale	The time profile for time critical one-way transaction will be evaluated and refined during the validation exercises.
Category	<Performance>

[REQ Trace]

Relationship	Linked Element Type	Identifier
<ALLOCATED_TO>	<SESAR Solution>	PJ.10-W2-93A
		PJ.10-W2-93B

4.2.2.1.5 Preview/Operational Switch Requirements

The **SP-VC-CWP-switch-to-preview-time** is the time duration between the moment the switch to preview mode is activated and the moment the preview mode is effective on the CWP.

The **SP-VC-CWP-switch-to-operational-time** is the time duration between the moment the switch to operational mode is activated and the moment the CWP entered in operational mode.

[REQ]

Identifier	REQ-10-W2.93-TS-DTP.0001
Title	Time for Switching to Preview Mode
Requirement	The CWP of the receiving ATSU shall switch to preview mode within SP-VC-CWP-switch-to-preview-time time interval.
Status	<in progress>
Rationale	Switch to preview mode performances for the receiving CWPs.
Category	<Performance>

[REQ Trace]

Relationship	Linked Element Type	Identifier
<ALLOCATED_TO>	<SESAR Solution>	PJ.10-W2-93A
		PJ.10-W2-93B
<SATISFIES>	< ATMS Requirement>	REQ-PJ.10-W2.93-SPRINTEROP-0029

[REQ]

Identifier	REQ-10-W2.93-TS-DTP.0002
Title	Time for Switching to Operational Mode
Requirement	The CWP of the receiving ATSU shall switch to operational mode within SP-VC-CWP-switch-to-operational-time time interval.
Status	<in progress>
Rationale	Switch to operational mode performances for the receiving CWPs.
Category	<Performance>

[REQ Trace]

Relationship	Linked Element Type	Identifier
<ALLOCATED_TO>	<SESAR Solution>	PJ.10-W2-93A
		PJ.10-W2-93B
<SATISFIES>	< ATMS Requirement>	REQ-PJ.10-W2.93-SPRINTEROP-0031

4.2.2.2 Safety Requirements

PJ.10-W2-93 Safety Assessment is based upon work, deliverables and achievements that have been made available by SESAR2020 Wave 1 PJ.16-03 [38].

Within PJ.10-W2-93, the Safety Requirements have been defined following the SESAR Safety Reference Materials [26] and considering a twofold approach:

- a success approach which is concerned with the safety of the Solution operations in the absence of failure within the end-to-end Solution functional system, encompassing both Normal operation and Abnormal conditions,
- a conventional failure approach which is concerned with the safety of the Solution operations in the event of failures within the end-to-end Solution functional system.

Also, the allocation of a Service Assurance Level (SAL) for all services has been done in accordance with the hazard identification and analysis made in the Safety Assessment Report (SAR) [39]. Loss of service is the failure mode when specific services are lost, it means that the overall capability to manage traffic has been lost. The loss of a specific service results in occurrence of specific hazards. The analysis made in the SAR reports the highest Severity Class for the identified hazards (i.e. MAC-SC2a, MAC-SC2b, MAC-SC3). In order to ensure the mitigation effectiveness, various safety requirements have been introduced. For more information on the derivation of the safety requirements, please refer to the Safety Assessment Report [39].

[REQ]

Identifier	REQ-PJ.10-W2.93-TS-SAF001
Title	Coordination & Transfer Management SAL3
Requirement	Coordination & Transfer Management service shall have Service Assurance Level (SAL) SAL3 after safety mitigation.
Status	<in progress>
Rationale	Requirement derived to ensure mitigation effectiveness in case of loss of C&T. Requirement related to OH01, OH02 in the SAR.
Category	<Safety>

[REQ Trace]

Relationship	Linked Element Type	Identifier

<ALLOCATED_TO>	<SESAR Solution>	PJ.10-W2-93A PJ.10-W2-93B
<ALLOCATED_TO>	<Enabler>	SVC-015_Provision and Consumption of Arrival Sequence Management Service
<ALLOCATED_TO>	<Service>	CoordinationAndTransferManagement (PJ.32-WP3)

[REQ]

Identifier	REQ-PJ.10-W2.93-TS-SAF002
Title	Flight Data Distribution & Management SAL3
Requirement	Flight Data Distribution & Management services shall have Service Assurance Level (SAL) SAL3 after safety mitigation.
Status	<in progress>
Rationale	Requirement derived to ensure mitigation effectiveness in case of loss of FDD/FDM. Requirement related to OH01, OH02 in the SAR.
Category	<Safety>

[REQ Trace]

Relationship	Linked Element Type	Identifier
<ALLOCATED_TO>	<SESAR Solution>	PJ.10-W2-93A PJ.10-W2-93B
<ALLOCATED_TO>	<Enabler>	SVC-008_Provision and Consumption of FlightDataDistribution Service in the context of Virtual Centres. SVC-009_Provision and Consumption of FlightDataManagement Service in the context of Virtual Centres
<ALLOCATED_TO>	<Service>	FlightDataDistribution (PJ.32-WP3) FlightDataManagement (PJ.32-WP3)

[REQ]

Identifier	REQ-PJ.10-W2.93-TS-SAF003
Title	Surveillance SAL3
Requirement	Surveillance service shall have Service Assurance Level (SAL) SAL3 after safety mitigation.
Status	<in progress>

Rationale	Requirement derived to ensure mitigation effectiveness in case of loss of surveillance. Requirement related to OH03 in the SAR.
Category	<Safety>

[REQ Trace]

Relationship	Linked Element Type	Identifier
<ALLOCATED_TO>	<SESAR Solution>	PJ.10-W2-93A PJ.10-W2-93B
<ALLOCATED_TO>	<Enabler>	SVC-028_Provision and Consumption of Surveillance Data Distribution Service
<ALLOCATED_TO>	<Service>	SurveillanceDataDistribution

[REQ]

Identifier	REQ-PJ.10-W2.93-TS-SAF004
Title	Voice Communication Distribution & Management SAL3
Requirement	Voice Communication Distribution & Management service shall have Service Assurance Level (SAL) SAL3 after safety mitigation.
Status	<in progress>
Rationale	Requirement derived to ensure mitigation effectiveness in case of loss of VCD/VCM. Requirement related to OH01, OH02, OH03 in the SAR.
Category	<Safety>

[REQ Trace]

Relationship	Linked Element Type	Identifier
<ALLOCATED_TO>	<SESAR Solution>	PJ.10-W2-93A PJ.10-W2-93B
<ALLOCATED_TO>	<Enabler>	SVC-033_Provision and Consumption of Voice Comm Information Distribution Service SVC-034_Provision and Consumption of Voice Comm Management Service
<ALLOCATED_TO>	<Service>	VoiceCommManagement VoiceCommInformationDistribution

[REQ]

Identifier	REQ-PJ.10-W2.93-TS-SAF005
Title	Correlation Distribution & Management SAL3
Requirement	Correlation Distribution & Management services shall have Service Assurance Level (SAL) SAL3 after safety mitigation.
Status	<in progress>
Rationale	Requirement derived to ensure mitigation effectiveness in case of loss of Correlation Distribution & Management. Requirement related to OH01, OH02 in the SAR.
Category	<Safety>

[REQ Trace]

Relationship	Linked Element Type	Identifier
<ALLOCATED_TO>	<SESAR Solution>	PJ.10-W2-93A PJ.10-W2-93B
<ALLOCATED_TO>	<Enabler>	SVC-016_Provision and Consumption of Correlation Distribution Service SVC-017_Provision and Consumption of Correlation Management Service
<ALLOCATED_TO>	<Service>	CorrelationManagement CorrelationDistribution (PJ.32-WP3)

[REQ]

Identifier	REQ-PJ.10-W2.93-TS-SAF006
Title	Services SAL4
Requirement	Monitor Aids, Operational Supervisor, Secondary Surveillance Radar, Safety Nets, Technical Supervisor services shall have Service Assurance Level (SAL) SAL4 after safety mitigation.
Status	<in progress>
Rationale	Requirement derived to ensure mitigation effectiveness in case of loss of Monitor Aids, Operational Supervisor, Secondary Surveillance Radar, Safety Nets, Technical Supervisor services. Requirement related to OH01, OH02, OH03, OH04, OH05, OH06 in the SAR.
Category	<Safety>

[REQ Trace]

Relationship	Linked Element Type	Identifier

<ALLOCATED_TO>	<SESAR Solution>	PJ.10-W2-93A PJ.10-W2-93B
<ALLOCATED_TO>	<Enabler>	SVC-029_Provision and Consumption of Technical Supervision Distribution Service SVC-020_Provision and Consumption of Monitoring Aids Distribution Service SVC-023_Provision and Consumption of Safety Net (SNET) Alert Distribution Service SVC-022_Provision and Consumption of Operational Configuration Management Service SVC-021_Provision and Consumption of Operational Configuration Distribution Service
<ALLOCATED_TO>	<Service>	MonitoringAidsDistribution (PJ.32-WP3) SNETAlertDistribution OperationalConfigurationDistribution (PJ.10-93) OperationalConfigurationManagement (PJ.10-93) TechnicalSupervisionDistribution (PJ.32-WP3)

[REQ]

Identifier	REQ-PJ.10-W2.93-TS-SAF007
Title	Service Continuity
Requirement	All services shall be segregated to ensure continuity of other services in case of malfunction of one specific service.
Status	<in progress>
Rationale	Segregated services will protect from the likelihood of services discontinuity in case of malfunction or specific attacks. This will prevent the controller to have access to all functionality required to safely manage traffic.
Category	<Safety>

[REQ Trace]

Relationship	Linked Element Type	Identifier
<ALLOCATED_TO>	<SESAR Solution>	PJ.10-W2-93A PJ.10-W2-93B

<ALLOCATED_TO>	<Enabler>	ER APP ATC 184_ATM Data Service Provider for ATC services in a Virtual Centre context ER APP ATC 185_ATM Data Service Provider for Voice services in a Virtual Centre context
----------------	-----------	--

[REQ]

Identifier	REQ-PJ.10-W2.93-TS-SAF008
Title	Service SAL
Requirement	All services shall have assigned a Service Assurance Level (SAL) to ensure proper Assurance Level of the service.
Status	<in progress>
Rationale	Requirement derived to ensure mitigation effectiveness in case of loss of service. Requirement related to OH01, OH02, OH03, OH04, OH05, OH06 in the SAR.
Category	<Safety>

[REQ Trace]

Relationship	Linked Element Type	Identifier
<ALLOCATED_TO>	<SESAR Solution>	PJ.10-W2-93A PJ.10-W2-93B
<ALLOCATED_TO>	<Enabler>	ER APP ATC 184_ATM Data Service Provider for ATC services in a Virtual Centre context ER APP ATC 185_ATM Data Service Provider for Voice services in a Virtual Centre context

[REQ]

Identifier	REQ-PJ.10-W2.93-TS-SAF009
Title	Technical Training
Requirement	Concerned technical staff shall receive appropriate training to perform shutdown/restart/reboot of operational equipment.
Status	<in progress>
Rationale	Lack of training increases workload on tasks that could have been completed easier with less time with training and proper documentation.
Category	<Safety>

[REQ Trace]

Relationship	Linked Element Type	Identifier
<ALLOCATED_TO>	<SESAR Solution>	PJ.10-W2-93A
		PJ.10-W2-93B
		PJ.10-W2-93C

[REQ]

Identifier	REQ-PJ.10-W2.93-TS-SAF010
Title	Tool Support
Requirement	The delegation of ATS provision shall be supported by the CWP (ATS and Voice).
Status	<in progress>
Rationale	CWPs used for the delegation of the ATS provision on delegating and receiving side are designed to enable smooth and save delegation process and transfer of responsibility between delegating and receiving ATC sectors.
Category	<Safety>

[REQ Trace]

Relationship	Linked Element Type	Identifier
<ALLOCATED_TO>	<SESAR Solution>	PJ.10-W2-93A
		PJ.10-W2-93B
		PJ.10-W2-93C
<ALLOCATED_TO>	<Enabler>	ER APP ATC 218_Management in the VC ATSU of Delegation of ATS provision between ATUs with Dynamic AoRs in a Y-Architecture
		ER APP ATC 195_Management in the VC ATSU of Delegation of ATS Provision between ATUs with Static AoRs for Y-Architecture
		ER APP ATC 196_Management in the VC ATSU of Delegation of ATS provision between ATUs with Dynamic AoRs for U-Architecture
		ER APP ATC 215_Management in the VC ATSU of Delegation of ATS Provision between ATUs with Static AoRs in a D-Architecture

[REQ]

Identifier	REQ-PJ.10-W2.93-TS-SAF011
------------	---------------------------

Title	System support for delegation abort
Requirement	The operational Supervisor of receiving ATSU shall be supported by the system to abort the ongoing delegation.
Status	<in progress>
Rationale	In order to ensure system consistency in case of an aborted delegation, the system needs to be designed to safely revert back to the state before the delegation was.
Category	<Safety>

[REQ Trace]

Relationship	Linked Element Type	Identifier
<ALLOCATED_TO>	<SESAR Solution>	PJ.10-W2-93A
		PJ.10-W2-93B
		PJ.10-W2-93C
<ALLOCATED_TO>	<Enabler>	SVC-022_Provision and Consumption of Operational Configuration Management Service
		SVC-021_Provision and Consumption of Operational Configuration Distribution Service

[REQ]

Identifier	REQ-PJ.10-W2.93-TS-SAF012
Title	Reception of ATS provision
Requirement	A receiving ATSU shall be appropriately equipped and staffed in order to provide ATS in the pre-defined airspace of the delegating ATSU.
Status	<in progress>
Rationale	The airspace which is subject to reception of provision of ATS is precisely defined in the delegation scenarios and procedures and in the supporting technical systems and its full definition is a part of the Delegation Agreement. There cannot be ambiguity about the exact volume of airspace being subject to delegation since this definition directly affects safety, regulatory (licensing of ATCOs) and technical (system design and adaptation) aspects of the delegation.
Category	<Safety>

[REQ Trace]

Relationship	Linked Element Type	Identifier
<ALLOCATED_TO>	<SESAR Solution>	PJ.10-W2-93A
		PJ.10-W2-93B
		PJ.10-W2-93C

[REQ]

Identifier	REQ-PJ.10-W2.93-TS-SAF013
Title	Activation of Rx frequency at delegating ATSU
Requirement	The delegating ATCO team shall switch the frequency of the delegated sector from Tx/Rx to Rx when switching from operational mode to preview mode in the delegating ATSU.
Status	<in progress>
Rationale	After the receiving ATCO team has taken over responsibility of the delegated sector, the delegating ATCO team remains in preview mode and listens to the sector frequency for a time defined in the delegation agreement. This is a safety measure to quickly take back control when problems occur at the receiving ATSU.
Category	<Safety>

[REQ Trace]

Relationship	Linked Element Type	Identifier
<ALLOCATED_TO>	<SESAR Solution>	PJ.10-W2-93A
		PJ.10-W2-93B
		PJ.10-W2-93C
<ALLOCATED_TO>	<Enabler>	SVC-033_Provision and Consumption of Voice Comm Information Distribution Service
		SVC-034_Provision and Consumption of Voice Comm Management Service

[REQ]

Identifier	REQ-PJ.10-W2.93-TS-SAF014
Title	Control systems of ATSU
Requirement	ATSEP of the ATSU shall be able to control systems running at the ATSU, including network connection to ADSP at all times.
Status	<in progress>

Rationale	The ATSEP of the ATSU in control of all the systems deployed needs the ability to issue control actions in order to ensure the functioning of the systems.
Category	<Safety>

[REQ Trace]

Relationship	Linked Element Type	Identifier
<ALLOCATED_TO>	<SESAR Solution>	PJ.10-W2-93A
		PJ.10-W2-93B
		PJ.10-W2-93C
<ALLOCATED_TO>	<Enabler>	SVC-029_Provision and Consumption of Technical Supervision Distribution Service

[REQ]

Identifier	REQ-PJ.10-W2.93-TS-SAF015
Title	Coordination and synchronization messages
Requirement	In case of contingency, coordination and synchronization messages shall be exchanged between ATSUs.
Status	<in progress>
Rationale	Depending on the contingency policy in place between two or more ATSUs, when a contingency occurs, coordination and synchronization messages shall be exchanged.
Category	<Safety>

[REQ Trace]

Relationship	Linked Element Type	Identifier
<ALLOCATED_TO>	<SESAR Solution>	PJ.10-W2-93A
		PJ.10-W2-93B
		PJ.10-W2-93C

[REQ]

Identifier	REQ-PJ.10-W2.93-TS-SAF016
Title	Integrity / Reliability TSSR loss of service: a/c management for receiving ATSU

Requirement	The frequency of occurrence of Loss of Service preventing controller from managing one or many aircraft for receiving ATSU shall not be more than 1,2 1e-6 [sector operating hours].
Status	<in progress>
Rationale	TSSR (integrity/reliability) associated to failure condition derived in order to mitigate the operational hazards defined in the SAR.
Category	<Safety>

[REQ Trace]

Relationship	Linked Element Type	Identifier
<ALLOCATED_TO>	<SESAR Solution>	PJ.10-W2-93A
		PJ.10-W2-93B
		PJ.10-W2-93C

[REQ]

Identifier	REQ-PJ.10-W2.93-TS-SAF017
Title	Integrity / Reliability TSSR loss of service: a/c management for both delegating and receiving ATSU
Requirement	The frequency of occurrence of Loss of Service preventing controller from managing one or many aircraft for both delegating and receiving ATSU shall not be more than 1,2 1e-6 [sector operating hours].
Status	<in progress>
Rationale	TSSR (integrity/reliability) associated to failure condition derived in order to mitigate the operational hazards defined in the SAR.
Category	<Safety>

[REQ Trace]

Relationship	Linked Element Type	Identifier
<ALLOCATED_TO>	<SESAR Solution>	PJ.10-W2-93A
		PJ.10-W2-93B
		PJ.10-W2-93C

[REQ]

Identifier	REQ-PJ.10-W2.93-TS-SAF018
------------	---------------------------

Title	Integrity / Reliability TSSR loss of service: workstation for receiving ATSU
Requirement	The frequency of occurrence of Service Loss (one/two workstation/s) for receiving ATSU” shall be no greater than 2,4 1e-6 [sector operating hours]
Status	<in progress>
Rationale	TSSR (integrity/reliability) associated to failure condition derived in order to mitigate the operational hazards defined in the SAR.
Category	<Safety>

[REQ Trace]

Relationship	Linked Element Type	Identifier
<ALLOCATED_TO>	<SESAR Solution>	PJ.10-W2-93A
		PJ.10-W2-93B
		PJ.10-W2-93C

[REQ]

Identifier	REQ-PJ.10-W2.93-TS-SAF019
Title	Integrity / Reliability TSSR loss of service: workstation for both delegating and receiving ATSU
Requirement	The frequency of occurrence of Service Loss (one/two workstation/s) for both delegating and receiving ATSU” shall be no greater than 2,4 1e-6 [sector operating hours]
Status	<in progress>
Rationale	TSSR (integrity/reliability) associated to failure condition derived in order to mitigate the operational hazards defined in the SAR.
Category	<Safety>

[REQ Trace]

Relationship	Linked Element Type	Identifier
<ALLOCATED_TO>	<SESAR Solution>	PJ.10-W2-93A
		PJ.10-W2-93B
		PJ.10-W2-93C

[REQ]

Identifier	REQ-PJ.10-W2.93-TS-SAF020
Title	Integrity / Reliability TSSR loss of service: Corruption for receiving ATSU
Requirement	The frequency of occurrence of Loss of Service resulting in “Detected corruption for receiving ATSU” preventing the controller to have access to all functionality required to safely manage traffic shall be no greater than 6,0 1e-7 [sector operating hours]
Status	<in progress>
Rationale	TSSR (integrity/reliability) associated to failure condition derived in order to mitigate the operational hazards defined in the SAR.
Category	<Safety>

[REQ Trace]

Relationship	Linked Element Type	Identifier
<ALLOCATED_TO>	<SESAR Solution>	PJ.10-W2-93A
		PJ.10-W2-93B
		PJ.10-W2-93C

[REQ]

Identifier	REQ-PJ.10-W2.93-TS-SAF021
Title	Integrity / Reliability TSSR loss of service: Corruption for both delegating and receiving ATSU
Requirement	The frequency of occurrence of Loss of Service resulting in “Detected corruption for both delegating and receiving ATSU” preventing the controller to have access to all functionality required to safely manage traffic shall be no greater than 6,0 1e-7 [sector operating hours]
Status	<in progress>
Rationale	TSSR (integrity/reliability) associated to failure condition derived in order to mitigate the operational hazards defined in the SAR.
Category	<Safety>

[REQ Trace]

Relationship	Linked Element Type	Identifier
<ALLOCATED_TO>	<SESAR Solution>	PJ.10-W2-93A
		PJ.10-W2-93B

		PJ.10-W2-93C
--	--	--------------

[REQ]

Identifier	REQ-PJ.10-W2.93-TS-SAF022
Title	Integrity / Reliability TSSR loss of service: Undetected Corruption for receiving ATSU
Requirement	The frequency of occurrence of Loss of Service resulting in “Undetected corruption for receiving ATSU” preventing the controller to have access to all functionality required to safely manage traffic shall be no greater than 1,2 1e-7 [sector operating hours]
Status	<in progress>
Rationale	TSSR (integrity/reliability) associated to failure condition derived in order to mitigate the operational hazards defined in the SAR.
Category	<Safety>

[REQ Trace]

Relationship	Linked Element Type	Identifier
<ALLOCATED_TO>	<SESAR Solution>	PJ.10-W2-93A
		PJ.10-W2-93B
		PJ.10-W2-93C

[REQ]

Identifier	REQ-PJ.10-W2.93-TS-SAF023
Title	Integrity / Reliability TSSR loss of service: Undetected Corruption for both delegating and receiving ATSU
Requirement	The frequency of occurrence of Loss of Service resulting in “Undetected corruption for both delegating and receiving ATSU” preventing the controller to have access to all functionality required to safely manage traffic shall be no greater than 1,2 1e-7 [sector operating hours]
Status	<in progress>
Rationale	TSSR (integrity/reliability) associated to failure condition derived in order to mitigate the operational hazards defined in the SAR.
Category	<Safety>

[REQ Trace]

Relationship	Linked Element Type	Identifier
<ALLOCATED_TO>	<SESAR Solution>	PJ.10-W2-93A
		PJ.10-W2-93B
		PJ.10-W2-93C

[REQ]

Identifier	REQ-PJ.10-W2.93-TS-SAF024
Title	Automatic activation of Rx frequency during preview mode
Requirement	The frequency of the delegated sector should be activated automatically to Rx at the Executive CWP of the receiving ATSU when the receiving ATSU activates the preview mode for this sector.
Status	<in progress>
Rationale	Automatically activating a sector frequency relieves the Executive ATCO of the receiving ATSU and prevents that the frequency remains inactive by mistake. But it requires an integration of the ATS system and the VCS.
Category	<Safety>

[REQ Trace]

Relationship	Linked Element Type	Identifier
<ALLOCATED_TO>	<SESAR Solution>	PJ.10-W2-93A
		PJ.10-W2-93B
		PJ.10-W2-93C
<ALLOCATED_TO>	<Enabler>	ER APP ATC 194_Management in the ADSP of a CWP preview mode during delegation of ATS Provision between ATSUs
		ER APP ATC 193_Management in the VC ATSU of a CWP preview mode during delegation of ATS Provision between ATSUs

[REQ]

Identifier	REQ-PJ.10-W2.93-TS-SAF025
Title	Automatic activation of Rx frequency while switching to preview mode at delegating ATSU

Requirement	The frequency of the delegated sector should be switched automatically from Tx/Rx to Rx at the Executive CWP of the delegating ATSU when switching from operational mode to preview mode in the delegating ATSU.
Status	<in progress>
Rationale	Automatically switching a sector frequency to Rx relieves the Executive ATCO of the delegating ATSU and prevents that the frequency remains in Tx/Rx by mistake. But it requires an integration of the ATS system and the VCS.
Category	<Safety>

[REQ Trace]

Relationship	Linked Element Type	Identifier
<ALLOCATED_TO>	<SESAR Solution>	PJ.10-W2-93A
		PJ.10-W2-93B
		PJ.10-W2-93C
<ALLOCATED_TO>	<Enabler>	ER APP ATC 194_Management in the ADSP of a CWP preview mode during delegation of ATS Provision between ATSUs
		ER APP ATC 193_Management in the VC ATSU of a CWP preview mode during delegation of ATS Provision between ATSUs

[REQ]

Identifier	REQ-PJ.10-W2.93-TS-SAF026
Title	Automatic activation of Tx/Rx frequency during operational mode
Requirement	The frequency of the delegated sector should be switched automatically from Rx to Tx/Rx at the Executive CWP of the receiving ATSU when switching from preview mode to operational mode for this sector in the receiving ATSU.
Status	<in progress>
Rationale	Automatically switching a sector frequency to Tx/Rx relieves the Executive ATCO of the receiving ATSU and prevents that the frequency remains on Rx by mistake. But it requires an integration of the ATS system and the VCS.
Category	<Safety>

[REQ Trace]

Relationship	Linked Element Type	Identifier
<ALLOCATED_TO>	<SESAR Solution>	PJ.10-W2-93A PJ.10-W2-93B PJ.10-W2-93C
<ALLOCATED_TO>	<Enabler>	ER APP ATC 194_Management in the ADSP of a CWP preview mode during delegation of ATS Provision between ATSUs ER APP ATC 193_Management in the VC ATSU of a CWP preview mode during delegation of ATS Provision between ATSUs

[REQ]

Identifier	REQ-PJ.10-W2.93-TS-SAF027
Title	Automatic disabling of frequency after termination of preview mode
Requirement	The frequency of the delegated sector should automatically be disabled when the preview mode is terminated at the delegating ATSU.
Status	<in progress>
Rationale	Automatic disabling of a sector frequency relieves the Executive ATCO of the delegating ATSU and prevents that the frequency remains active by mistake. But it requires an integration of the ATS system and the VCS.
Category	<Safety>

[REQ Trace]

Relationship	Linked Element Type	Identifier
<ALLOCATED_TO>	<SESAR Solution>	PJ.10-W2-93A PJ.10-W2-93B PJ.10-W2-93C
<ALLOCATED_TO>	<Enabler>	ER APP ATC 194_Management in the ADSP of a CWP preview mode during delegation of ATS Provision between ATSUs ER APP ATC 193_Management in the VC ATSU of a CWP preview mode during delegation of ATS Provision between ATSUs

[REQ]

Identifier	REQ-PJ.10-W2.93-TS-SAF028
Title	System input to abort delegation
Requirement	The operational Supervisor and/or the ATSEP shall be able to make the system input to abort a delegation.
Status	<in progress>
Rationale	In order to abort the delegation, the human actor (Supervisor or ATSEP) needs support from the system and must be able to make the required system inputs.
Category	<Safety>

[REQ Trace]

Relationship	Linked Element Type	Identifier
<ALLOCATED_TO>	<SESAR Solution>	PJ.10-W2-93A
		PJ.10-W2-93B
		PJ.10-W2-93C
<ALLOCATED_TO>	<Enabler>	SVC-049_Operational Configuration Distribution of Working Position Preview Mode, and Neighbouring ATSU Sector configuration for ATM Service Delegation
		SVC-050_Operational Configuration Management of Working Position Preview Mode, and Neighbouring ATSU Sectors for ATM Service Delegation

[REQ]

Identifier	REQ-PJ.10-W2.93-TS-SAF029
Title	Recurrent Training Need
Requirement	Recurrent Training shall be provided to VC technical staff in order to guarantee an optimal maintenance of competence.
Status	<in progress>
Rationale	SAF and HP requirement related to the necessity of reinforcing and broadening the knowledge and skills that is necessary for performing effectively the VC technical staff role.
Category	<Safety>

[REQ Trace]

Relationship	Linked Element Type	Identifier
<ALLOCATED_TO>	<SESAR Solution>	PJ.10-W2-93A

		PJ.10-W2-93B
		PJ.10-W2-93C

[REQ]

Identifier	REQ-PJ.10-W2.93-TS-SAF030
Title	Synchronization between ATC ADSP and Voice ADSP
Requirement	Synchronization between ATC ADSP and Voice ADSP supporting both receiving and delegating ATSUs shall be provided. This could be e.g. synchronization of frequency table data, etc.
Status	<in progress>
Rationale	Continuous synchronization between ATC ADSP and Voice ADSP is required in order to share configuration data and other to ensure full service ability.
Category	<Safety>

[REQ Trace]

Relationship	Linked Element Type	Identifier
<ALLOCATED_TO>	<SESAR Solution>	PJ.10-W2-93A
<ALLOCATED_TO>	<Enabler>	ER APP ATC 184_ATM Data Service Provider for ATC services in a Virtual Centre context
<ALLOCATED_TO>	<System>	ADSP ATC (PJ.10-93)

[REQ]

Identifier	REQ-PJ.10-W2.93-TS-SAF031
Title	Coordination and synchronization messages between ATC and/or Voice ADSPs
Requirement	In case of contingency, coordination and synchronization messages shall be exchanged between ATC and/or Voice ADSPs.
Status	<in progress>
Rationale	For contingency purpose, coordination and synchronization messages might need to be exchanged, depending on the contingency policy in place between two or more ATC and/or Voice ADSP.
Category	<Safety>

[REQ Trace]

Relationship	Linked Element Type	Identifier
<ALLOCATED_TO>	<SESAR Solution>	PJ.10-W2-93B PJ.10-W2-93C
<ALLOCATED_TO>	<Enabler>	ER APP ATC 185_ATM Data Service Provider for Voice services in a Virtual Centre context ER APP ATC 186_Virtual Centre ATSU
<ALLOCATED_TO>	<System>	ADSP Voice (PJ.10-93)

[REQ]

Identifier	REQ-PJ.10-W2.93-TS-SAF032
Title	VCCI ensuring no corrupted data provided
Requirement	The VCCI shall ensure that no corrupted data is provided to any communicating client.
Status	<in progress>
Rationale	Requirement extracted from PJ.16-03 (REQ.SPR.PHYS.0110). The communication infrastructure shall protect its client from receiving corrupted data. Requirement to mitigate OH05 as defined in the SAR.
Category	<Safety>

[REQ Trace]

Relationship	Linked Element Type	Identifier
<ALLOCATED_TO>	<SESAR Solution>	PJ.10-W2-93A PJ.10-W2-93B PJ.10-W2-93C

[REQ]

Identifier	REQ-PJ.10-W2.93-TS-SAF033
Title	Contract with data providers
Requirement	The contract with the data providers shall ensure appropriate service availability, integrity, performance, security, etc
Status	<in progress>

Rationale	Requirement extracted from PJ.16-03 (REQ.SPR.PHYS.0120). A contract shall be in place and set appropriate requirements for availability, integrity, performance, security, etc. Requirement to mitigate OH05 as defined in the SAR.
Category	<Safety>

[REQ Trace]

Relationship	Linked Element Type	Identifier
<ALLOCATED_TO>	<SESAR Solution>	PJ.10-W2-93A
		PJ.10-W2-93B
		PJ.10-W2-93C

[REQ]

Identifier	REQ-PJ.10-W2.93-TS-SAF034
Title	KPI to ensure hazard safety requirements are met
Requirement	The communication service shall meet appropriate targets (KPIs) with regard to site availability, service interruption per site, network response time, packet delivery ratio, etc. to ensure that (related) hazard safety requirements are met and the probability of their occurrence is reduced as far as practicable.
Status	<in progress>
Rationale	Requirement extracted from PJ.16-03 (REQ.SPR.PHYS.0150). The overall network failure shall be addressed by requirements of the robustness of the network operations. The robustness shall be described through KPIs for key service areas to ensure communication service at all times.
Category	<Safety>

[REQ Trace]

Relationship	Linked Element Type	Identifier
<ALLOCATED_TO>	<SESAR Solution>	PJ.10-W2-93A
		PJ.10-W2-93B
		PJ.10-W2-93C

[REQ]

Identifier	REQ-PJ.10-W2.93-TS-SAF035
Title	Consisting of business messages that are tamper proof
Requirement	The AMQP or equivalent message framework should provide a framework which will ensure a tamper proof message exchange between clients and servers.
Status	<in progress>
Rationale	Requirement extracted from PJ.16-03 (REQ-16.03-SAF-VCCI.0003).
Category	<Safety>

[REQ Trace]

Relationship	Linked Element Type	Identifier
<ALLOCATED_TO>	<SESAR Solution>	PJ.10-W2-93A
		PJ.10-W2-93B

[REQ]

Identifier	REQ-PJ.10-W2.93-TS-SAF036
Title	Message delivery is resilient to technical failure
Requirement	The AMQP or equivalent message framework shall be resilient towards technical failure of the underlying communication infrastructure, so that no transaction based messages, i.e. requests are lost.
Status	<in progress>
Rationale	Requirement extracted from PJ.16-03 (REQ-16.03-SAF-VCCI.0005). The delivery of messages shall be robust towards technical failures. No transaction based messages, i.e. requests can thus be accepted to become lost due to temporary outage of the communication network
Category	<Safety>

[REQ Trace]

Relationship	Linked Element Type	Identifier
<ALLOCATED_TO>	<SESAR Solution>	PJ.10-W2-93A
		PJ.10-W2-93B

[REQ]

Identifier	REQ-PJ.10-W2.93-TS-SAF037
Title	Sender and Receiver are mutually agreed upon counter parties
Requirement	The AMQP or equivalent message framework shall ensure that the Sender and Receiver are mutually agreed upon counter parties - No possibility for injection of Spam should be available.
Status	<in progress>
Rationale	Requirement extracted from PJ.16-03 (REQ-16.03-SAF-VCCI.0006). In order to protect against connection and communication with a false or unwanted client (i.e. man-in-the-middle) the connection between Sender and Receiver shall be mutually agreed.
Category	<Safety>

[REQ Trace]

Relationship	Linked Element Type	Identifier
<ALLOCATED_TO>	<SESAR Solution>	PJ.10-W2-93A
		PJ.10-W2-93B

[REQ]

Identifier	REQ-PJ.10-W2.93-TS-SAF038
Title	Redundant equipment for critical servers
Requirement	All critical equipment shall have redundant configurations to ensure switch-over in case of failure
Status	<in progress>
Rationale	Requirement extracted from PJ.16-03 (REQ-16.03-SAF-EQP.0001). To ensure a continued operation all critical servers shall be designed with a redundant architecture.
Category	<Safety>

[REQ Trace]

Relationship	Linked Element Type	Identifier
<ALLOCATED_TO>	<SESAR Solution>	PJ.10-W2-93A
		PJ.10-W2-93B
		PJ.10-W2-93C

4.2.2.3 Security Requirements

This section summarises the security requirements as they have been derived from the application of the SecRAM 2.0 Methodology. Each requirement is associated to one supporting asset and derived from the control, or the controls applied to that supporting asset to reduce the risk on the associated primary asset.

It shall be noted that, being part of an ATM infrastructure, all the relevant regulation applies to the developments of the systems and operations. The NIS directive is the high-level regulatory framework which shall be applied. This implies the adherence to a Security Management System for all the involved stakeholders (ATM system developers, ANSP, ...). At this objectives, one reference (or both) ISO27001 and NIST CSF (Cyber Security Framework) could be applied, noting that the SecRAM controls directly derive from the ISO 27001 framework. Other standards could be applied if equivalent and traceable with the previous one (e.g.: the UK regulation by CAA based on the CAF - CAP 1753).

It is worth reporting that EASA is currently working on a standard (called Part-IS), which is being introduced into European law and may become a regulation for European aviation organisations. Longer term ICAO are developing some global information security performance requirements with an Information Security Manual (ISM). Again, these requirements can be traced to the industry standards mentioned but the intent is to have an aviation specific set of requirements that could be applied globally (i.e. across 193 states). ISM came about to address greater digital interoperability between aviation organisations globally.

Because of the previous statement, there should be considered as an assumption a set of security requirements derived from the mentioned standards (e.g. restricted access and authorisation on administrative systems, including access to the virtualization management if used).

[REQ]

Identifier	REQ-PJ10-W2-93-TS-SEC.029
Title	Security Standard and Framework
Requirement	All entities involved in the VC service development and provision shall adopt process and procedures aligned with the existing security frameworks (i.e. ISO 27001, NIST CSF).
Status	<in progress>
Rationale	Almost without exception, organisations worldwide and across sectors will reference either or both ISO27001 and NIST CSF (Cyber Security Framework), which is to say these requirements have a foundation with these standards – most who have a cyber security role will be familiar with these standards.
Category	<Security>

[REQ Trace]

Relationship	Linked Element Type	Identifier

<ALLOCATED_TO>	<SESAR Solution>	PJ.10-W2-93A PJ.10-W2-93B PJ.10-W2-93C
<ALLOCATED_TO>	<Enabler>	ER APP ATC 184_ATM Data Service Provider for ATC services in a Virtual Centre context ER APP ATC 185_ATM Data Service Provider for Voice services in a Virtual Centre context ER APP ATC 186_Virtual Centre ATSU
<ALLOCATED_TO>	<System>	Communication Infrastructure (PJ.10-93)

[REQ]

Identifier	REQ-PJ10-W2-93-TS-SEC.001
Title	Authentication on Communication Infrastructure
Requirement	Each entity connected to the Communication Infrastructure—the requestor and the provider—shall be authenticated.
Status	<in progress>
Rationale	Authentication may be implemented accepting credential (or a certificate) from the entity and validating it against an authority (e.g. using a certified PKI) Derived from SecRAM 2.0 Security Risk Assessment Methodology.
Category	<Security>

[REQ Trace]

Relationship	Linked Element Type	Identifier
<ALLOCATED_TO>	<SESAR Solution>	PJ.10-W2-93A PJ.10-W2-93B
<ALLOCATED_TO>	<Enabler>	ER APP ATC 184_ATM Data Service Provider for ATC services in a Virtual Centre context ER APP ATC 185_ATM Data Service Provider for Voice services in a Virtual Centre context

[REQ]

Identifier	REQ-PJ10-W2-93-TS-SEC.002
Title	Network Management on Communication Infrastructure
Requirement	The Communication Infrastructure shall be protected by a real time Network Monitoring System (e.g.: IDPS).
Status	<in progress>
Rationale	Derived from SecRAM 2.0 Security Risk Assessment Methodology
Category	<Security>

[REQ Trace]

Relationship	Linked Element Type	Identifier
<ALLOCATED_TO>	<SESAR Solution>	PJ.10-W2-93A
		PJ.10-W2-93B
<ALLOCATED_TO>	<Enabler>	ER APP ATC 184_ATM Data Service Provider for ATC services in a Virtual Centre context
		ER APP ATC 185_ATM Data Service Provider for Voice services in a Virtual Centre context
<ALLOCATED_TO>	<System>	Communication Infrastructure (PJ.10-93)

[REQ]

Identifier	REQ-PJ10-W2-93-TS-SEC.003
Title	Redundancy of Communication Infrastructure architecture
Requirement	The Communication Infrastructure shall be designed with a redundant architecture.
Status	<in progress>
Rationale	Derived from SecRAM 2.0 Security risk Assessment Methodology.
Category	<Security>

[REQ Trace]

Relationship	Linked Element Type	Identifier
<ALLOCATED_TO>	<SESAR Solution>	PJ.10-W2-93A
		PJ.10-W2-93B

<ALLOCATED_TO>	<Enabler>	ER APP ATC 185_ATM Data Service Provider for Voice services in a Virtual Centre context ER APP ATC 184_ATM Data Service Provider for ATC services in a Virtual Centre context
<ALLOCATED_TO>	<System>	Communication Infrastructure (PJ.10-93)

[REQ]

Identifier	REQ-PJ10-W2-93-TS-SEC.004
Title	Hardening of Communication Infrastructure architecture
Requirement	Communication Infrastructure shall be securely configured (e.g. reduce attack surface, use secure protocols, apply patching, etc).
Status	<in progress>
Rationale	Derived from SecRAM 2.0 Security risk Assessment Methodology.
Category	<Security>

[REQ Trace]

Relationship	Linked Element Type	Identifier
<ALLOCATED_TO>	<SESAR Solution>	PJ.10-W2-93A PJ.10-W2-93B
<ALLOCATED_TO>	<Enabler>	ER APP ATC 185_ATM Data Service Provider for Voice services in a Virtual Centre context ER APP ATC 184_ATM Data Service Provider for ATC services in a Virtual Centre context
<ALLOCATED_TO>	<System>	Communication Infrastructure (PJ.10-93)

[REQ]

Identifier	REQ-PJ10-W2-93-TS-SEC.005
Title	Authentication on Voice ADSP
Requirement	Each entity connected to the Voice Communication ADSP —the requestor and the provider—shall be authenticated.
Status	<in progress>
Rationale	Derived from SecRAM 2.0 Security risk Assessment Methodology.
Category	<Security>

[REQ Trace]

Relationship	Linked Element Type	Identifier
<ALLOCATED_TO>	<SESAR Solution>	PJ.10-W2-93A PJ.10-W2-93B
<ALLOCATED_TO>	<Enabler>	ER APP ATC 185_ATM Data Service Provider for Voice services in a Virtual Centre context ER APP ATC 186_Virtual Centre ATSU
<ALLOCATED_TO>	<System>	ADSP Voice (PJ.10-93)

[REQ]

Identifier	REQ-PJ10-W2-93-TS-SEC.006
Title	Authorization for Voice ADSP
Requirement	Voice ADSP shall have user authentication.
Status	<in progress>
Rationale	Derived from SecRAM 2.0 Security risk Assessment Methodology.
Category	<Security>

[REQ Trace]

Relationship	Linked Element Type	Identifier
<ALLOCATED_TO>	<SESAR Solution>	PJ.10-W2-93A PJ.10-W2-93B
<ALLOCATED_TO>	<Enabler>	ER APP ATC 185_ATM Data Service Provider for Voice services in a Virtual Centre context
<ALLOCATED_TO>	<System>	ADSP Voice (PJ.10-93)

[REQ]

Identifier	REQ-PJ10-W2-93-TS-SEC.007
Title	Hardening of Voice ADSP architecture

Requirement	Voice ADSP servers shall be securely configured (e.g. reduce attack surface, use secure protocols, apply patching, etc) and derived from ISO 27001 framework.
Status	<in progress>
Rationale	Example of secure protocol is IPSec for the network level. Derived from SecRAM 2.0 Security risk Assessment Methodology.
Category	<Security>

[REQ Trace]

Relationship	Linked Element Type	Identifier
<ALLOCATED_TO>	<SESAR Solution>	PJ.10-W2-93A
		PJ.10-W2-93B
<ALLOCATED_TO>	<Enabler>	ER APP ATC 185_ATM Data Service Provider for Voice services in a Virtual Centre context
<ALLOCATED_TO>	<System>	ADSP Voice (PJ.10-93)

[REQ]

Identifier	REQ-PJ10-W2-93-TS-SEC.008
Title	Redundancy of Voice ADSP architecture
Requirement	Voice ADSP shall be provided through redundant systems or architecture
Status	<in progress>
Rationale	Derived from SecRAM 2.0 Security risk Assessment Methodology.
Category	<Security>

[REQ Trace]

Relationship	Linked Element Type	Identifier
<ALLOCATED_TO>	<SESAR Solution>	PJ.10-W2-93A
		PJ.10-W2-93B

<ALLOCATED_TO>	<Enabler>	ER APP ATC 185_ATM Data Service Provider for Voice services in a Virtual Centre context
<ALLOCATED_TO>	<System>	ADSP Voice (PJ.10-93)

[REQ]

Identifier	REQ-PJ10-W2-93-TS-SEC.009
Title	Network management on Voice ADSP
Requirement	The Voice ADSP network shall be protected by a real time network monitoring system (e.g. IDPS).
Status	<in progress>
Rationale	Derived from SecRAM 2.0 Security risk Assessment Methodology.
Category	<Security>

[REQ Trace]

Relationship	Linked Element Type	Identifier
<ALLOCATED_TO>	<SESAR Solution>	PJ.10-W2-93A PJ.10-W2-93B
<ALLOCATED_TO>	<Enabler>	ER APP ATC 185_ATM Data Service Provider for Voice services in a Virtual Centre context
<ALLOCATED_TO>	<System>	ADSP Voice (PJ.10-93)

[REQ]

Identifier	REQ-PJ10-W2-93-TS-SEC.012
Title	Time synchronization
Requirement	All architectural components of the VC infrastructure shall be synchronized to a trusted authoritative time server.
Status	<in progress>
Rationale	Derived from SecRAM 2.0 Security risk Assessment Methodology.
Category	<Security>

[REQ Trace]

Relationship	Linked Element Type	Identifier
<ALLOCATED_TO>	<SESAR Solution>	PJ.10-W2-93A PJ.10-W2-93B PJ.10-W2-93C
<ALLOCATED_TO>	<Enabler>	ER APP ATC 185_ATM Data Service Provider for Voice services in a Virtual Centre context
<ALLOCATED_TO>	<System>	ADSP Voice (PJ.10-93)

[REQ]

Identifier	REQ-PJ10-W2-93-TS-SEC.013
Title	Authentication on ATC ADSP
Requirement	The ATSU shall be authenticated to connect to the ATC ADSP and agree on an information sharing scheme.
Status	<in progress>
Rationale	<p>Authentication may be implemented accepting credential (or a certificate) from the entity and validating it against an authority (e.g. using a certified PKI).</p> <p>Derived from SecRAM 2.0 Security risk Assessment Methodology.</p> <p>The risk can be reduced by agreeing in principle not to use information or create information that would be subject to such concerns and restrictions. The focus would be on developing strategy (principles, policies and standards), consuming and referencing publicly available information (e.g. standards from ISO, NIST etc.) to do this. If information consumed or produced is, or needs to be classified, the risk of unauthorised access can be reduced by using an agreed information sharing scheme such as the TLP (Traffic Light Protocol), which is widely used – the obligation for handling information classified using such a protocol would remain the obligation of the participating organisations but it would be expected that they agree up front to be bound by such obligations.</p>
Category	<Security>

[REQ Trace]

Relationship	Linked Element Type	Identifier
<ALLOCATED_TO>	<SESAR Solution>	PJ.10-W2-93A

		PJ.10-W2-93B
<ALLOCATED_TO>	<Enabler>	ER APP ATC 184_ATM Data Service Provider for ATC services in a Virtual Centre context
<ALLOCATED_TO>	<System>	ADSP ATC (PJ.10-93)

[REQ]

Identifier	REQ-PJ10-W2-93-TS-SEC.014
Title	Authorization for ATC ADSP
Requirement	ATC ADSP shall have users' authorization.
Status	<in progress>
Rationale	Derived from SecRAM 2.0 Security risk Assessment Methodology.
Category	<Security>

[REQ Trace]

Relationship	Linked Element Type	Identifier
<ALLOCATED_TO>	<SESAR Solution>	PJ.10-W2-93A PJ.10-W2-93B
<ALLOCATED_TO>	<Enabler>	ER APP ATC 184_ATM Data Service Provider for ATC services in a Virtual Centre context
<ALLOCATED_TO>	<System>	ADSP ATC (PJ.10-93)

[REQ]

Identifier	REQ-PJ10-W2-93-TS-SEC.018
Title	Environmental & Physical Security of ATC ADSP
Requirement	ATC ADSP access shall be secured physically.
Status	<in progress>
Rationale	Derived from SecRAM 2.0 Security risk Assessment Methodology.
Category	<Security>

[REQ Trace]

Relationship	Linked Element Type	Identifier
<ALLOCATED_TO>	<SESAR Solution>	PJ.10-W2-93A PJ.10-W2-93B
<ALLOCATED_TO>	<Enabler>	ER APP ATC 184_ATM Data Service Provider for ATC services in a Virtual Centre context
<ALLOCATED_TO>	<System>	ADSP ATC (PJ.10-93)

[REQ]

Identifier	REQ-PJ10-W2-93-TS-SEC.019
Title	Authentication on VC ATSU
Requirement	Each entity connected to the VC HMI—the requestor and the provider—shall be authenticated.
Status	<in progress>
Rationale	Authentication may be implemented accepting credential (or a certificate) from the entity and validating it against an authority (e.g. using a certified PKI). Derived from SecRAM 2.0 Security risk Assessment Methodology.
Category	<Security>

[REQ Trace]

Relationship	Linked Element Type	Identifier
<ALLOCATED_TO>	<SESAR Solution>	PJ.10-W2-93A PJ.10-W2-93B
<ALLOCATED_TO>	<Enabler>	ER APP ATC 186_Virtual Centre ATSU
<ALLOCATED_TO>	<System>	VC ATSU ATC (PJ.10-93)

[REQ]

Identifier	REQ-PJ10-W2-93-TS-SEC.020
Title	Authorization for VC ATSU
Requirement	VC ATSU shall have users' authorization.

Status	<in progress>
Rationale	Derived from SecRAM 2.0 Security risk Assessment Methodology.
Category	<Security>

[REQ Trace]

Relationship	Linked Element Type	Identifier
<ALLOCATED_TO>	<SESAR Solution>	PJ.10-W2-93A
		PJ.10-W2-93B
<ALLOCATED_TO>	<Enabler>	ER APP ATC 186_Virtual Centre ATSU
<ALLOCATED_TO>	<System>	VC ATSU ATC (PJ.10-93)

[REQ]

Identifier	REQ-PJ10-W2-93-TS-SEC.024
Title	Environmental & Physical Security of VC ATSU
Requirement	VC ATSU access shall be secured physically.
Status	<in progress>
Rationale	Derived from SecRAM 2.0 Security risk Assessment Methodology.
Category	<Security>

[REQ Trace]

Relationship	Linked Element Type	Identifier
<ALLOCATED_TO>	<SESAR Solution>	PJ.10-W2-93A
		PJ.10-W2-93B
<ALLOCATED_TO>	<Enabler>	ER APP ATC 186_Virtual Centre ATSU
<ALLOCATED_TO>	<System>	VC ATSU ATC (PJ.10-93)

[REQ]

Identifier	REQ-PJ10-W2-93-TS-SEC.025
------------	---------------------------

Title	Environmental & Physical Security of Surveillance infrastructure en route
Requirement	Surveillance infrastructure access shall be secured physically.
Status	<in progress>
Rationale	Derived from SecRAM 2.0 Security risk Assessment Methodology.
Category	<Security>

[REQ Trace]

Relationship	Linked Element Type	Identifier
<ALLOCATED_TO>	<SESAR Solution>	PJ.10-W2-93A PJ.10-W2-93B

[REQ]

Identifier	REQ-PJ10-W2-93-TS-SEC.026
Title	Authentication on OLDI (AFTN connection)
Requirement	Each entity connected to the AFTN network shall be authenticated.
Status	<in progress>
Rationale	Derived from SecRAM 2.0 Security risk Assessment Methodology.
Category	<Security>

[REQ Trace]

Relationship	Linked Element Type	Identifier
<ALLOCATED_TO>	<SESAR Solution>	PJ.10-W2-93C
<ALLOCATED_TO>	<System>	ADSP ATC (PJ.10-93)

[REQ]

Identifier	REQ-PJ10-W2-93-TS-SEC.028
Title	Redundancy of ATC ADSP
Requirement	ATC ADSP shall be provided through redundant systems or architecture.

Status	<in progress>
Rationale	Derived from SecRAM 2.0 Security risk Assessment Methodology.
Category	<Security>

[REQ Trace]

Relationship	Linked Element Type	Identifier
<ALLOCATED_TO>	<SESAR Solution>	PJ.10-W2-93A
<ALLOCATED_TO>	<Enabler>	ER APP ATC 184_ATM Data Service Provider for ATC services in a Virtual Centre context
<ALLOCATED_TO>	<System>	ADSP ATC (PJ.10-93)

4.2.2.4 Reliability Requirements

[REQ]

Identifier	REQ-16-03-NFR-REL.0001
Title	Business Resilience - Very Major Impact
Requirement	A failure within the ADSP technical platform resulting in a Very Major impact shall occur less than once every 10 years.
Status	<in progress>
Rationale	A very major Impact is defined as loss resulting in >100,000 minutes ATSU/ADSP attributable flight delay. This requirement needs to be placed on the technical platform.
Category	<Reliability>

[REQ Trace]

Relationship	Linked Element Type	Identifier
<ALLOCATED_TO>	<SESAR Solution>	PJ.10-W2-93A PJ.10-W2-93B PJ.10-W2-93C
<ALLOCATED_TO>	<Enabler>	ER APP ATC 184_ATM Data Service Provider for ATC services in a Virtual Centre context

		ER APP ATC 185_ATM Data Service Provider for Voice services in a Virtual Centre context
<ALLOCATED_TO>	<System>	ADSP ATC (PJ.10-93) ADSP Voice (PJ.10-93)

[REQ]

Identifier	REQ-16-03-NFR-REL.0002
Title	Business Resilience – Major Impact
Requirement	A failure within the ADSP technical platform resulting in a Major impact shall occur less than once every 5 years.
Status	<in progress>
Rationale	A major Impact is defined as loss resulting in >20,000 and <100,000 minutes of ATSU/ADSP attributable flight delay. This requirement needs to be placed on the technical platform.
Category	<Reliability>

[REQ Trace]

Relationship	Linked Element Type	Identifier
<ALLOCATED_TO>	<SESAR Solution>	PJ.10-W2-93A PJ.10-W2-93B PJ.10-W2-93C
<ALLOCATED_TO>	<Enabler>	ER APP ATC 184_ATM Data Service Provider for ATC services in a Virtual Centre context ER APP ATC 185_ATM Data Service Provider for Voice services in a Virtual Centre context
<ALLOCATED_TO>	<System>	ADSP ATC (PJ.10-93) ADSP Voice (PJ.10-93)

[REQ]

Identifier	REQ-16-03-NFR-REL.0003
Title	Business Resilience – Moderate Impact
Requirement	A failure within the ADSP technical platform resulting in a Moderate impact shall occur less than once every 2-3 years.
Status	<in progress>

Rationale	A moderate Impact is defined as loss resulting >10,000 and <20,000 minutes of ATSU/ADSP attributable flight delay. This requirement needs to be placed on the technical platform.
Category	<Reliability>

[REQ Trace]

Relationship	Linked Element Type	Identifier
<ALLOCATED_TO>	<SESAR Solution>	PJ.10-W2-93A PJ.10-W2-93B PJ.10-W2-93C
<ALLOCATED_TO>	<Enabler>	ER APP ATC 184_ATM Data Service Provider for ATC services in a Virtual Centre context ER APP ATC 185_ATM Data Service Provider for Voice services in a Virtual Centre context
<ALLOCATED_TO>	<System>	ADSP ATC (PJ.10-93) ADSP Voice (PJ.10-93)

[REQ]

Identifier	REQ-16-03-NFR-REL.0004
Title	Business Resilience – Notable Impact
Requirement	A failure within the ADSP technical platform resulting in a Notable impact shall occur less than once every 2-3 months.
Status	<in progress>
Rationale	A notable Impact is defined as loss resulting >4,000 and <10,000 minutes of ATSU/ADSP attributable flight delay. This requirement needs to be placed on the technical platform.
Category	<Reliability>

[REQ Trace]

Relationship	Linked Element Type	Identifier
<ALLOCATED_TO>	<SESAR Solution>	PJ.10-W2-93A PJ.10-W2-93B PJ.10-W2-93C
<ALLOCATED_TO>	<Enabler>	ER APP ATC 184_ATM Data Service Provider for ATC services in a Virtual Centre context

		ER APP ATC 185_ATM Data Service Provider for Voice services in a Virtual Centre context
<ALLOCATED_TO>	<System>	ADSP ATC (PJ.10-93) ADSP Voice (PJ.10-93)

[REQ]

Identifier	REQ-16-03-NFR-REL.0005
Title	Business Resilience – Minor Impact
Requirement	A failure within the ADSP technical platform resulting in a Minor impact shall occur less than once every 1-2 months.
Status	<in progress>
Rationale	A minor Impact is defined as loss resulting <4,000 minutes of ATSU/ADSP attributable flight delay. This requirement needs to be placed on the technical platform.
Category	<Reliability>

[REQ Trace]

Relationship	Linked Element Type	Identifier
<ALLOCATED_TO>	<SESAR Solution>	PJ.10-W2-93A PJ.10-W2-93B PJ.10-W2-93C
<ALLOCATED_TO>	<Enabler>	ER APP ATC 184_ATM Data Service Provider for ATC services in a Virtual Centre context ER APP ATC 185_ATM Data Service Provider for Voice services in a Virtual Centre context
<ALLOCATED_TO>	<System>	ADSP ATC (PJ.10-93) ADSP Voice (PJ.10-93)

4.2.2.5 Data Requirements

[REQ]

Identifier	REQ-16-03-NFR-DAT.0001
Title	Data Reporting – recording of raw/original data
Requirement	All data shall be stored in its rawest/ original form and transformed to make it usable.
Status	<in progress>

Rationale	All data needs to be recorded in its original form to enable detection of corruption and errors in data translation and transformation. In addition, recorded data need to be transformed to make it usable by other systems and human readable.
Category	<Data>

[REQ Trace]

Relationship	Linked Element Type	Identifier
<ALLOCATED_TO>	<SESAR Solution>	PJ.10-W2-93A PJ.10-W2-93B PJ.10-W2-93C
<ALLOCATED_TO>	<Enabler>	ER APP ATC 184_ATM Data Service Provider for ATC services in a Virtual Centre context ER APP ATC 185_ATM Data Service Provider for Voice services in a Virtual Centre context
<ALLOCATED_TO>	<System>	ADSP ATC (PJ.10-93) ADSP Voice (PJ.10-93)

[REQ]

Identifier	REQ-16-03-NFR-DAT.0002
Title	Data Reporting – recording of service, management and legal data
Requirement	All services shall store a copy of all service data, service management data and legal data in a Data Storage Repository in its rawest/ original format.
Status	<in progress>
Rationale	Service data, service management data, security event data and legal data in a data repository, typically external to the service, to meet data retention requirements, service restoration requirements, investigation and legal requirements.
Category	<Data>

[REQ Trace]

Relationship	Linked Element Type	Identifier
<ALLOCATED_TO>	<SESAR Solution>	PJ.10-W2-93A

		PJ.10-W2-93B PJ.10-W2-93C
<ALLOCATED_TO>	<Enabler>	ER APP ATC 184_ATM Data Service Provider for ATC services in a Virtual Centre context ER APP ATC 185_ATM Data Service Provider for Voice services in a Virtual Centre context
<ALLOCATED_TO>	<System>	ADSP ATC (PJ.10-93) ADSP Voice (PJ.10-93)

[REQ]

Identifier	REQ-16-03-NFR-DAT.0003
Title	Data Reporting – data retention
Requirement	Data stored in the Data Storage Repository shall be retained for adaptable period of years, unless otherwise specified.
Status	<in progress>
Rationale	All services are required to store service and security related data for a period of time stipulated by their regulatory authority. Hence this period needs to be adaptable.
Category	<Data>

[REQ Trace]

Relationship	Linked Element Type	Identifier
<ALLOCATED_TO>	<SESAR Solution>	PJ.10-W2-93A PJ.10-W2-93B PJ.10-W2-93C
<ALLOCATED_TO>	<Enabler>	ER APP ATC 184_ATM Data Service Provider for ATC services in a Virtual Centre context ER APP ATC 185_ATM Data Service Provider for Voice services in a Virtual Centre context
<ALLOCATED_TO>	<System>	ADSP ATC (PJ.10-93) ADSP Voice (PJ.10-93)

[REQ]

Identifier	REQ-16-03-NFR-DAT.0004
Title	Data Reporting - configurability

Requirement	It shall be possible to configure the surveillance service so that it also provides assured separation in accordance with the EUROCONTROL Specification for ATM Surveillance System Performance (Volume 1) EUROCONTROL-SPEC-0147.
Status	<in progress>
Rationale	Surveillance service should be configurable to provide required separation for the type of airspace i.e. appropriate data accuracy.
Category	<Data>

[REQ Trace]

Relationship	Linked Element Type	Identifier
<ALLOCATED_TO>	<SESAR Solution>	PJ.10-W2-93A PJ.10-W2-93B
<ALLOCATED_TO>	<Enabler>	ER APP ATC 184_ATM Data Service Provider for ATC services in a Virtual Centre context ER APP ATC 185_ATM Data Service Provider for Voice services in a Virtual Centre context SVC-028_Provision and Consumption of Surveillance Data Distribution Service
<ALLOCATED_TO>	<System>	ADSP ATC (PJ.10-93)
<ALLOCATED_TO>	<Service>	SurveillanceDataDistribution

4.2.2.6 Adaptability Requirements

[REQ]

Identifier	REQ-16-03-NFR-ADP.0001
Title	Adaptability
Requirement	Virtual Centre services shall be adaptable to meet the current and forecasted ATC expansion needs of the ANSP.
Status	<in progress>
Rationale	The capacity needs of the ANSP should be adaptable.
Category	<Adaptability>

[REQ Trace]

Relationship	Linked Element Type	Identifier

<ALLOCATED_TO>	<SESAR Solution>	PJ.10-W2-93A PJ.10-W2-93B
<ALLOCATED_TO>	<Enabler>	ER APP ATC 184_ATM Data Service Provider for ATC services in a Virtual Centre context ER APP ATC 185_ATM Data Service Provider for Voice services in a Virtual Centre context
<ALLOCATED_TO>	<System>	ADSP ATC (PJ.10-93) ADSP Voice (PJ.10-93)

[REQ]

Identifier	REQ-16-03-NFR-ADP.0002
Title	Surveillance Operational Capacity Adaptation
Requirement	The track data processing capacity shall be an adaptable number of tracks per track cycle from each track source.
Status	<in progress>
Rationale	The track processing capacity shall be adaptable to allow for the needs of individual ANSPs.
Category	<Adaptability>

[REQ Trace]

Relationship	Linked Element Type	Identifier
<ALLOCATED_TO>	<SESAR Solution>	PJ.10-W2-93A PJ.10-W2-93B
<ALLOCATED_TO>	<Enabler>	ER APP ATC 184_ATM Data Service Provider for ATC services in a Virtual Centre context ER APP ATC 185_ATM Data Service Provider for Voice services in a Virtual Centre context SVC-028_Provision and Consumption of Surveillance Data Distribution Service
<ALLOCATED_TO>	<System>	ADSP ATC (PJ.10-93)
<ALLOCATED_TO>	<Service>	SurveillanceDataDistribution

[REQ]

Identifier	REQ-16-03-NFR-ADP.0003
Title	Surveillance Operational Capacity Adaptation

Requirement	There shall be a track update rate, for each track source, defined in adaptation and the minimum possible value each update rate can be adapted to shall be 3s.
Status	<in progress>
Rationale	Track update rates are set depending of the underlying plot service. This requirement allows the service provider to set a minimum or lower band value.
Category	<Adaptability>

[REQ Trace]

Relationship	Linked Element Type	Identifier
<ALLOCATED_TO>	<SESAR Solution>	PJ.10-W2-93A PJ.10-W2-93B
<ALLOCATED_TO>	<Enabler>	ER APP ATC 184_ATM Data Service Provider for ATC services in a Virtual Centre context ER APP ATC 185_ATM Data Service Provider for Voice services in a Virtual Centre context SVC-028_Provision and Consumption of Surveillance Data Distribution Service
<ALLOCATED_TO>	<System>	ADSP ATC (PJ.10-93) ADSP Voice (PJ.10-93)
<ALLOCATED_TO>	<Service>	SurveillanceDataDistribution

4.2.2.7 Maintainability Requirements

[REQ]

Identifier	REQ-16-03-NFR-DAT.0001
Title	Maintainability of service
Requirement	Virtual Centre service shall be “restored” to normal working after a failure with the mean time to restore required by the Operational capabilities.
Status	<in progress>
Rationale	The service needs to demonstrate that it is maintainable following a failure in accordance with service management process.
Category	<Maintainability>

[REQ Trace]

Relationship	Linked Element Type	Identifier
<ALLOCATED_TO>	<SESAR Solution>	PJ.10-W2-93A PJ.10-W2-93B
<ALLOCATED_TO>	<Enabler>	ER APP ATC 184_ATM Data Service Provider for ATC services in a Virtual Centre context ER APP ATC 185_ATM Data Service Provider for Voice services in a Virtual Centre context
<ALLOCATED_TO>	<System>	ADSP ATC (PJ.10-93) ADSP Voice (PJ.10-93)

4.2.2.8 Regulation Requirements

[REQ]

Identifier	REQ-16-03-NFR-REG.0001
Title	Regulation and Legislation
Requirement	Each service shall assess and comply with the applicable interoperability, service provision, airspace, EASA and local regulatory authority regulations.
Status	<in progress>
Rationale	Need to demonstrate regulatory compliance.
Category	

[REQ Trace]

Relationship	Linked Element Type	Identifier
<ALLOCATED_TO>	<SESAR Solution>	PJ.10-W2-93A PJ.10-W2-93B
<ALLOCATED_TO>	<Enabler>	ER APP ATC 184_ATM Data Service Provider for ATC services in a Virtual Centre context ER APP ATC 185_ATM Data Service Provider for Voice services in a Virtual Centre context
<ALLOCATED_TO>	<System>	ADSP ATC (PJ.10-93) ADSP Voice (PJ.10-93)

5 Recommendation for Implementation

There is not a preferred architecture for processing delegations. The choice of the architecture is first the choice mutually adopted between 2 partners involved in the delegation.

Obviously, if the 2 partners are already sharing a common ADSP as a result of rationalization of infrastructure, then the delegation with “Y” architecture will be straight forward.

The existing standardisation of the services between the ATSU and their respective ADSPs will favour the set-up of a “D” architecture.

Existing prior agreements for AoR extension (i.e. legacy contingency), and/or expectations in flow management reorganisation are factors in favour of the “U” architecture, as well as the involvement of non-virtual centre systems.

It must be noted that the architectures are not mutually exclusive. Despite this would be a challenging configuration to set-up, from a logical point of view it is possible to have an ATSU running in a “Y” architecture and also supporting both “D” and “U” architectures for processing delegations with different neighbours ATSU that would not be included in the “Y”.

6 Assumptions

Service specific assumptions have been developed for each VC service and are documented in the service requirement chapters (4.2.1.x.2)

7 References and Applicable Documents

7.1 Applicable Documents

Content Integration

1. PJ19 W2 CI D2.15 - EATMA Guidance 2020
2. EATMA Community pages
3. SESAR ATM Lexicon

System and Service Development

5. ICAO AIRM v1.0.0
6. B.04.03 D102 SESAR Working Method on Services
7. PJ19 W2 CI D2.3 ADD 2020

Validation

22. European Operational Concept Validation Methodology (E-OCVM) - 3.0 [February 2010]

System Engineering

25. SESAR 2020 Requirements and Validation Guidelines Wave 2

Safety

26. SESAR, Safety Reference Material, Edition 4.1, December 2018
27. SESAR, Guidance to Apply the Safety Reference Material, Edition 3.1, December 2018
28. SESAR, Final Guidance Material to Execute Proof of Concept, Ed00.04.00, August 2015
29. SESAR, Resilience Engineering Guidance, May 2016

Human Performance

30. SESAR HP Assessment Process V1 to V3, Ed 3.1, January 2020

Environment Assessment

32. SESAR Environment Assessment Process, Ed 4.0 September 2019
33. ICAO CAEP – “Guidance on Environmental Assessment of Proposed Air Traffic Management Operational Changes” document, Doc 10031.

Security

34. Security Risk Assessment Methodology for SESAR 2020, Ed 2.0, September 2017

7.2 Reference Documents

37. SESAR Solution PJ.10-W2-Solution 93 Final SPR-INTEROP/OSED for V3 (D3.2.030)
38. SESAR 2020 TS-IRS - PJ.16-03 Solution (D2.3.010)
39. SESAR 2020 PJ.10-W2-93A Final TS/IRS TRL6 (and 93B, 93C TRL4) - Part II - Safety Assessment Report

Appendix A Appendices

A.1 Solutions Related Functional Blocks/Roles & Enablers

PJ.10-W2-93A / POI-0075 “Y”

SESAR Solution ID and Title	Functional Blocks/Role impacted by the SESAR Solution (from EATMA)	Enabler ID (from EATMA)	Enabler Title (from EATMA)	Initial Maturity	Target Maturity	Enabler Compulsory
PJ.10-W2-93A	Flight Planning - Lifecycle Management - Data Distribution	SVC-008	Provision and Consumption of FlightDataDistribution Service in the context of Virtual Centres.	TRL6	TRL6	Optional
PJ.10-W2-93A	Flight Planning - Lifecycle Management - Data Distribution	SVC-009	Provision and Consumption of FlightDataManagement Service in the context of Virtual Centres	TRL6	TRL6	Optional
PJ.10-W2-93A	Coordination and Transfer	SVC-010	Provision and Consumption of CoordinationAndTransferManagement Service in the context of Virtual Centres	TRL6	TRL6	Optional
PJ.10-W2-93A	Support Functions	SVC-013	Provision and Consumption of Airspace Status Distribution Service	TRL6	TRL6	Optional
PJ.10-W2-93A	Arrival Management	SVC-014	Provision and Consumption of Arrival Sequence Distribution Service	TRL4	TRL4	Optional
PJ.10-W2-93A	Arrival Management	SVC-015	Provision and Consumption of Arrival Sequence Management Service	TRL4	TRL4	Optional
PJ.10-W2-93A	Correlation Management	SVC-016	Provision and Consumption of Correlation Distribution Service	TRL6	TRL6	Optional

PJ.10-W2-93A	Correlation Management	SVC-017	Provision and Consumption of Correlation Management Service	TRL6	TRL6	Optional
PJ.10-W2-93A	Conflict Management	SVC-018	Provision and Consumption of Medium Term Conflict Detection Distribution Service	TRL4	TRL4	Optional
PJ.10-W2-93A	Conflict Management	SVC-019	Provision and Consumption of Medium Term Conflict Management Service	TRL4	TRL4	Optional
PJ.10-W2-93A	Monitoring Aids	SVC-020	Provision and Consumption of Monitoring Aids Distribution Service	TRL4	TRL6	Optional
PJ.10-W2-93A	Operational Supervision	SVC-021	Provision and Consumption of Operational Configuration Distribution Service	TRL4	TRL6	Optional
PJ.10-W2-93A	Operational Supervision	SVC-049	Operational Configuration Distribution of Working Position Preview Mode, and Neighbouring ATSU Sector configuration for ATM Service Delegation	new	TRL6	Optional
PJ.10-W2-93A	Operational Supervision	SVC-022	Provision and Consumption of Operational Configuration Management Service	TRL4	TRL6	Optional
PJ.10-W2-93A	Operational Supervision	SVC-050	Operational Configuration Management of Working Position Preview Mode, and Neighbouring ATSU Sectors for ATM Service Delegation	new	TRL6	Optional
PJ.10-W2-93A	Safety Nets	SVC-023	Provision and Consumption of Safety Net (SNET) Alert Distribution Service	TRL4	TRL4	Optional
PJ.10-W2-93A	Code Management	SVC-024	Provision and Consumption of SSR Code Distribution Service	TRL4	TRL4	Optional
PJ.10-W2-93A	Code Management	SVC-025	Provision and Consumption of SSR Code Management Service	TRL4	TRL4	Optional

PJ.10-W2-93A	Support Functions	SVC-026	Provision and Consumption of Support Functions Distribution Service	TRL4	TRL4	Optional
PJ.10-W2-93A	Support Functions	SVC-027	Provision and Consumption of Support Functions Management Service	TRL4	TRL4	Optional
PJ.10-W2-93A	Surveillance	SVC-028	Provision and Consumption of Surveillance Data Distribution Service	TRL4	TRL4	Optional
PJ.10-W2-93A	Technical Supervision	SVC-029	Provision and Consumption of Technical Supervision Distribution Service	TRL4	TRL6	Optional
PJ.10-W2-93A	Arrival Management , Monitoring Aids	SVC-031	Provision and Consumption of Time-based Separation Distribution Service	TRL4	TRL4	Optional
PJ.10-W2-93A	Arrival Management , Monitoring Aids	SVC-032	Provision and Consumption of Time-based Separation Management Service	TRL4	TRL4	Optional
PJ.10-W2-93A	A/G Voice Communication, G/G Voice Communication	SVC-033	Provision and Consumption of Voice Comm Information Distribution Service	TRL6	TRL6	Optional
PJ.10-W2-93A	A/G Voice Communication, G/G Voice Communication	SVC-034	Provision and Consumption of Voice Comm Management Service	TRL6	TRL6	Optional
PJ.10-W2-93A	ADSP ATC	ER APP ATC 184	ATM Data Service Provider for ATC services in a Virtual Centre context	TRL6	TRL6	Required
PJ.10-W2-93A	ADSP Voice	ER APP ATC 185	ATM Data Service Provider for Voice services in a Virtual Centre context	TRL6	TRL6	Required
PJ.10-W2-93A	VC ATSU	ER APP	Virtual Centre ATSU	TRL6	TRL6	Required

		ATC 186				
PJ.10-W2-93A	OPSUP HMI, CHMI	ER APP ATC 193	Management in the VC ATSU of a CWP preview mode during delegation of ATS Provision between ATUs	new	TRL6	Required
PJ.10-W2-93A	OPSUP, TP&M	ER APP ATC 194	Management in the ADSP of a CWP preview mode during delegation of ATS Provision between ATUs	new	TRL6	Required
PJ.10-W2-93A	CHMI	ER APP ATC 195	Management in the VC ATSU of Delegation of ATS Provision between ATUs with Static AoRs for Y-Architecture	new	TRL6	Required
PJ.10-W2-93A	ADSP ATC, ADSP Voice	ER APP ATC 216	Management in the ADSP of Delegation of ATS provision between ATUs with Static AoRs in a Y-Architecture	new	TRL6	Required
PJ.10-W2-93A	OPSUP HMI, SUPP HMI, CHMI	ER APP ATC 218	Management in the VC ATSU of Delegation of ATS provision between ATUs with Dynamic AoRs in a Y-Architecture	new	TRL6	Optional
PJ.10-W2-93A	OPSUP, SUPP	ER APP ATC 209	Management in the ADSP of Delegation of ATS provision between ATUs with Dynamic AoRs in a Y-Architecture	new	TRL6	Optional
PJ.10-W2-93A	Any Service	STD-097	EUROCAE ER for Taxonomy of Services between ATSU & ADSP(s), and between ADSP &ADSP	TRL4	TRL4	Optional

PJ.10-W2-93B / POI-0076 “D”

SESAR Solution ID and Title	Functional Blocks/Role impacted by the SESAR Solution (from EATMA)	Enabler ID (from EATMA)	Enabler Title (from EATMA)	Initial Maturity	Target Maturity	Enabler Compulsory

PJ.10-W2-93B	Flight Planning - Lifecycle Management - Data Distribution	SVC-008	Provision and Consumption of FlightDataDistribution Service in the context of Virtual Centres.	TRL6	TRL6	Optional
PJ.10-W2-93B	Flight Planning - Lifecycle Management - Data Distribution	SVC-009	Provision and Consumption of FlightDataManagement Service in the context of Virtual Centres	TRL6	TRL6	Optional
PJ.10-W2-93B	Coordination and Transfer	SVC-010	Provision and Consumption of CoordinationAndTransferManagement Service in the context of Virtual Centres	TRL6	TRL6	Optional
PJ.10-W2-93B	Support Functions	SVC-013	Provision and Consumption of Airspace Status Distribution Service	TRL6	TRL6	Optional
PJ.10-W2-93B	Arrival Management	SVC-014	Provision and Consumption of Arrival Sequence Distribution Service	TRL4	TRL4	Optional
PJ.10-W2-93B	Arrival Management	SVC-015	Provision and Consumption of Arrival Sequence Management Service	TRL4	TRL4	Optional
PJ.10-W2-93B	Correlation Management	SVC-016	Provision and Consumption of Correlation Distribution Service	TRL6	TRL6	Optional
PJ.10-W2-93B	Correlation Management	SVC-017	Provision and Consumption of Correlation Management Service	TRL6	TRL6	Optional
PJ.10-W2-93B	Conflict Management	SVC-018	Provision and Consumption of Medium Term Conflict Detection Distribution Service	TRL4	TRL4	Optional
PJ.10-W2-93B	Conflict Management	SVC-019	Provision and Consumption of Medium Term Conflict Management Service	TRL4	TRL4	Optional
PJ.10-W2-93B	Monitoring Aids	SVC-020	Provision and Consumption of Monitoring Aids Distribution Service	TRL4	TRL6	Optional

PJ.10-W2-93B	Operational Supervision	SVC-021	Provision and Consumption of Operational Configuration Distribution Service	TRL4	TRL6	Optional
PJ.10-W2-93B	Operational Supervision	SVC-049	Operational Configuration Distribution of Working Position Preview Mode, and Neighbouring ATSU Sector configuration for ATM Service Delegation	new	TRL6	Optional
PJ.10-W2-93B	Operational Supervision	SVC-022	Provision and Consumption of Operational Configuration Management Service	TRL4	TRL6	Optional
PJ.10-W2-93B	Operational Supervision	SVC-050	Operational Configuration Management of Working Position Preview Mode, and Neighbouring ATSU Sectors for ATM Service Delegation	new	TRL6	Optional
PJ.10-W2-93B	Safety Nets	SVC-023	Provision and Consumption of Safety Net (SNET) Alert Distribution Service	TRL4	TRL4	Optional
PJ.10-W2-93B	Code Management	SVC-024	Provision and Consumption of SSR Code Distribution Service	TRL4	TRL4	Optional
PJ.10-W2-93B	Code Management	SVC-025	Provision and Consumption of SSR Code Management Service	TRL4	TRL4	Optional
PJ.10-W2-93B	Support Functions	SVC-026	Provision and Consumption of Support Functions Distribution Service	TRL4	TRL4	Optional
PJ.10-W2-93B	Support Functions	SVC-027	Provision and Consumption of Support Functions Management Service	TRL4	TRL4	Optional
PJ.10-W2-93B	Surveillance	SVC-028	Provision and Consumption of Surveillance Data Distribution Service	TRL4	TRL4	Optional
PJ.10-W2-93B	Technical Supervision	SVC-029	Provision and Consumption of Technical Supervision Distribution Service	TRL4	TRL6	Optional

PJ.10-W2-93B	Arrival Management , Monitoring Aids	SVC-031	Provision and Consumption of Time-based Separation Distribution Service	TRL4	TRL4	Optional
PJ.10-W2-93B	Arrival Management , Monitoring Aids	SVC-032	Provision and Consumption of Time-based Separation Management Service	TRL4	TRL4	Optional
PJ.10-W2-93B	A/G Voice Communication, G/G Voice Communication	SVC-033	Provision and Consumption of Voice Comm Information Distribution Service	TRL6	TRL6	Optional
PJ.10-W2-93B	A/G Voice Communication, G/G Voice Communication	SVC-034	Provision and Consumption of Voice Comm Management Service	TRL6	TRL6	Optional
PJ.10-W2-93B	ADSP ATC	ER APP ATC 184	ATM Data Service Provider for ATC services in a Virtual Centre context	TRL6	TRL6	Required
PJ.10-W2-93B	ADSP Voice	ER APP ATC 185	ATM Data Service Provider for Voice services in a Virtual Centre context	TRL6	TRL6	Required
PJ.10-W2-93B	VC ATSU ATC	ER APP ATC 186	Virtual Centre ATSU	TRL6	TRL6	Required
PJ.10-W2-93B	OPSUP HMI, CHMI	ER APP ATC 193	Management in the VC ATSU of a CWP preview mode during delegation of ATS Provision between ATUs	new	TRL6	Optional
PJ.10-W2-93B	OPSUP, TP&M	ER APP ATC 194	Management in the ADSP of a CWP preview mode during delegation of ATS Provision between ATUs	new	TRL6	Optional
PJ.10-W2-93B	CHMI, OPSUPHMI, Technical	ER APP ATC 215	Management in the VC ATSU of Delegation of ATS Provision between ATUs with Static AoRs in a D-Architecture	new	TRL4	Required

	Supervision HMI					
PJ.10-W2-93B	ADSP Voice, ADSP ATC	ER APP ATC 217	Management in the ADSP of Delegation of ATS provision between ATUs with Static AoRs in a D-Architecture	new	TRL4	Required
PJ.10-W2-93A	Any Service	STD-097	EUROCAE ER for Taxonomy of Services between ATSU & ADSP(s), and between ADSP &ADSP	TRL4	TRL4	Optional

PJ.10-W2-93C / POI-0077 “U”

SESAR Solution ID and Title	Functional Blocks/Role impacted by the SESAR Solution (from EATMA)	Enabler ID (from EATMA)	Enabler Title (from EATMA)	Initial Maturity	Target Maturity	Enabler Compulsory
PJ.10-W2-93C	OPSUP HMI, CHMI	ER APP ATC 193	Management in the VC ATSU of a CWP preview mode during delegation of ATS Provision between ATUs	new	TRL6	Optional
PJ.10-W2-93C	OPSUP, TP&M	ER APP ATC 194	Management in the ADSP of a CWP preview mode during delegation of ATS Provision between ATUs	new	TRL6	Optional
PJ.10-W2-93C	CHMI, OPSUP HMI, SUPP HMI	ER APP ATC 196	Management in the VC ATSU of Delegation of ATS provision between ATUs with Dynamic AoRs	new	TRL4	Required

PJ.10-W2-93C	AGDL, CTM, FPLD, G/G Voice, GGCD, OPSUP, SUPP	ER APP ATC 197	Management in the ADSP of Delegation of ATS provision between ATUs with Dynamic AoRs	new	TRL4	Required
--------------	---	----------------	--	-----	------	----------

A.2 Service Description Document (SDD)

The Service Description Document (SDD) describes logical services defined by PJ.16-03 and updated in the context of PJ.10-W2-93 or PJ.32-W3-02.

All the SDDs are organised as follows:

- The “Introduction” section presents the purpose of the SDD, the intended readership and the glossary of terms;
- The “Service Identification” section identifies the version and date of the SDD;
- The “Operational and Business Context” section is common to all SDDs;
- The “Service Overview” briefly presents the service interfaces;
- The “Service Interface Specifications” details for each service interface the input/output parameters of the operations;
- The “Payload Data Diagrams” contains the MEGA representation of the service payload; both Core and Extensions;
- The “Payload Data Types” defines in two separate tables the ‘terminal’ data types, e.g. character strings, integers, floats or Boolean and the ‘compound’ data types;
- The “Payload Elements” provides the various elements defining the payloads of the service operations;
- The “Service dynamic behaviour” describes the way the service is operated by the VC ATSUs and the ADSPs. This section is complemented in the TS/IRS main body section 4.2.1 “Functional Requirements”.

A.2.1 Airspace Status Distribution (ASD) [PJ.32-W3-02]



PJ32-WP3 SDD
AirspaceStatusDistri

A.2.2 Coordination and Transfer Management Service (CTM) [PJ.32-W3-02]



PJ32-WP3 SDD
CoordinationAndTr:

A.2.3 Correlation Distribution (CORRD) [PJ.32-W3-02]



PJ32-WP3 SDD
CorrelationDistribut

A.2.4 Correlation Management (CORRM) [PJ.32-W3-02]



PJ32-WP3 SDD
CorrelationManager

A.2.5 Flight Data Management Service (FDM) [PJ.32-W3-02]



PJ32-WP3 SDD
FlightDataManager

A.2.6 Flight Data Distribution Service (FDD) [PJ.32-W3-02]



PJ32-WP3 SDD
FlightDataDistributi

A.2.7 Medium Term Conflict Detection (MTCDD) [PJ.32-W3-02]



PJ32-WP3 SDD
MediumTermConflic

A.2.8 Medium Term Conflict Management (MTCDM) [PJ.32-W3-02]



PJ32-WP3 SDD
FlightDataManager

A.2.9 Monitoring Aids Distribution (MONA) [PJ.32-W3-02]



PJ32-WP3 SDD
MonitoringAidsDist

A.2.10 Operational Configuration Management Service (OPCONFM)



PJ10-93 SDD
OperationalConfigu

A.2.11 Operational Configuration Distribution Service (OPCONFD)



PJ10-93 SDD
OperationalConfigu

A.2.12 Safety Net Alert Service (SNET) [PJ.32-W3-02]



PJ32-WP3 SDD
SNETAlertDistributic

A.2.13 SSR Code Distribution (SSRCD) [PJ.32-W3-02]



PJ32-WP3 SDD
SSRCodeDistributio

A.2.14 SSR Code Management (SSRCM) [PJ.32-W3-02]



PJ32-WP3 SDD
SSRCodeManageme

A.2.15 Technical Supervision Distribution (TECHSUPD) [PJ.32-W3-02]



PJ32-WP3 SDD
TechnicalSupervisio

A.3 Time Performances Analysis

This section provides the times references used by the requirements of section 4.2.1.2.

A.3.1 OPCONFM and OPCONFD services

The Operational Configuration Management service allows an ACC/Approach operational supervisor to reflect the current radio frequency allocation and the sector configuration operated in the ATSU within the centre configuration information managed by the ADSP.

The Operational Configuration Distribution service dynamically notifies subscribed users about radio frequency allocation and sector configuration information within a given ATSU.

The table below identifies the times associated with the OPCONF service operations and assigns a time profile.

Identifier	Definition	Type	Time Profile
OPS times			
TT-OPS-OPCONFM-001	Time for the supervisor to update the operational configuration (radio frequency, sector configuration) and receive a configuration data update	Operational Transaction Time	Category 'time sensitive'
DT-OPS-OPCONFD-001	Time between the ADSP detects new operational configuration data for an ATSU and the information is displayed on the WP of the operator.	Operational Delivery Time	Category 'time sensitive'
TECH Times			
TT-TECH-OPCONFD-001	Time for the VC ATSU to subscribe/unsubscribe to the Operational Configuration Distribution service.	Technical Transaction time	Category 'time sensitive'
DT-TECH-OPCONFD-001	Time between the ADSP sends the operational configuration data and it is received by the VC ATSU	Technical Delivery Time	Category 'time sensitive'

Table 20: [OPCONF] Response and Transit Times